

ADAM-6060

ADAM-6066

6-ch Digital Input and 6-ch Relay
Modbus TCP Module

6-ch Digital Input and 6-ch Power Relay
Modbus TCP Module

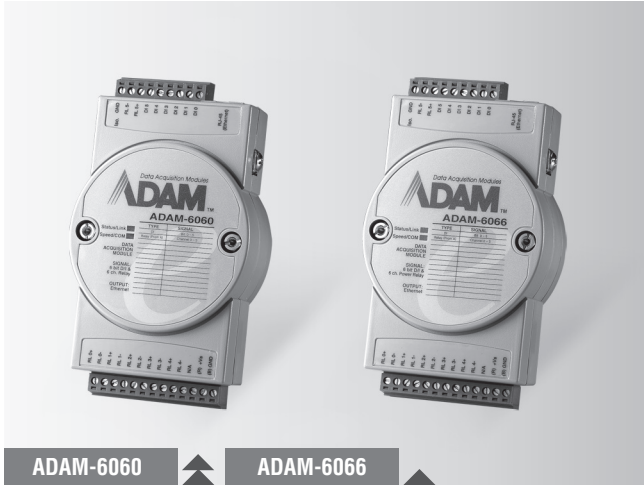

ADAM-6060

ADAM-6066



Specifications

General

- LAN 10/100Base-T(X)
- Power Consumption 2 W @ 24 V_{DC} (ADAM-6060)
2.5 W @ 24 V_{DC} (ADAM-6066)
- Connectors 1 x RJ-45 (LAN), Plug-in screw terminal block (I/O and power)
- Watchdog Timer System (1.6 second) and Communication (programmable)
- Power Input 10 ~ 30 V_{DC}
- Supports Peer-to-Peer
- Supports GCL
- Supports Modbus/TCP, TCP/IP, UDP and HTTP Protocols

Digital Input

- Channels 6
- Dry Contact Logic level 0: close to GND
Logic level 1: open
- Wet Contact Logic level 0: 3 V_{DC}
Logic level 1: 10 ~ 30 V_{DC}
- Supports 3 kHz Counter Input (32-bit + 1-bit overflow)
- Keep/Discard Counter Value when Power-off
- Supports 3 kHz Frequency Input
- Supports Inverted DI Status

Relay Output (Form A)

- Channels 6
- Contact Rating (Resistive) ADAM-6060: 120 V_{AC} @ 0.5 A
30 V_{DC} @ 1 A
ADAM-6066: 250 V_{AC} @ 5 A
30 V_{DC} @ 3 A
- Breakdown Voltage 500 V_{AC} (50/60 Hz)
- Relay On Time 7 ms
- Relay Off Time 3 ms
- Total Switching Time 10 ms
- Insulation Resistance 1 GΩ min. at 500 V_{DC}
- Maximum Switching Rate (at rated load) 20 operations/minute
- Supports Pulse Output

Protection

- Isolation Voltage 2,000 V_{DC}
- Power Reversal Protection

Environment

- Operating Temperature -10 ~ 70°C (14 ~ 158°F)
- Storage Temperature -20 ~ 80°C (-4 ~ 176°F)
- Operating Humidity 20 ~ 95% RH (non-condensing)
- Storage Humidity 0 ~ 95% RH (non-condensing)

Ordering Information

- ADAM-6060 6-ch DI and 6-ch Relay Modbus TCP Module
- ADAM-6066 6-ch DI and 6-ch Power Relay Modbus TCP Module

ADAM-6000 Series Dimensions

Unit: mm

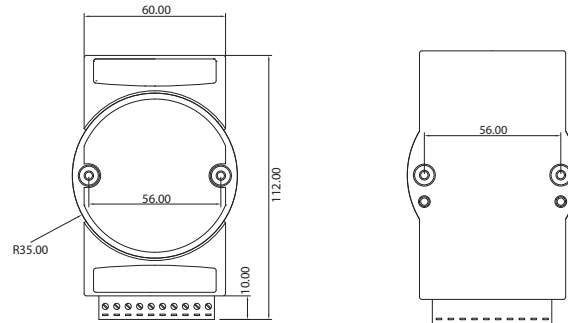

Front View

Rear View

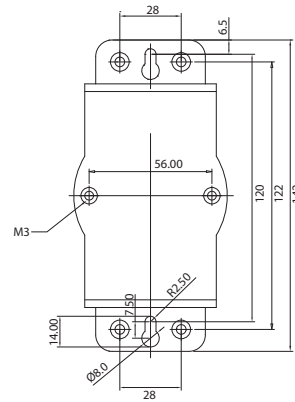

Wall Mounting View

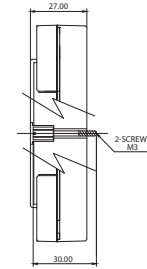

Side View

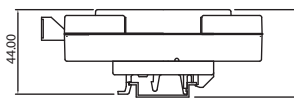

DIN-Rail Mounting View

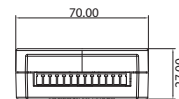

Top View

ADAM-6000 Series Common Specifications

General

- Dimensions (W x H x D) 70 x 120 x 30 mm
- Enclosure ABS+PC
- Mounting DIN 35 rail, stack, wall

Mouser Electronics

Authorized Distributor

Click to View Pricing, Inventory, Delivery & Lifecycle Information:

[Advantech:](#)

[ADAM-6066-CE](#)