

LED Driver

LNE-320W Series / LNE-□V320W□□A

LNE



Highlights & Features

- Meet ErP Directive (2009/125/EC) for International models (except 12V models)
- North American and International AC voltage options
- Up to 94.5% efficiency
- 6kV common mode & 4kV differential mode surge immunity
- Active PFC. Meets IEC/EN 61000-3-2, Class C
- Adjustable voltage & current; dimming options available
- IP65 or IP67 options for indoor and outdoor applications

Safety Standards



CB Certified for worldwide use



Package Type

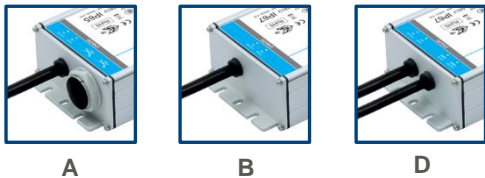

Model Number:	LNE-□V320W□□A
Unit Weight:	1.70kg (3.75 lb)
Dimensions (L x W x D):	252 x 90 x 43.8 mm (9.92 x 3.54 x 1.72 inch)

General Description

Delta LNE series of LED drivers comes with different combinations of features to suit different application requirements and energy optimization needs. Options include externally adjustable output voltage and current levels, and adjustment of LED brightness via 3-way built-in dimming function. All models in the LNE series come with full corrosion resistant aluminum casing, major international safety certifications and are compliant with EN55015 immunity/Emissions/Harmonic requirements. The products are designed and rigorously tested to work in various indoor and outdoor LED lighting conditions. High surge immunity (common mode: 6kV, differential mode: 4kV), MTBF > 700,000hrs and compliance to IP65/IP67, all make the Delta LNE series an essential part of an energy efficient LED lighting power solution for both indoor and outdoor applications.

Model Information

LNE LED Driver

Model Number	Input Voltage Range	Rated Output Voltage	Rated Output Current
LNE-12V320W□□A	90-305Vac (LNE-□V320W□AA)	12Vdc	22.50A
LNE-24V320W□□A	90-264Vac (LNE-□V320W□CA)	24Vdc	13.40A
LNE-36V320W□□A		36Vdc	8.90A
LNE-48V320W□□A		48Vdc	6.70A

Model Numbering

LN	E –	□V	320W	□	□	A
LED Driver	Product Series E – High efficiency and PFC	Output Voltage 12V 24V 36V 48V	Output Power (320W series model)	Package Type A – IP65 with potentiometers to adjust output voltage & constant current level B – IP67 without dimming cable & potentiometers D – IP67 with dimming cable to adjust constant current level	Safety Approval A – UL approval C – ENEC, CE and CCC approval	Variable A – Delta standard

LED Driver

LNE-320W Series / LNE-□V320W□□A

Specifications

Model Number		LNE-12V320W□	LNE-24V320W□	LNE-36V320W□	LNE-48V320W□
Input Ratings / Characteristics					
Nominal Input Voltage		100-277Vac (LNE-□V320W□AA, with UL approval) 100-240Vac (LNE-□V320W□CA, with ENEC, CE and CCC approval)			
Input Voltage Range*		90-305Vac (LNE-□V320W□AA, with UL approval) 90-264Vac (LNE-□V320W□CA, with ENEC, CE and CCC approval)			
Nominal Input Frequency		50-60 Hz			
Input Frequency Range		47-63 Hz			
Input Current		3.50A max. @ 115Vac, 1.65A max. @ 230Vac, 1.45A max. @ 277Vac			
Efficiency at 100% Load	115Vac	89.5% typ.	91.5% typ.	92.5% typ.	93.0% typ.
	230Vac	90.5% typ.	93.5% typ.	94.5% typ.	94.5% typ.
	277Vac	91.0% typ.	94.0% typ.	94.5% typ.	94.5% typ.
No load Power Consumption		< 0.64W @ 230Vac			
Max Inrush Current (Cold Start)		65A typ. @ 230Vac			
Maximum Number of LED Driver to Connect with Circuit Breaker		1 unit for 16A circuit breaker, characteristic B 2 units for 20A circuit breaker, characteristic C			
Power Factor at 100% Load		0.98 typ. @ 115Vac 0.95 typ. @ 230Vac 0.92 typ. @ 277Vac			
Total Harmonic Distortion		< 20% @ 115Vac/60 Hz & 230Vac/50 Hz & 277Vac/60 Hz (≥ 70% load)			
Leakage Current		< 0.75mA @ 277Vac			

* Output power is de-rated for input voltage lower than 100 Vac. Please refer to Fig. 2 on page 11.

LED Driver

LNE-320W Series / LNE-□V320W□□A

Power Factor Vs Output Load

LNE-12V320W□

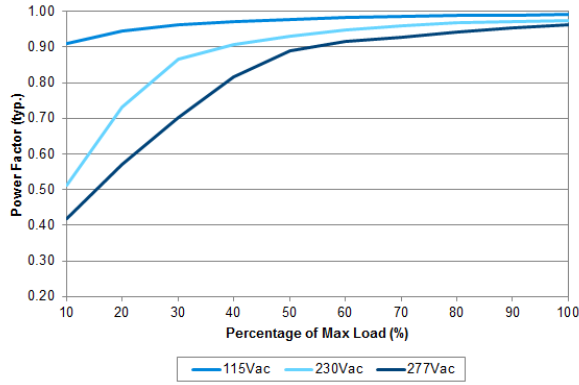

LNE-24V320W□

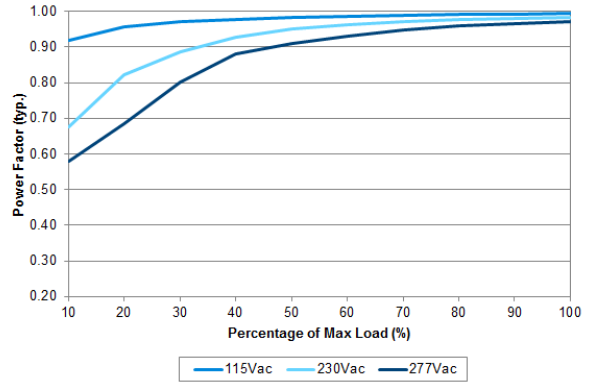

LNE-36V320W□

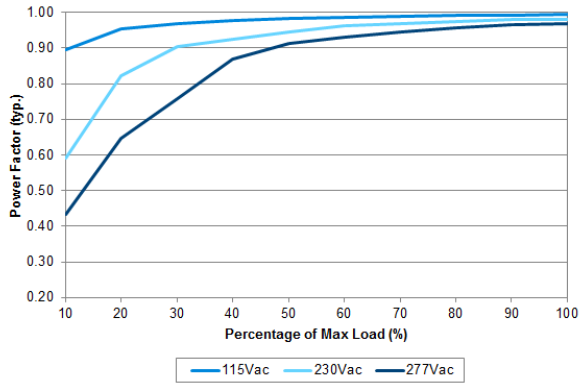

LNE-48V320W□

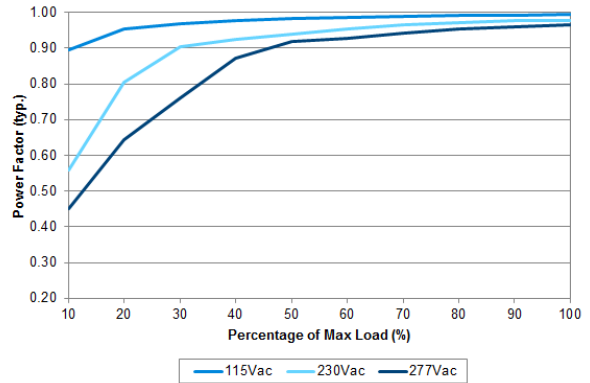

LED Driver

LNE-320W Series / LNE-□V320W□□A

Efficiency Vs Output Load at Nominal Output Voltage

LNE-12V320W□

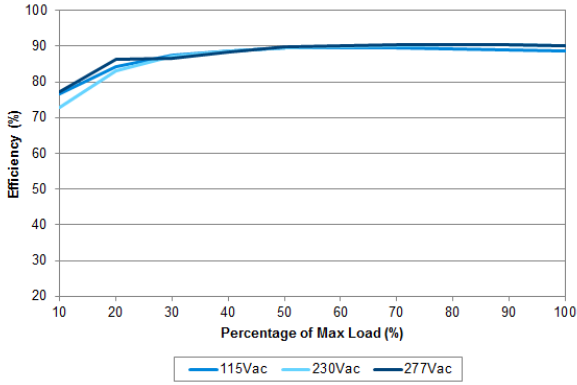

LNE-24V320W□

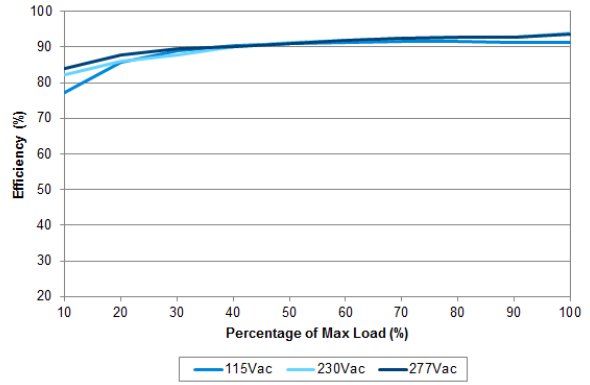

LNE-36V320W□

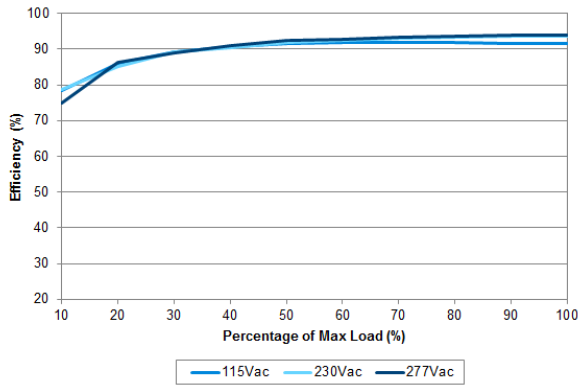

LNE-48V320W□

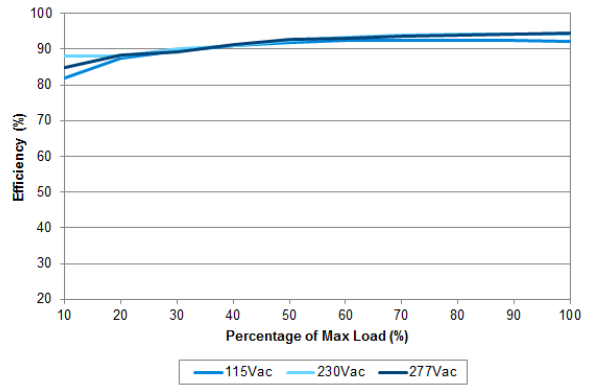

LED Driver**LNE-320W Series / LNE-□V320W□□A**

Model Number	LNE-12V320W□	LNE-24V320W□	LNE-36V320W□	LNE-48V320W□
--------------	--------------	--------------	--------------	--------------

Output Ratings / Characteristics*

Nominal Output Voltage	12Vdc	24Vdc	36Vdc	48Vdc
LED System Voltage Range in CC Mode	6-12Vdc	12-24Vdc	18-36Vdc	24-48Vdc
Output Voltage Adjustment Range**	10.8-13.5V	22.0-27.0V	33.0-40.0V	43.0-53.0V
Nominal Output Current	22.50A	13.40A	8.90A	6.70A
Output Current Adjustment Range**	11.25-22.5A	6.67-13.40A	4.45-8.90A	3.35-6.70A
Output Power	270W	320W	320W	320W
Line Regulation @ 90-305Vac (LNE-□V320W□AA) @ 90-264Vac (LNE-□V320W□CA)	± 0.5%			
Load Regulation (0-95% load) @ 90-305Vac (LNE-□V320W□AA) @ 90-264Vac (LNE-□V320W□CA)	± 2.0%	± 0.5%	± 0.5%	± 0.5%
PARD*** (20 MHz)	< 150mVpp	< 150mVpp	< 250mVpp	< 250mVpp
Rise Time	< 50ms @ 115Vac & 230Vac & 277Vac			
Start-up Time	< 1000ms @ 115Vac < 500ms @ 230Vac			
Hold-up Time	16ms typ. @ 115Vac & 230Vac & 277Vac (100% load)			
Dynamic Response (Overshoot & Undershoot O/P Voltage)	± 5% @ 0-90% load, @ 115Vac & 230Vac & 277Vac (Slew Rate: 0.1A/μS)			

* For power de-rating from 60°C to 70°C, see power de-rating at Fig.1 on page 11.

** For LNE-□V320WA□A package type only.

*** PARD is measured with an AC coupling mode, and in parallel with 0.1μF ceramic capacitor & 47μF electrolytic capacitor.

LED Driver

LNE-320W Series / LNE-□V320W□□A

Model Number	LNE-12V320W□	LNE-24V320W□	LNE-36V320W□	LNE-48V320W□
--------------	--------------	--------------	--------------	--------------

Mechanical

Casing		Aluminum		
Dimensions (L x W x D)		252 x 90 x 43.8 mm (9.92 x 3.54 x 1.72 inch)		
Unit Weight		1.70kg (3.75 lb)		
Cooling System		Convection		
Wire	Input	LNE-□V320W□CA	H05RN-F3G1.0mm ²	Line: Brown, Neutral: Blue, PE: Green/Yellow
		LNE-□V320W□AA	SJTW 18AWGX3C	Line: Brown, Neutral: Blue, PE: Green/Yellow
	Output	LNE-□V320W□CA	H07RN-F2x1.5mm ²	Positive: Red, Negative: Black
		LNE-□V320W□AA	SJTW 14AWGX2C	Positive: Red, Negative: Black
	Dimming	LNE-□V320W□CA	H05RN-F2x1.0mm ²	Positive: White, Negative: Blue
		LNE-□V320W□AA	SJTW 18AWGX2C	Positive: White, Negative: Blue
Noise (1 Meter from power supply)		Sound Pressure Level (SPL) < 25dBA		

Environment

Surrounding Air Temperature	Operating	-40°C to +70°C	
	Storage	-40°C to +85°C	
Power De-rating	Temperature	> 50°C de-rate power by 2% / °C	Label face down mounting orientation
		> 60°C de-rate power by 4% / °C	Other mounting orientations
	Input	< 100Vac de-rate power by 2% / Vac	
Operating Humidity		5 to 95% RH (Non-Condensing)	
Operating Altitude		0 to 3,000 Meters (9,840 ft.)	
Shock Test	Non-Operating	IEC 60068-2-27, Half Sine Wave: 50G for a duration of 11ms, 3shocks for each 3 directions	
Vibration	Non-Operating	IEC 60068-2-6, Random: 5 Hz to 500 Hz (2.09G); 20 min per axis for all X, Y, Z direction	
Pollution Degree		2	
Location Ratings (Included in UL safety approvals)		Dry, damp, wet ratings (LNE-□V320W□AA, with UL approval)	
Type H/L (Included in safety approvals)		UL Class I, Division 2 Hazardous Location	

Protections

Overvoltage	13.8-16.8V, Latch Mode	27.6-33.6V, Latch Mode	41.4-50.4V, Latch Mode	55.2-67.2V, Latch Mode
Overload / Overcurrent	95-108%of rated load current, constant current limit Auto-Recovery when the fault is removed			
Over Temperature	Hiccup Mode, Auto-Recovery when the fault is removed			
Short Circuit	Constant current limit , Auto-Recovery when the fault is removed			
Degree of Protection	IP65	LNE-□V320WA□A		
	IP67	LNE-□V320WB□A and LNE-□V320WD□A		
Protection Against Shock	Class I with PE* connection			

*PE: Primary Earth

LED Driver

LNE-320W Series / LNE-□V320W□□A

Model Number	LNE-12V320W□	LNE-24V320W□	LNE-36V320W□	LNE-48V320W□
--------------	--------------	--------------	--------------	--------------

Reliability Data

MTBF	> 700,000 hrs. as per Telcordia SR-332 (I/P: 115Vac, O/P: 100% load, Ta: 25°C)
Expected Cap Life Time	7 years (I/P: 115Vac & 230Vac, O/P: 100% load @ T case (tc) ≤ 75°C)

Safety Standards / Directives

Electrical Safety	CB scheme ENEC CCC	LNE-□V320W□CA: IEC 61347-1, IEC 61347-2-13 EN 61347-1, EN 61347-2-13, EN 62384 GB19510.1, GB19510.14
	UL/cUL recognized	LNE-□V320W□AA: UL 8750 and CAN/CSA C22.2 No. 60950-1 (Safety approval and dry, damp, wet ratings)
CE		LNE-12V320W□CA: In conformance with EMC Directive 2014/30/EU and Low Voltage Directive 2014/35/EU LNE-24V320W□CA, LNE-36V320W□CA, LNE-48V320W□CA: In conformance with EMC Directive 2014/30/EU and Low Voltage Directive 2014/35/EU ErP Directive 2009/125/EC to Commission Regulation (EU) No. 1194/2012
Material and Parts		RoHS Directive 2011/65/EU Compliant
Galvanic Isolation	Input to Output	3.85kVac
	Input to Ground	2.0kVac
	Output to Ground	1.5kVac

EMC

Emissions (CE & RE)		CISPR 15, EN 55015, GB17743 Compliance to CISPR 32, EN 55032, FCC Title 47: Class B
Immunity		EN 61547, Compliance to EN 55024
Electrostatic Discharge	IEC 61000-4-2	Level 4 Criteria A ¹⁾ Air Discharge: 15kV Contact Discharge: 8kV
Radiated Field	IEC 61000-4-3	Level 3 Criteria A ¹⁾ 80 MHz-1 GHz, 10V/M with 1 kHz tone / 80% modulation
Electrical Fast Transient / Burst	IEC 61000-4-4	Level 3 Criteria A ¹⁾ 2kV
Surge	IEC 61000-4-5	Level 5 Criteria A ¹⁾ Common Mode ³⁾ : 6kV Differential Mode ⁴⁾ : 4kV
Conducted	IEC 61000-4-6	Level 3 Criteria A ¹⁾ 150 kHz-80 MHz, 10Vrms
Power Frequency Magnetic Fields	IEC 61000-4-8	Level 3 Criteria A ¹⁾ 10A/Meter
Voltage Dips and Interruptions	IEC 61000-4-11	100% dip, 0.5 cycle, Criteria A ¹⁾ 30% dip, 10 cycle, Criteria B ²⁾ @ 100Vac 30% dip, 10 cycle, Criteria A ¹⁾ @ 230Vac
Harmonic Current Emission		IEC/EN 61000-3-2, Class C; GB17625.1
Voltage Fluctuation and Flicker		IEC/EN 61000-3-3

1) Criteria A: Normal performance within the specification limits

2) Criteria B: Temporary degradation or loss of function which is self-recoverable

3) Asymmetrical: Common mode (Line to earth)

4) Symmetrical: Differential mode (Line to line)

LED Driver

LNE-320W Series / LNE-□V320W□□A

Block Diagram

LNE-□V320WA□A and LNE-□V320WB□A

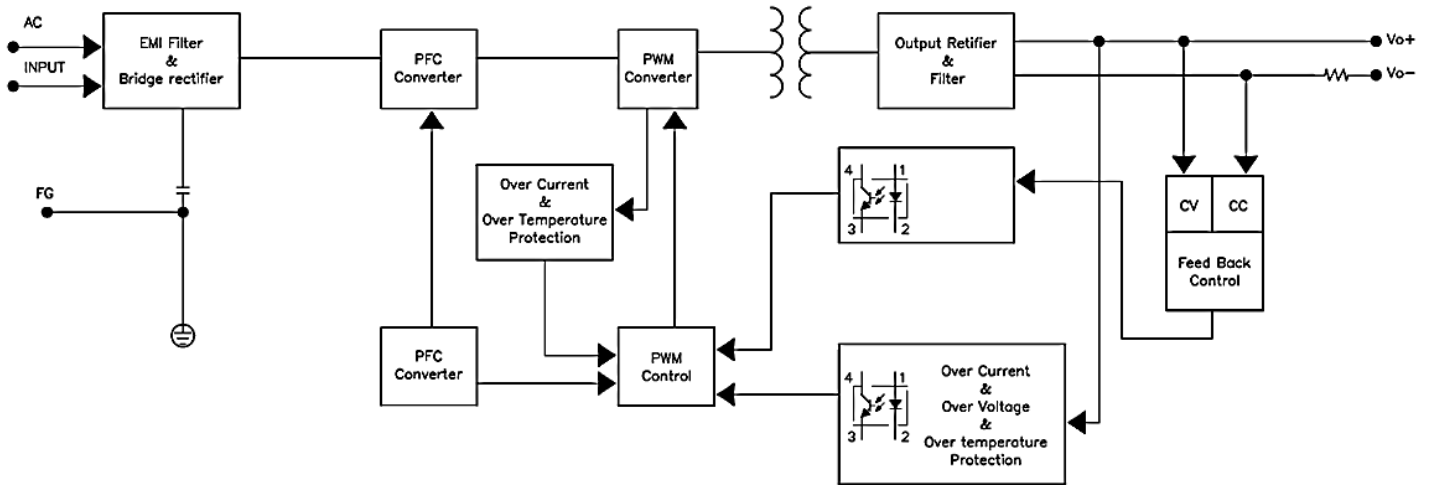

LNE-□V320WD□A

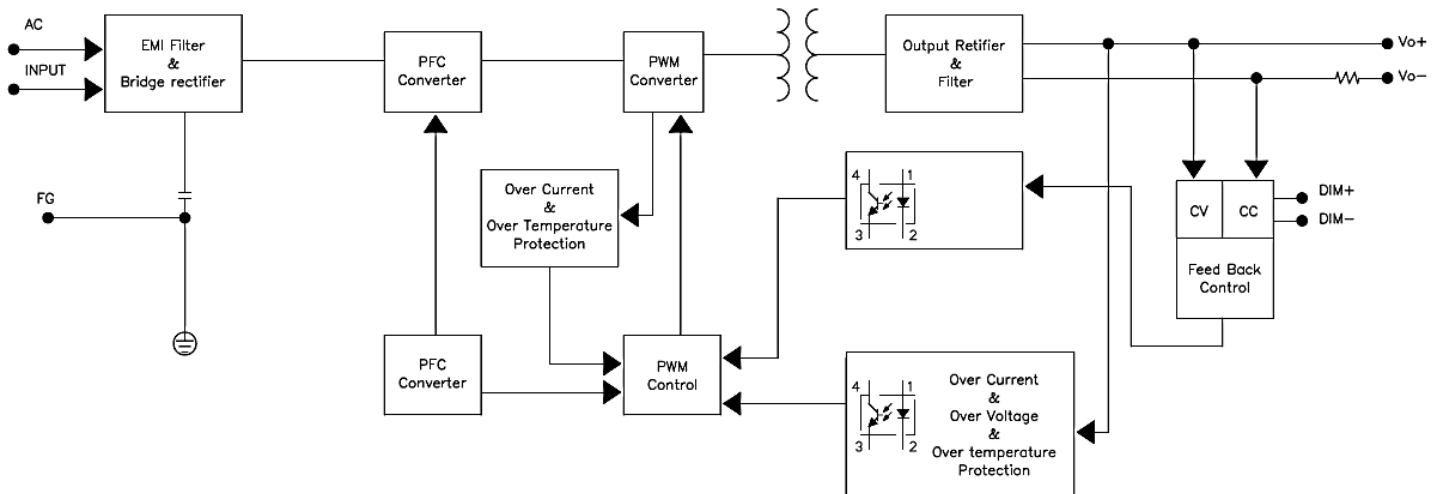

LED Driver

LNE-320W Series / LNE-□V320W□□A

Dimensions

L x W x D: 252 x 90 x 43.8 mm (9.92 x 3.54 x 1.72 inch)

LNE-□V320WA□A (IP65 with potentiometers to adjust output voltage & constant current level)

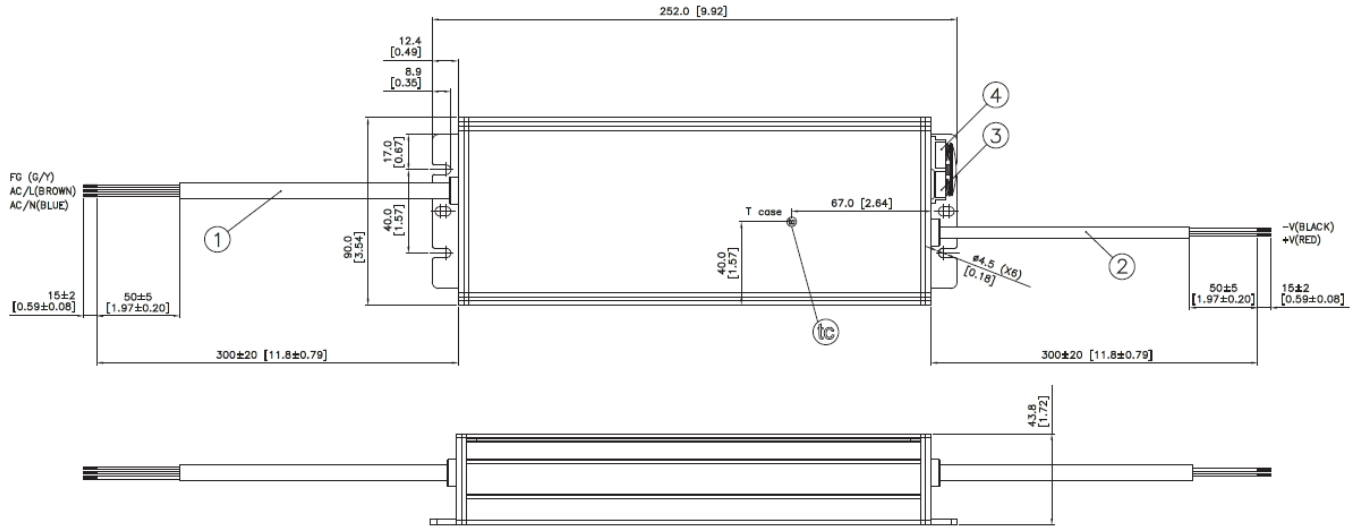

LNE-□V320WB□A (IP67 without dimming cable & potentiometers)

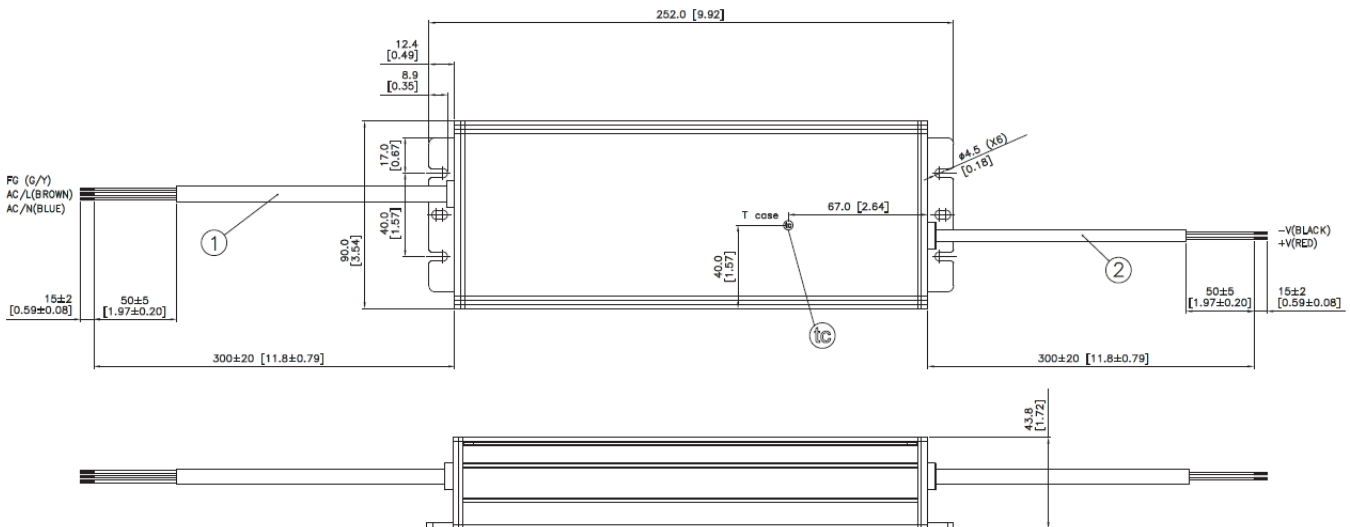

Item	Device Description
1	Input cable
2	Output cable
3	Constant voltage adjustment potentiometer
4	Constant current adjustment potentiometer
tc	T case (tc): Temperature hot spot location on case. The temperature at this location will not exceed 90°C when used in accordance to conditions in this data sheet.

LED Driver

LNE-320W Series / LNE-□V320W□□A

LNE-□V320WD□A (IP67 with dimming cable to adjust constant current level)

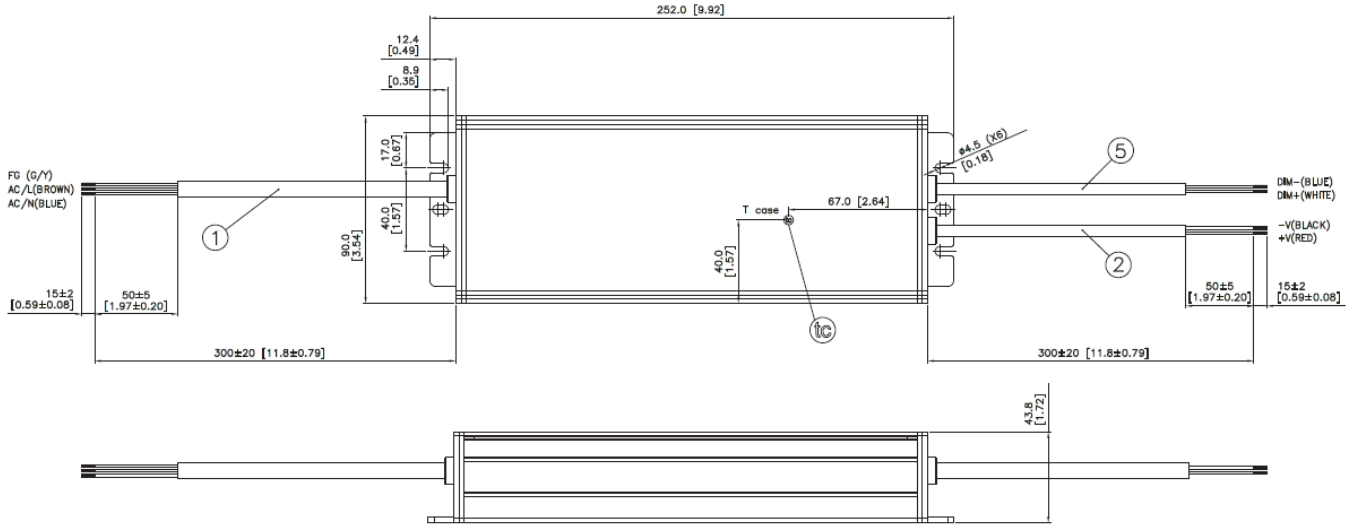

Item	Device Description
1	Input cable
2	Output cable
3	N/A
4	N/A
5	Dimming Cable
tc	T case (tc): Temperature hot spot location on case. The temperature at this location will not exceed 90°C when used in accordance to conditions in this data sheet.

LED Driver

LNE-320W Series / LNE-□V320W□□A

Engineering Data

Output Load De-rating VS Surrounding Air Temperature

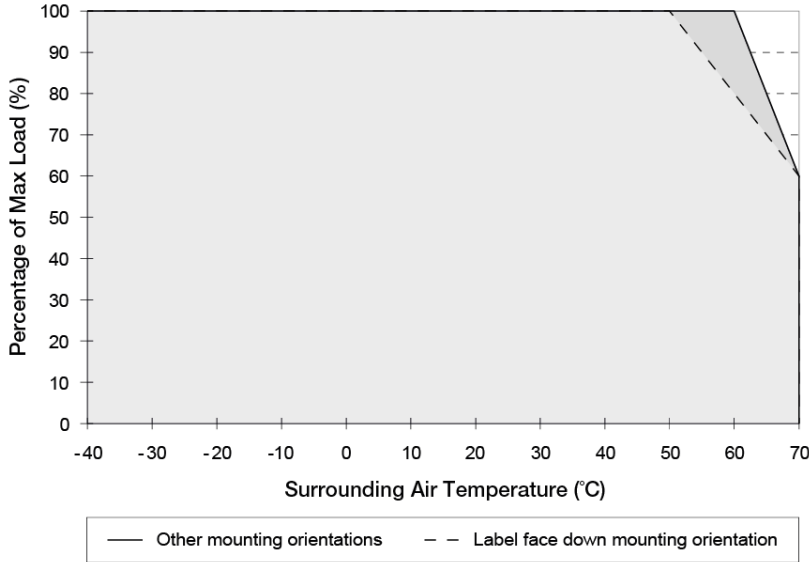

Note

1. Power supply components may degrade, or be damaged, when the power supply is continuously used outside the shaded region, refer to the graph shown in Fig. 1.
2. If the output capacity is not reduced when the surrounding air temperature > 50°C (Label face down mounting orientation) or > 60°C (Other mounting orientations), the device will run into Over Temperature Protection. When activated, the output voltage will go into bouncing mode and will recover when the surrounding air temperature is lowered or the load is reduced as far as necessary to keep the device in working condition.
3. Depending on the surrounding air temperature and output load delivered by the power supply, the device can be very hot!

Fig. 1 De-rating for Label face down mounting orientation

> 50°C de-rate power by 2% / °C

De-rating for Other mounting orientations

> 60°C de-rate power by 4% / °C

Output Load De-rating VS Input Voltage

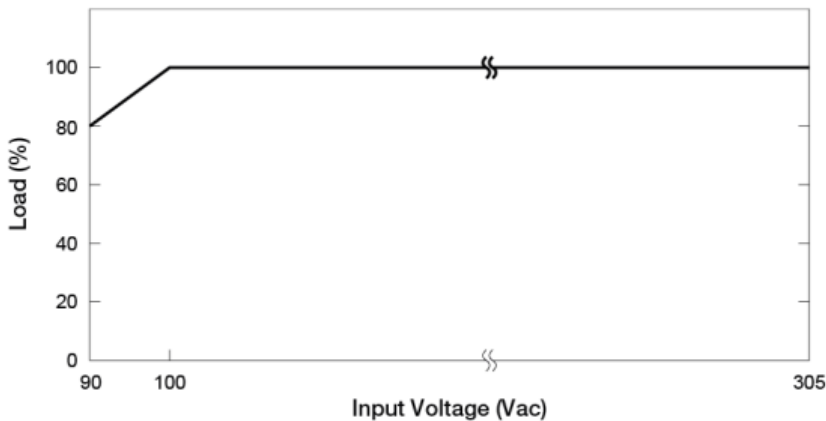

- No output power de-rating for the input voltage from:-
100Vac to 305Vac (LNE-□V320W□AA),
100Vac to 264Vac (LNE- □ V320W □ CA)

■ L Frame / Enclosed

Fig. 2 De-rating for Low Input Voltage (All Models)

< 100Vac de-rate power by 2% / Vac

LED Driver

LNE-320W Series / LNE-□V320W□□A

Output Load VS LED Driver Case Temperature

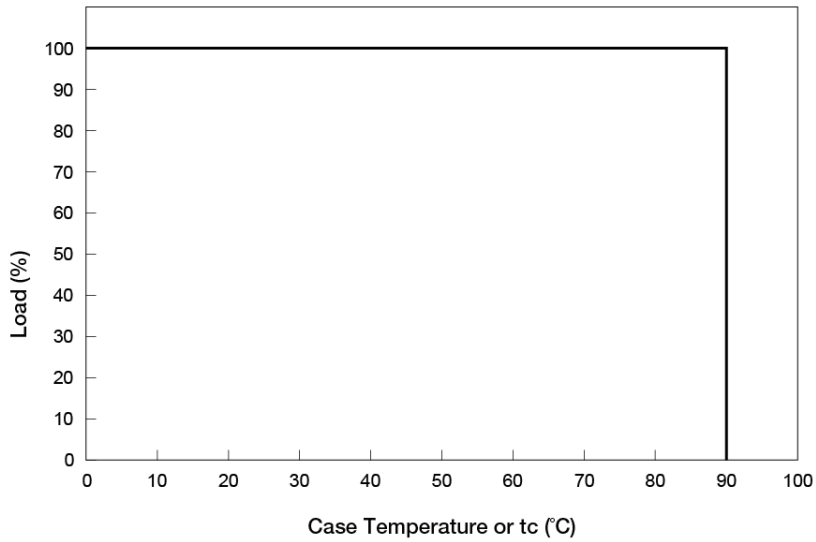

- The LED Driver can support 100% rated load for case hot spot surface temperatures of less than 90°C.

LED Driver

LNE-320W Series / LNE-□V320W□□A

Assembly & Installation

Mounting holes for LED driver assembly onto the mounting surface.

<p>Ⓐ, Ⓑ</p>	<p>Mounting holes for the LED driver (device). There are 3 mounting holes at either end of the device (locations Ⓐ and Ⓑ in Fig. 3). The device shall be mounted using a minimum of 2 out of the 3 mounting holes on both sides. Mounting shall be done using M4 screws with minimum length of 5mm. If customer's end system or panel where the device is mounted does not have screw threads, please use suitable metal screw and nut to secure the device.</p>
<p>Ⓒ</p>	<p>Surface Ⓒ belongs to customer's end product or panel where the device is mounted. The device should be mounted on a sturdy heat conducting surface with minimum of 4 mounting holes, as detailed above.</p>



Fig. 3 Mounting Hole Locations

Safety Instructions

- ALWAYS switch mains of input power OFF before connecting and disconnecting the input voltage to the device. If mains are not turned OFF, there is risk of explosion / severe damage.
- To guarantee sufficient convection cooling, keep a distance of 50mm above and lateral distance to nearby objects.
- The device is not recommended to be placed on low thermal conductive surfaces. For example, plastics.
- DO NOT insert any objects into the device.
- Note that the enclosure of the device can become very hot depending on the surrounding air temperature and output load connected to the device. Risk of burns!
- If the device is continuously operating outside the shaded region shown in Fig. 1. The device may be damaged or degraded.
- When the PE (Green/Yellow) wire of the device is not connected, the device must be installed on a metal plate that has a PE connection.
- The current rating for the all wires, connected to the input and output wires of the device, must be rated higher than or equal to the input and output current of the power supply. Please refer to the product specifications.
- For device with dimming function, always ensure the dimming control is working properly.
- Please ensure the correct tools are used for all adjustments and installations of the device. If in doubt, please consult your local Delta support or contact us via info@DeltaPSU.com.

LED Driver

LNE-320W Series / LNE-□V320W□□A

Functions

Start-up Time

The time required for the output voltage to reach 90% of its final steady state set value, after the input voltage is applied.

Rise Time

The time required for the output voltage to change from 10% to 90% of its final steady state set value.

Hold-up Time

Time between the collapse of the AC input voltage, and the output falling to 95% of its steady state set value.

■ Graph illustrating the Start-up Time, Rise Time, and Hold-up Time

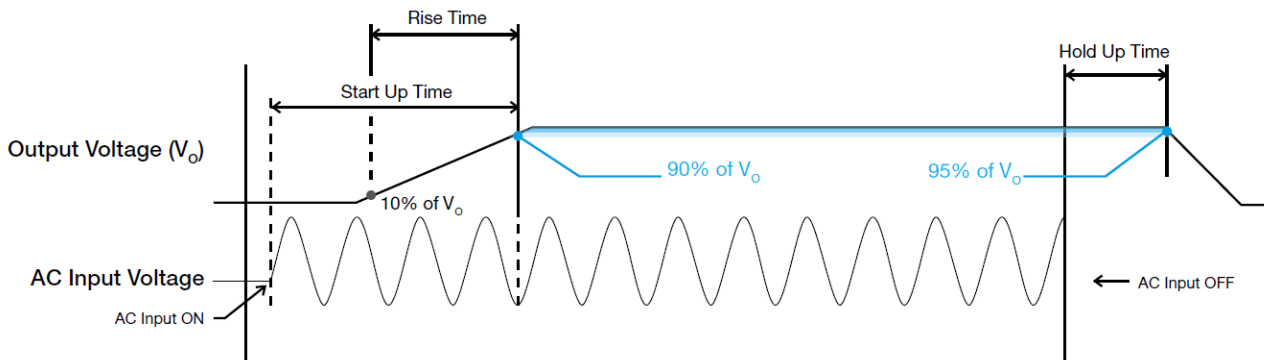

Inrush Current

Inrush current is the peak, instantaneous, input current measured and, occurs when the input voltage is first applied. For AC input voltages, the maximum peak value of inrush current will occur during the first half cycle of the applied AC voltage. This peak value decreases exponentially during subsequent cycles of AC voltage.

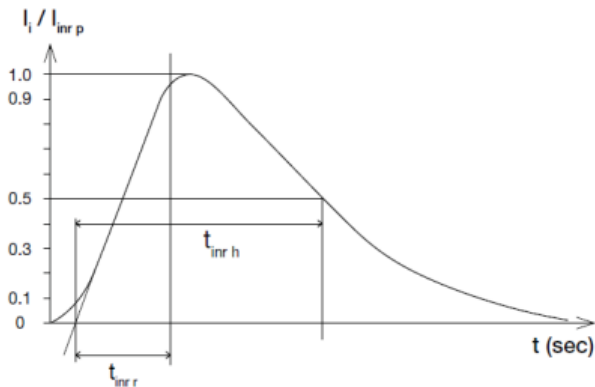

Dynamic Response (For CV Operation Only)

The power supply output voltage will remain within $\pm 5\%$ of its steady state value, when subjected to a dynamic load from 0 to 100% of its rated current.

■ 90% Duty / 1 KHz

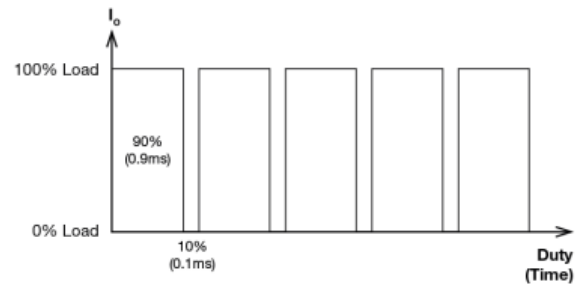

■ 90% Duty / 120 Hz

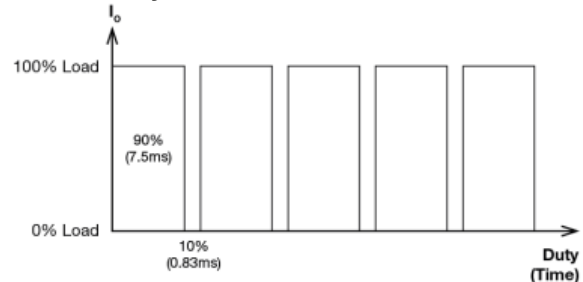

LED Driver

LNE-320W Series / LNE-□V320W□□A

Operating Methods of LED Modules-CV and CC Operation

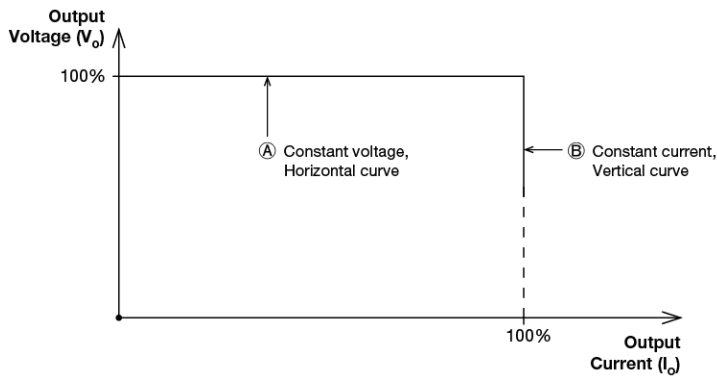

A typical LED power supply is able to either work in "constant voltage mode (CV) or constant current mode (CC)" to drive the LEDs. DELTA's LNE drivers integrate CV+CC characteristics; so operation in CV mode (with external LED driver), in region (A) or CC mode (direct drive, at area (B)).

In the constant current region, the highest voltage at the output of the driver depends on the configuration of the end systems.

Should there be any compatibility issues or other questions with these adjustment methods, please contact with Delta.

Dimming Operations

This operation is available for LNE-□V320WD□A only. The Dimming connection diagram for turning the lighting fixture ON/OFF can be configured as below.

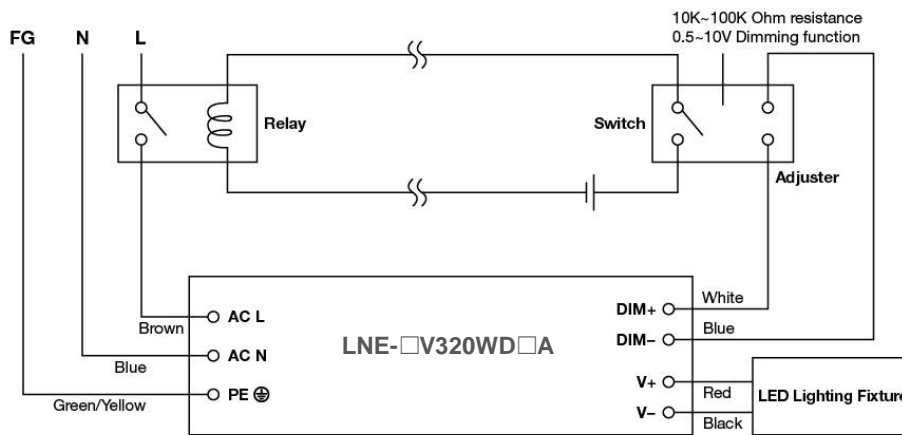

Please refer an example of reference configuration as follows.

1. Built-in 3 in 1 dimming function, IP67 rated. Output constant current level can be adjusted through output cable that has the white and blue wires, by connecting a resistance or 0.5~10Vdc or 10V PWM signal between DIM+ and DIM-.
2. Dimming source current from external power supply about 100 μ A (Typical).
3. The LED lighting fixture can be turned ON/OFF by the switch.
4. Please DO NOT connect "DIM-" to "V-".
5. Reference resistance value for output current adjustment (Typical).

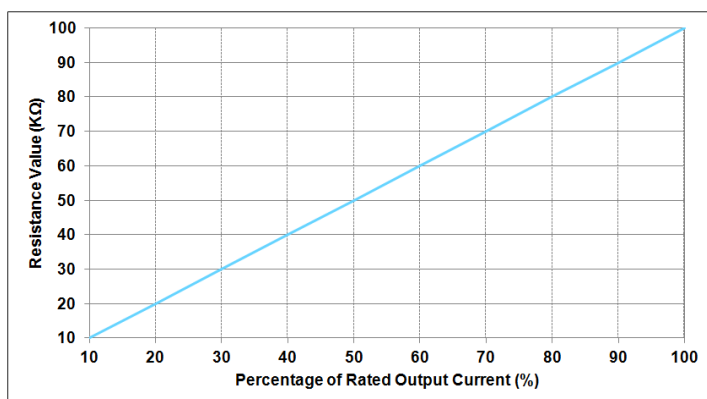

LED Driver

LNE-320W Series / LNE-□V320W□□A

6. 0.5 ~ 10V dimming function for output current adjustment (Typical).

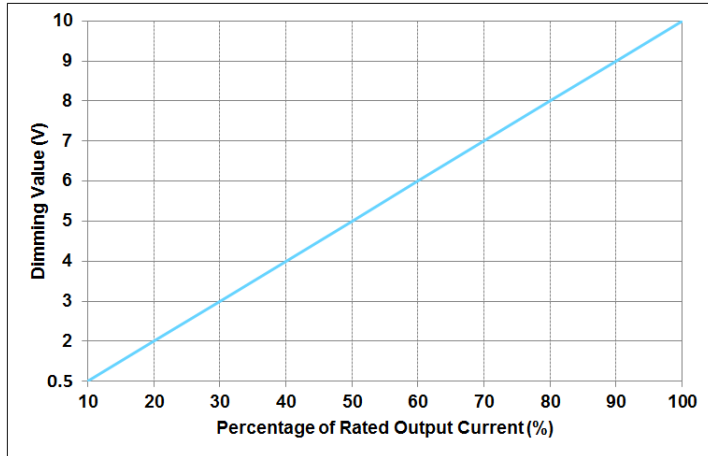

7. 10V PWM signal for output current adjustment is also possible. For additional information, please contact your Delta sales representative.
8. Please note that LNE-□V320WD□A can't turn the lighting fixture completely off (totally dark) by using any of these dimming adjustment methods. To completely turn off the lighting fixture, the input AC voltage must be removed. See illustration on previous page.

External Input Protection Device

The unit is protected at the L pin, with an internal fuse that cannot be replaced. The power supply has been tested and approved on 20A branch circuits without additional protection device. An external protection device is only required if the supplying branch has an ampacity greater than above. Thus, if an external protective device is necessary, a 20 Ampere C-characteristic circuit breaker can be utilized.

LED Driver

LNE-320W Series / LNE-□V320W□□A

Overload & Overcurrent Protections (Auto-Recovery)

The power supply's Overload (OLP) and Overcurrent (OCP) Protections will be activated when output current is between 95% and 108% of I_o (Max load). Upon such an occurrence, the V_o (output voltage) will start to droop. Once the power supply has reached its maximum power limit, the protection will be activated; and, the power supply will operate in "CC mode". The power supply will recover once the fault condition once the cause of OLP or OCP is removed, and I_o (output current) is back within the specified range.

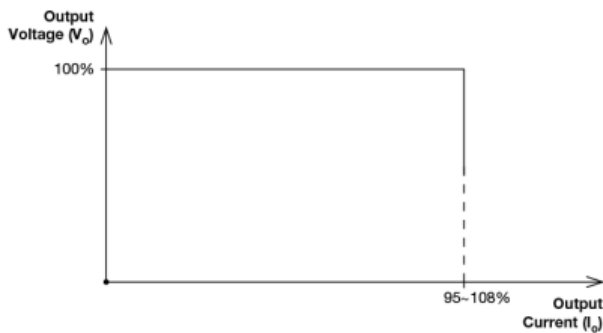

Short Circuit Protection (Auto-Recovery)

The power supply's output OLP/OCP function also provides protection against short circuits. When a short circuit is applied, the power supply will operate in "CC mode", as shown in the illustration in the OLP/OCP section on this page. The power supply will return to normal operation after the short circuit is removed.

Overvoltage Protection (Latch Mode)

The power supply's overvoltage circuit will be activated when its internal feedback circuit fails. The output voltage shall not exceed its specifications as described in "Protections" section. Power supply will latch, and require removal/re-application of input AC voltage in order to restart.

The power supply should be latch.

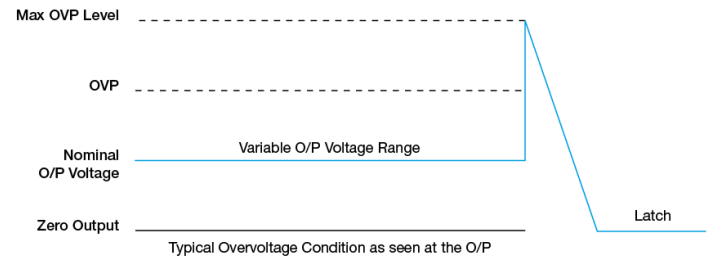

Over Temperature Protection (Auto-Recovery)

As described in load de-rating section, the power supply also has Over Temperature Protection (OTP). In the event of a higher operating temperature at 100% load, the power supply will run into OTP when the operating temperature is beyond what is recommended in the de-rating graph. When activated, the output voltage will go into bouncing mode until the temperature drops to its normal operating temperature as recommended in the de-rating graph.

Others

Delta RoHS Compliant



Restriction of the usage of hazardous substances

The European directive 2011/65/EU limits the maximum impurity level of homogeneous materials such as lead, mercury, cadmium, chrome, polybrominated flame retardants PBB and PBDE for the use in electrical and electronic equipment. RoHS is the abbreviation for "Restriction of the use of certain hazardous substances in electrical and electronic equipment".

This product conforms to this standard.

PFC – Norm EN 61000-3-2

Line Current Harmonic content

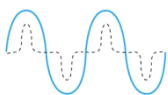

Typically, the input current waveform is not sinusoidal due to the periodical peak charging of the input capacitor. In industrial environment, complying with EN 61000-3-2 is only necessary under special conditions. Complying to this standard can have some technical drawbacks, such as lower efficiency as well as some commercial aspects such as higher purchasing costs. Frequently, the user does not profit from fulfilling this standard, therefore, it is important to know whether it is mandatory to meet this standard for a specific application.

Attention

Delta provides all information in the datasheets on an "AS IS" basis and does not offer any kind of warranty through the information for using the product. In the event of any discrepancy between the information in the catalog and datasheets, the datasheets shall prevail (please refer to www.DeltaPSU.com for the latest datasheets information). Delta shall have no liability of indemnification for any claim or action arising from any error for the provided information in the datasheets. Customer shall take its responsibility for evaluation of using the product before placing an order with Delta.

Delta reserves the right to make changes to the information described in the datasheets without notice.



Mouser Electronics

Authorized Distributor

Click to View Pricing, Inventory, Delivery & Lifecycle Information:

Delta Electronics:

[LNE-12V320WAAA](#) [LNE-36V320WAAA](#) [LNE-48V320WAAA](#) [LNE-24V320WAAA](#) [LNE-48V320WDCA](#) [LNE-48V320WBAA](#) [LNE-36V320WDAA](#) [LNE-24V320WDAA](#) [LNE-24V320WDCA](#) [LNE-48V320WBCA](#) [LNE-12V320WBCA](#) [LNE-36V320WBCA](#) [LNE-24V320WACA](#) [LNE-24V320WBCA](#) [LNE-48V320WDAA](#) [LNE-36V320WBAA](#) [LNE-24V320WBAA](#) [LNE-12V320WBAA](#) [LNE-12V320WDCA](#) [LNE-12V320WACA](#) [LNE-36V320WDCA](#) [LNE-12V320WDAA](#) [LNE-36V320WACA](#) [LNE-48V320WACA](#)