

# LED Driver

## EUCO ARENA SPORT 600 W Series

# EUCO ARENA SPORT

### Highlights & Features

- Output power: max 600 W
- Wide input voltage: 198-440 Vac
- Ultra high Efficiency 97.5%
- Control method: DALI-2 & D4i and RDM/DMX
- Programmable output current range 700-2000 mA
- Constant Lumen Output (CLO)
- Smart Timer Dimming (STD)
- Wide dimming range 0.1-100%
- High-accuracy integrated power metering
- Input surge protection: DM 6kV; CM 10kV
- Max remote distance 300 meters
- Reliable IP66 input/output connectors
- Low current ripple (typ.1%) for HDTV broadcasting
- Afterglow effect free



### Standards & Marks



**Model Number:** EUCO-600200G□□□

**Unit Weight:** ~2.2 kg

**Dimensions (L x W x H):** 285 x 100 x 49 mm

### General Description

Delta EUCO ARENA SPORT 600W series with DALI-2 & D4i or RDM/DMX control functions are constant current non-isolated LED drivers. It makes an ideal solution for Stadium Lighting due to its low ripple current level and flicker free, which is indispensable for Live TV broadcasting conditions. Also due to its robust design, the EUCO-600W is well-suited for industrial lighting, high mast lighting, and horticulture applications. This driver was specifically conceived and intended to offer remarkably high efficiency to achieve substantial energy savings. Additionally, a wide dimming range, advanced control, and autonomous dimming (Midnight Centric Timer) ensure adaptability for dynamic atmospheres and seamless event adjustments. The EUCO-600W driver offers a remote-control function, allowing the driver to be installed up to 300 meters from the luminaire, which provides greater flexibility in installation, operation, and easy maintenance for indoor and outdoor applications.

### Model Information

Model Number	Input Voltage Range	Rated Output Power	Output Channel	Control Interface
EUCO-600200GI□□□□	220/400 Vac (typical) 198~440 Vac (range)	600 W	1	DALI-2 & D4i
EUCO-600200GD□□□□		600 W	1	RDM / DMX

### Model Numbering

EU	C	O	600	□□□	G	□	□	□□
Market Code	Constant Current	Outdoor	Output power 600:600 W	Output Current 200:2000 mA (Max.)	i-Programming	Function I: DALI-2 & D4i D: RDM / DMX	Variable A – connector (with NTC) C – connector (with PE) D – cable (with PE)	Mode series, can be 0-9, A-Z or blank.

# LED Driver

## EUCO ARENA SPORT 600 W Series

### Specifications

#### Input Ratings / Characteristics

Specification	Min.	Typ.	Max.	Conditions
Nominal Input Voltage	220Vac	-	400Vac	
Input Voltage Range	198Vac	-	440Vac	
Nominal Input Frequency	-	50/60Hz	-	
Input Frequency Range	47Hz	-	63Hz	
Nominal Input Current	-	2.85A	3.1A	At 220Vac, 25°C, 600W output
	-	1.54A	1.82A	At 400Vac, 25°C, 600W output
Efficiency <sup>1</sup>	-	96.2%	-	At 220Vac, 25°C, 300V/2A
	-	96.6%	-	At 220Vac, 25°C, 550V/1.1A
	-	96.8%	-	At 400Vac, 25°C, 300V/2A output
	-	97.5%	-	At 400Vac, 25°C, 550V/1.1A output
Standby Power Consumption	-	0.40W	-	At 230Vac/50Hz, Dim OFF, in compliance with Erp (EU) 2019/2020
	-	0.89W	-	At 400Vac, Dim OFF
Power Factor	-	0.99	-	At 220Vac, 25°C, 600W output
	-	0.98	-	At 400Vac, 25°C, 600W output
Total Harmonic Distortion	-	8%	-	At 220Vac, 25°C, 300V/2A output
	-	13%	-	At 400Vac, 25°C, 300V/2A output
Inrush Current (Apk / 50%-us)	-	8A	-	At 220Vac, 50%Apk to 50%Apk time: 2ms
	-	15A	-	At 400Vac, 50%Apk to 50%Apk time: 2ms
Power metering accuracy	-	±1%	±2%	At 220Vac~400Vac, 100% load

1. 100% Load and tested after 30 minutes warming up.

#### Output Ratings / Characteristics

Specification	Min.	Typ.	Max.	Conditions	
Output Channels	-	1	-		
Default Output Current	-	1200mA	-		
Programmable Output Current Range	700mA	-	2000mA	Operation range refer to Appendix 1	
Output Voltage Range	200V	-	550V		
Max. No Load Output Voltage	-	-	600Vrms		
Total Output Power	-	-	600W		
Output Power Range	-	-	600W		
Output Current Tolerance	-	-	±3%	700~2000mA	
Output Current Ripple	-	1%	2%	(ripple = (pk-pk)/avg), at low frequency(<8kHz)	
	-	10%	18%	(ripple = (pk-pk)/avg), at high frequency(>15kHz)	
Output Remote Distance	-	-	300m	The total voltage drop on the cable should be within 5V	
Turn on Delay Time	DALI version	-	0.7s	1s	Compliant with clause 9.13 of IEC 62386-102:2014
	RDM/DMX version	-	0.7s	1s	Connecting to the controller correctly.
		1.25s	-	-	No controller or incorrect connection to the controller, compliant with clause 3.5 of ANSI E1.37-1:2012.

# LED Driver

## EUCO ARENA SPORT 600 W Series

### Dimming Control

Specification		EUCO-600200GI□□□	EUCO-600200GD□□□
Control interface		DALI-2	RDM/DMX
Dimming range	Logarithmic	0.1%-100% Minimum output current is limited to 2mA.	N/A
	Linear	0.4%-100% Minimum output current is limited to 2mA	

### Control Interface Standards

Specification	EUCO-600200GI□□□	EUCO-600200GD□□□
Control interface standards	DALI-2 & D4i IEC 62386-101 Ed 2.0 IEC 62386-102 Ed 2.0 IEC 62386-207 Ed 2.0 IEC 62386 part 150: Integrated 24Vdc auxiliary power supply IEC 62386 part 250: Integrated bus power supply <sup>3</sup> IEC 62386 part 251: Memory bank 1 extension (luminaire data) IEC 62386 part 252: Energy report IEC 62386 part 253: Diagnostics and maintenance	RDM/DMX ANSI E1.11 DMX512A ANSI E1.20 RDM – Remote Device Management ANSI E1.37-1 Additional message sets for dimmer

### Additional Dimming Features:

Specification	EUCO-600200G□□□□
Smart Timer Dimming (STD)	3 different configurable dimming profiles over the night are available for users to select and set in GUI. Details refer to <b>LNA/EUCO Series Programming Tool User Manual</b> .
Constant Lumen Output (CLO)	CLO function is to compensate the ageing of the light source, and so to get constant Lumen Output over the lifetime of the product. It's available in GUI to set starting dimming level (for example 90%) and end of life of the product (for example 50,000hrs), so that the driver by counting its functioning hours can do a linear interpolation in between starting dimming level at t=0hrs, and go to 100% at t=end of life. Details refer to <b>LNA/EUCO Series Programming Tool User Manual</b> .

# LED Driver

## EUCO ARENA SPORT 600 W Series

### Mechanical Characteristics

Specification	EUCO-600200G□□□□	
Casing	Aluminum case, Color : anodized(Nature)	
Dimensions (L x W x H)	285x100x49 mm	
Unit Weight	~2.2 kg	
Cooling System	Natural Convection	
<b>CONNECTION</b>	<b>EUCO-600200GIA□□</b>	<b>EUCO-600200GDA□□</b>
INPUT	Wieland RST 2013F S2 M01VH GN0, with the definition of L1, L2, PE	
OUTPUT	Amphenol CC-03PMFS-QC801P, with the definition of NTC, V+, V-	
DIMMING	Amphenol AD-03PMMS-QC8001 DA+, DA-, +24V	Amphenol AD-03PMMS-QC8001 D1+, D1-, COM
<b>CONNECTION</b>	<b>EUCO-600200GIC□□</b>	<b>EUCO-600200GDC□□</b>
INPUT	Wieland RST 2013F S2 M01VH GN0, with the definition of L1, L2, PE	
OUTPUT	Amphenol CC-03PMFS-QC801P, with the definition of PE, V+, V-	
DIMMING	Amphenol AD-03PMMS-QC8001 DA+, DA-, +24V	Amphenol AD-03PMMS-QC8001 D1+, D1-, COM
<b>CONNECTION</b>	<b>EUCO-600200GID□□</b>	<b>EUCO-600200GDD□□</b>
Input Cable	Line(L): Brown, Neutral(N): Blue, PE: Yellow & Green, SOOW & H07RN-F & 2PNCT, 3C/1.0 mm <sup>2</sup> (17AWG), Length: 300mm±25mm	
Output Cable	Positive(V+): Brown, Negative(V-): Blue, PE: Yellow & Green, SOOW & H07RN-F & 2PNCT, 3C/1.0 mm <sup>2</sup> (17AWG), Length: 240mm±25mm	
Control Cable	Positive(DA+): Purple, Negative(DA-): Pink, +24V: Black & White, PLTC, 22 AWG, Length: 300mm±25mm	Positive(D1+): Purple, Negative(D1-): Pink, COM: Black & White, PLTC, 22 AWG, Length: 300mm±25mm

# LED Driver

## EUCO ARENA SPORT 600 W Series

### Environment & Package

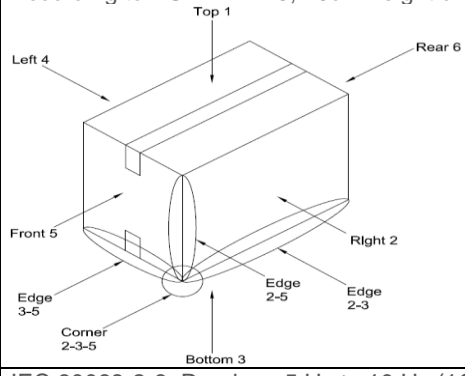
Specification		EUCO-600200GI□□□	EUCO-600200GD□□□
Ambient Temperature	Operating	-40 ~+60°C	
	Storage	-40°C to +85°C	
Maximum Case Temperature		+85°C	
Lifetime Case Temperature		+70°C	
Relative Humidity	Operating	10% to 90% RH (Non-Condensing)	
	Storage	10% to 90% RH (Non-Condensing)	
Audible Noise (30cm distance)		Sound Pressure Level (SPL) < 24dBA	
Ingress Protection classification		IP66	
Drop Test (Non-Operating)		<p>According to ASTM D-775, 40cm height drop to concrete floor as below drawing, total 10 times.</p> 	
Vibration (Non-Operating)		IEC 60068-2-6, Random: 5 Hz to 10 Hz (1G); 30 min per axis for all X, Y, Z direction	
Packing		4pcs per carton	

# LED Driver

## EUCO ARENA SPORT 600 W Series

### Protections

Specification		Min.	Typ.	Max.	Notes
Input Under Voltage Protection(IUVP)	Protection	160Vac	-	180Vac	The driver shuts down and then restarts to normal status when the fault condition is cleared.
	Recovery	170Vac	-	190Vac	
Input Over Voltage Protection(IOVP)	Protection	460Vac	-	480Vac	
	Recovery	440Vac	-	460Vac	
Open Load & Output Over Voltage Protection	Protection	-	-	600Vrms	Hiccup mode. The output voltage shall not exceed 600Vrms under no load, open load or other over voltage conditions.
Constant Output Power Protection		-	610W	-	Output power limited. The driver shall come back to its original programmed current after the fault condition is cleared.
Output Short Circuit Protection		-	-	-	Hiccup mode
Internal Over Temperature Protection		85°C	-	95°C	Output power derating. Refer to <a href="#">Appendix 6 "Internal Over Temperature Protection"</a> for more details.
Programmable External Over Temperature Protection		80°C	-	110°C	Output power derating. Refer to <a href="#">Appendix 7 "Programmable External Over Temperature Protection"</a> for more details.

### Electro-Magnetic Compatibility (EMC)

Specification	Standards
<b>EMC-Emission Characteristics</b>	
Radiated Emission	EN55015, GB/T17743
Conducted Emission	EN55015, GB/T17743
Harmonic Current Emission	EN61000-3-2, GB 17625.1
Voltage Fluctuation & Flicker	EN61000-3-3
<b>EMC-Immunity Characteristics</b>	
Electrostatic Discharge(ESD)	EN 61000-4-2
Radio Frequency Electro-magnetic Fields	EN 61000-4-3
Electrical Fast Transient (EFT)	EN 61000-4-4
Surge(AC Mains)	EN 61000-4-5 - Common Mode: 10kV <sup>2</sup> (Line to Earth, Neutral to Earth) - Differential Mode: 6kV (Line to Neutral)
Conducted Disturbance	EN61000-4-6
Voltage Dip & Interruptions	EN 61000-4-11

2. Level B, the peak of residual common mode voltage pulse from output +/- to Earth is typically around 2.5kV.

### Reliability Data

Specification	Test Conditions / Notes
Lifetime	50,000 hours applicable for 220Vac to 400Vac(50/60Hz) @100% of load, @ Ta 45°C Refer to "Lifetime versus Case Temperature Curve"
MTBF	475khrs at Ta=+45°C Telcordia SR-332

# LED Driver

## EUCO ARENA SPORT 600 W Series

### Safety Agencies Approvals

Specification		Test Conditions / Notes
ENEC	MARK	EN 61347-2-13:2014, EN 61347-2-13/A1:2017 EN 61347-1:2015, EN 61347-1:2015/A1:2021 EN IEC 62384:2020
CE	MARK	CE Declaration of Conformity.
CB	REPORT	EN 61347-1:2015, EN 61347-1:2015/A1:2021 EN 61347-2-13:2014, EN 61347-2-13/A1:2017
UKCA	MARK	BS EN 61347-2-13: 2014+A1:2017
RCM	MARK	AS 61347-2-13: 2018 AS/NZS 61347-1: 2016+A1
Isolation		Class I, input to output: non-isolation, RDM/DMX or DALI to input/output: reinforced isolation.
RoHS		RoHS 2.0 Directive(EU) 2015/863
REACH		In compliance

### Drivers for Each Circuit Breaker

The maximum number of LED drivers connectable to a single MCB is recommended in the following table for maximum 600W and each nominal input voltage. Due to the different kinds of circuit breakers available on the market, this table is just for reference.

Input Voltage	MCB Type	10A	16A	20A	25A	32A	40A	63A
220Vac	B	2	4	5	6	8	10	15
	C							
400Vac	B	2	3	3	4	5	7	11
	C	3	5	6	7	9	11	18

### Electrical Connection

1. A version (Output with NTC)

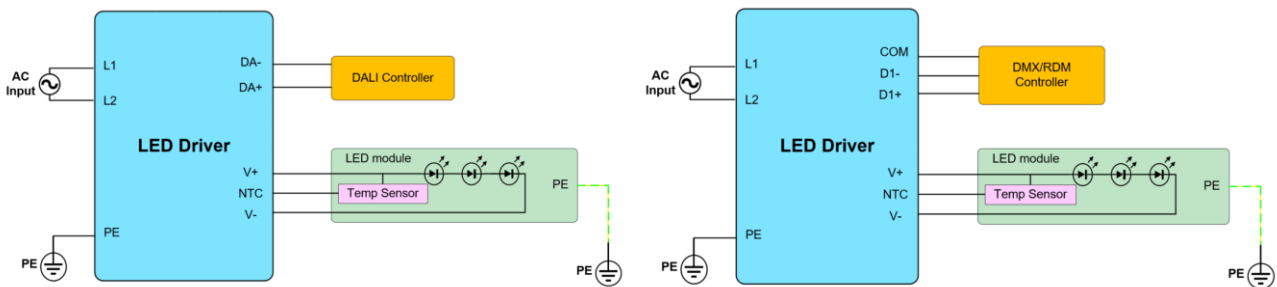

Note: There's no PE port in driver output for the luminaire connection, instead, the mounting hole of driver chassis could be connected for this function.

# LED Driver

## EUCO ARENA SPORT 600 W Series

### 2. C and D version (Output with PE)

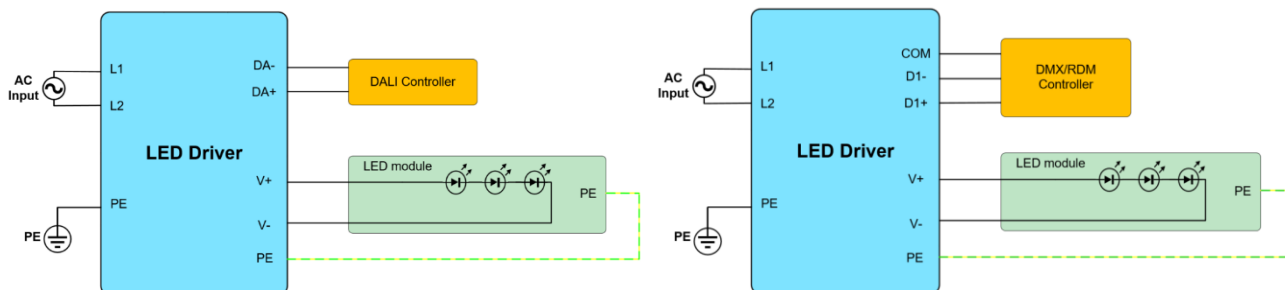

### Programming Configuration

Common setting functions and implementation methods/conditions are shown in the following table, more functions and details please refer to the **LNA/EUCO Series Programming Tool User Manual**.

Item		DALI	DMX
Setup	Tool Connection	DA+,DA-	D1+,D1-
	AC power supply	■	■
	Load Connection	○	○
Tool	Delta Programming Tool	SDDV1505UAC (SDDV1505UAB, SDPTDV05UAB)	
Configurable Parameters and Functions	Max. current programming	√	√
	Default output current	√	√
	Luminaire OTP setting	√	√
	Constant lumen output setting	√	√
	Smart timer dimming	√	√
	Software update	√	√

Note: ■ Required, ○ Optional, √ Available.



# LED Driver

## EUCO ARENA SPORT 600 W Series

### Physical Dimensions

1. A and C version

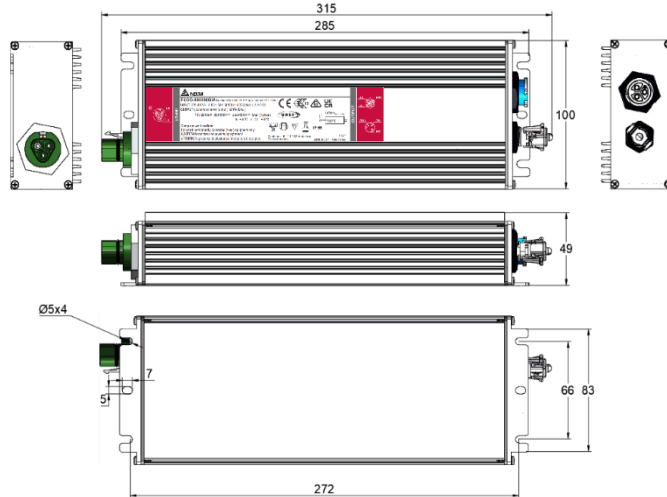

Unit: mm

AC CONNECTOR  
WIELAND  
RST 20i3F S2 M01VH GN0

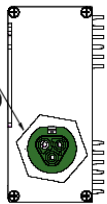

DC CONNECTOR  
AMPHENOL  
CC-03PMFS-QC801P

DIMMING CONNECTOR  
AMPHENOL  
AD-03PMMS-QC8001

a) Connect to the AC Input

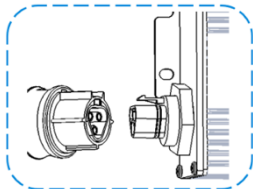

Align key features of input connector on driver with connector on luminaire power cord.

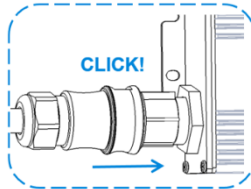

Push connectors together until a click is heard.

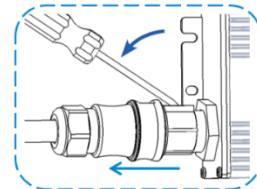

To disassemble connectors, insert and twist a small blade screwdriver and then separate connectors.

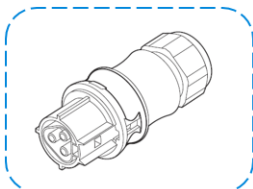

custom AC input connection, use a Wieland RST20i3 green connector (96.031.4055.7 OR 96.031.0055.7)

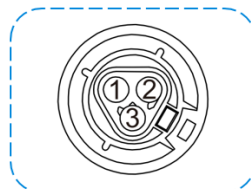

Connector pin-out

Pin	AC Input Connector
1	L1
2	L2
3	PE

Pin Arrangement

# LED Driver

## EUCO ARENA SPORT 600 W Series

b) Connect to the LED Output

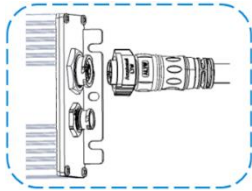

Align key features of larger output connector on driver with connector on luminaire cable.

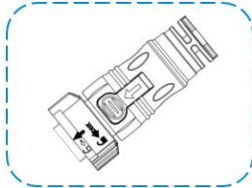

Custom DC output connection, use a Amphenol X-lok C size connector (CC-03AFMM-QL8EXX(Overmolded with cable) OR CC-03BFMB-QL8APA(Field installable))

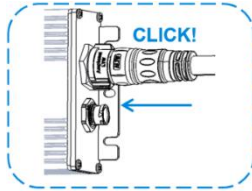

Push connectors together until the lock ring has snapped into place and a click is heard.

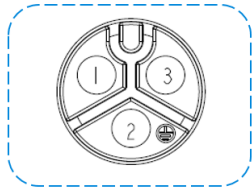

Connector pin-out

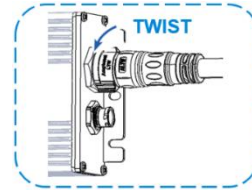

To disassemble connectors, twist the lock ring and then separate connectors.

Pin	A version	C version
1	V+	V+
2	NTC	PE
3	V-	V-

Pin Arrangement

c) Connect to the Control/Dimming Output

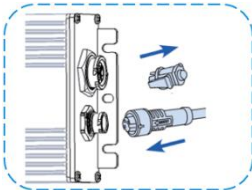

Remove cap, align key features of Dimming connector on driver with connector on luminaire cable

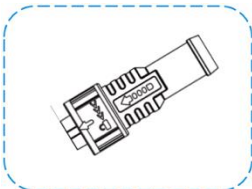

Custom Dimming connection, use a Amphenol X-lok A size connector (AD-03BFFM-QL8DXX(Overmolded with cable) OR AD-03BFFB-QL8AP0(Field installable))

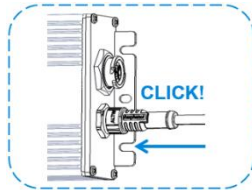

Push connectors together until the lock ring has snapped into place and a click is heard.

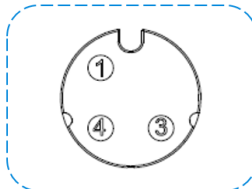

Connector pin-out

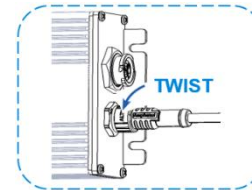

To disassemble connectors, twist the lock ring and then separate connectors.

Pin	Dimming Connector	
1	DA+	D1+
3	+24V	COM
4	DA-	D1-

Pin Arrangement

Please note that Amphenol matching connector has two types as below. One is type A over molded with cable, which is suitable for the length of the cable is fixed, and the part number is CC-03AFMM-QL8EXX and AD-03BFFM-QL8DXX ("XX" the length of cable). The other is type B connector and cable are separated, it will be best option for field installation, the part number is CC-03BFMB-QL8APA and AD-03BFFB-QL8AP0.

Receptacle to Overmolded with Cable

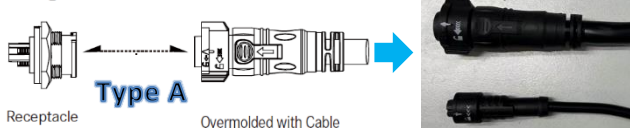

Receptacle to Field Installable

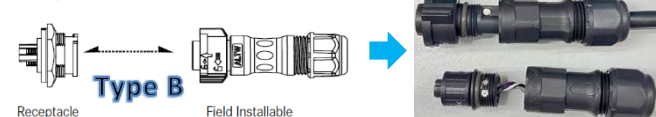

# LED Driver

## EUCO ARENA SPORT 600 W Series

### 2. D version

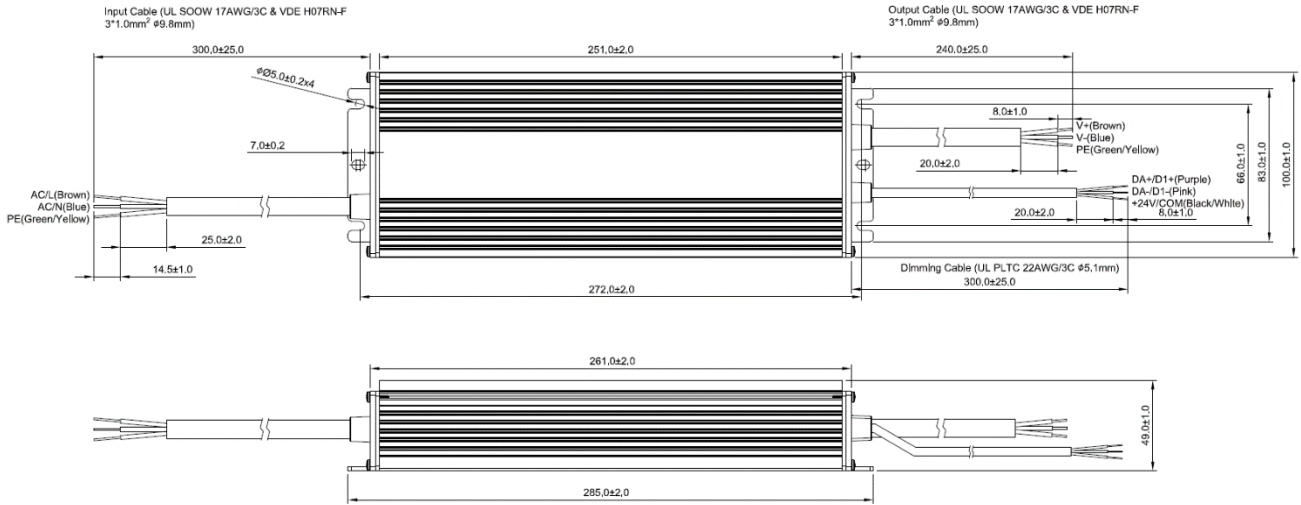

Unit: mm

	Wire Color	Function	Cable Length	Strip Length	Sheath Length
Input Cable	Brown	L	300.0±25.0 mm	14.5±1.0 mm	25.0±2.0 mm
	Blue	N			
	Green/Yellow	PE			
Output Cable	Brown	V+	240.0±25.0 mm	8.0±1.0 mm	20.0±2.0 mm
	Blue	V-			
	Green/Yellow	PE			
Dimming Cable	Purple	DA+/D1+	300.0±25.0 mm	8.0±1.0 mm	20.0±2.0 mm
	Pink	DA-/D1-			
	Black/White	+24V/COM			

# LED Driver

## EUCO ARENA SPORT 600 W Series

### Appendix

#### 1. Operating Range Curve: constant power range 1090~2000mA (Full power output)

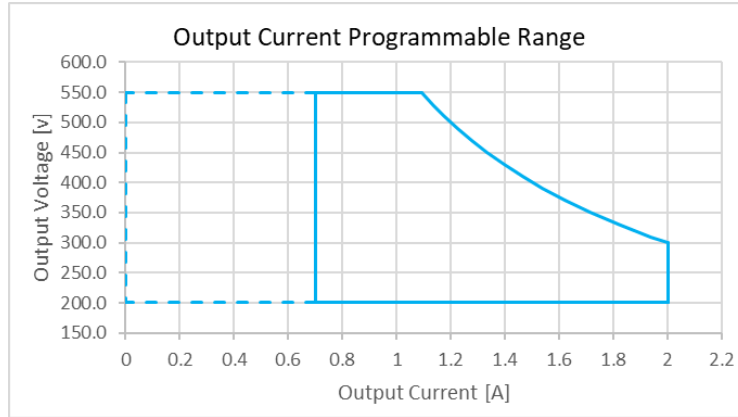

**Note:** EUCO ARENA SPORT 600W series can be programmed with wide output current through computer and programming tool. For more details, please refer to DALI programming User Manual or RDM/DMX programming User Manual.

#### 2. Life Time versus Case Temperature Curve

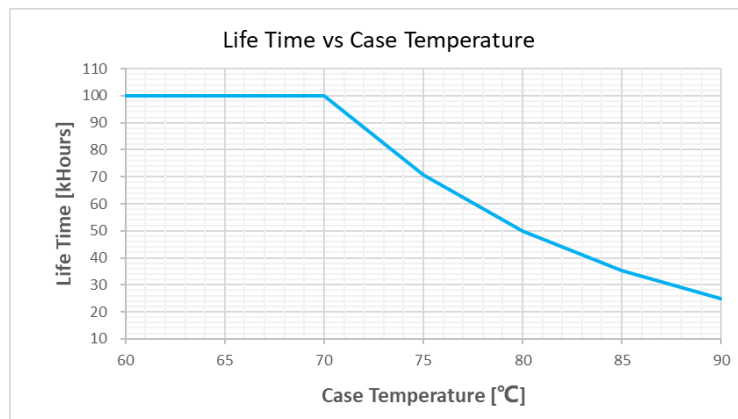

#### 3. Efficiency versus Load

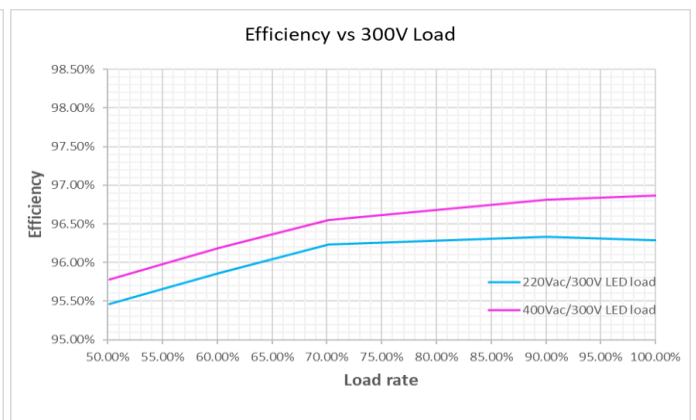
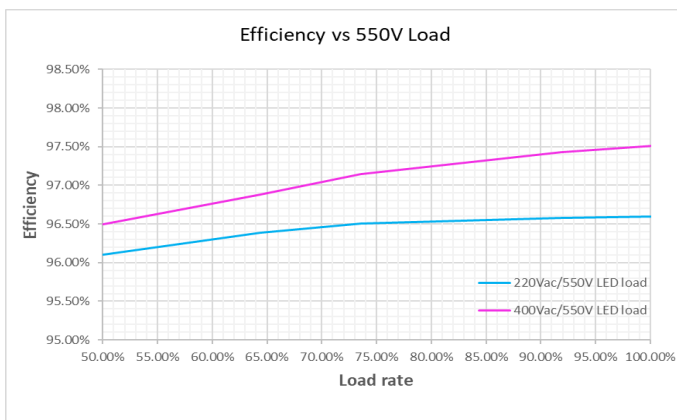

# LED Driver

## EUCO ARENA SPORT 600 W Series

### 4. Power Factor versus Load

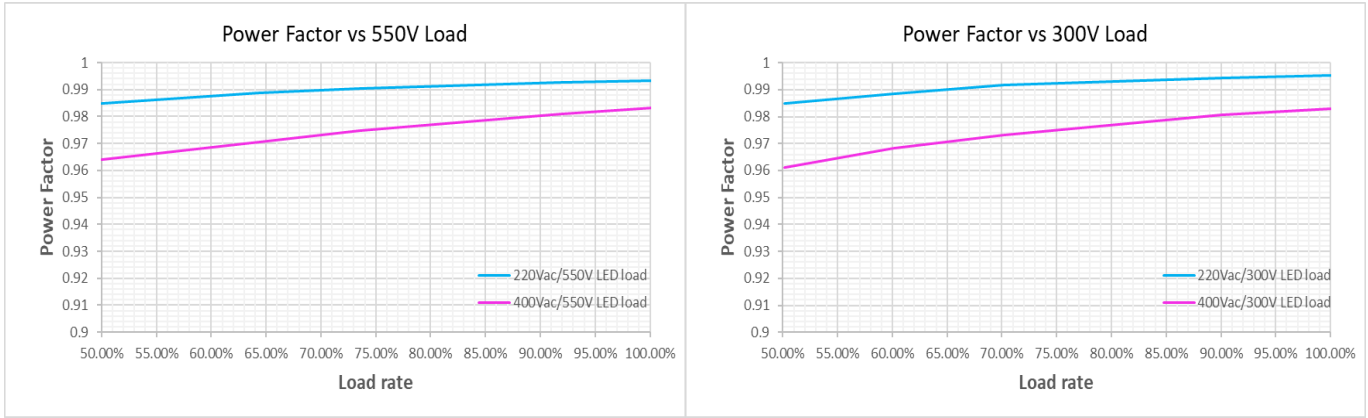

### 5. THD versus Load

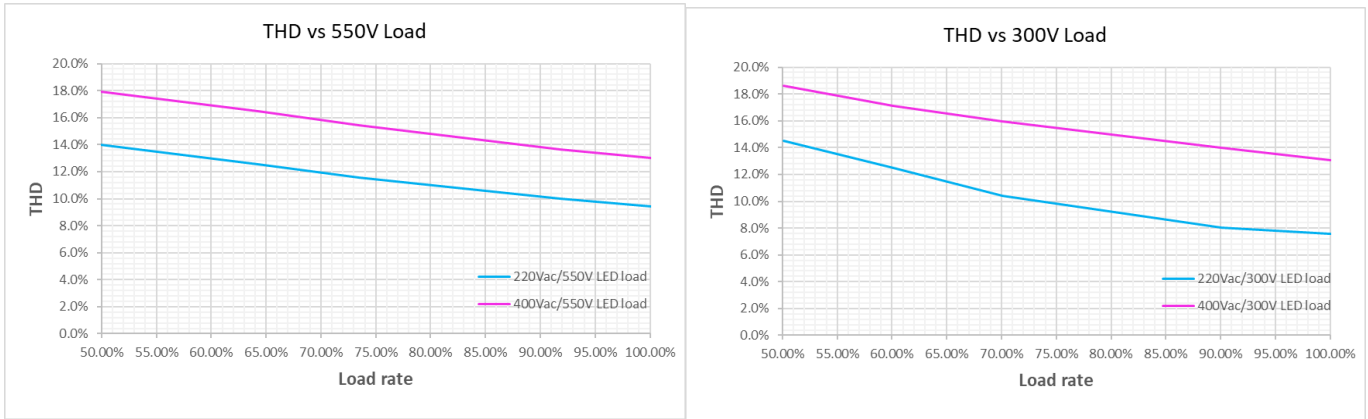

### 6. Internal Over Temperature Protection

This function ensures that the driver works under safe operating temperature condition. When the ambient temperature exceeds a fixed threshold ( $T_{c1} = 90^{\circ}\text{C}$  typical), the output current will decrease to 20% automatically to reduce the internal temperature of the driver. The minimum output current ratio is 20% of the value before the internal OTP enabled. The output current will recover to 100% when the internal temperature is below recovery threshold ( $T_{c2} = 80^{\circ}\text{C}$  typical).

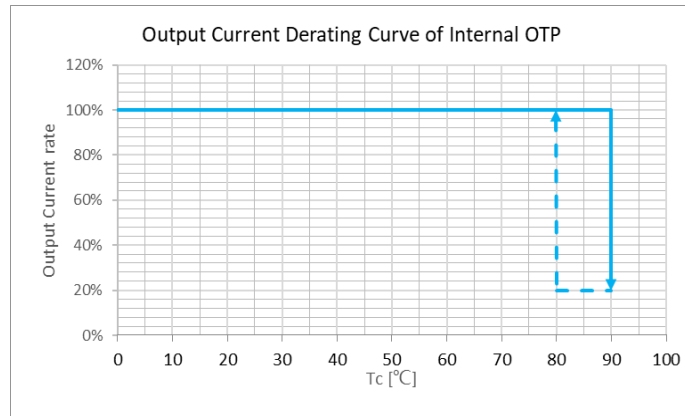

# LED Driver

## EUCO ARENA SPORT 600 W Series

### 7. Programmable External Over Temperature Protection

This protection is only available in version A and is an optional feature and user can ignore it without connecting to NTC connector in the junction box. The driver monitors the temperature of the LED module through NTC terminal. The output current will be reduced smoothly and linearly at OTP status and return to normal when the fault condition is removed.

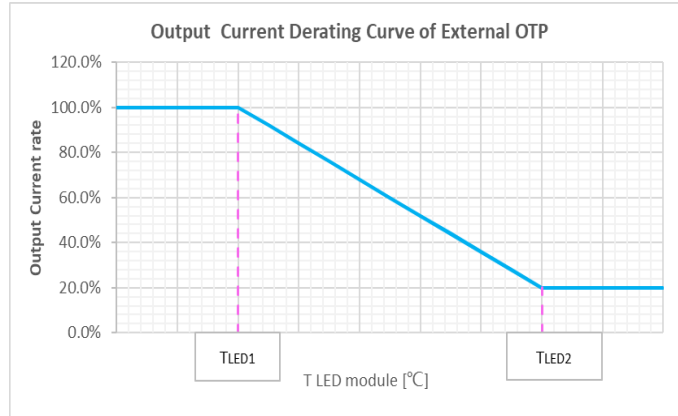

The trigger point of this protection can be set easily according to the actual conditions of the LED fixtures, the user can set the trigger point between 80 °C and 110 °C by the Delta programming tool, and the default value is 100 °C. When the temperature exceeds the triggering point, the output current will decrease automatically to bring the temperature of the LED module back to safe value. More details about parameter setting please refer to DALI programming User Manual or RDM/DMX programming User Manual.

An external temperature sensing circuit is required to achieve the NTC terminal function to prevent the LED fixture from overheating.

The default setting is for a 33Kohm NTC, the circuits shown as both (a) and (b) below are acceptable.

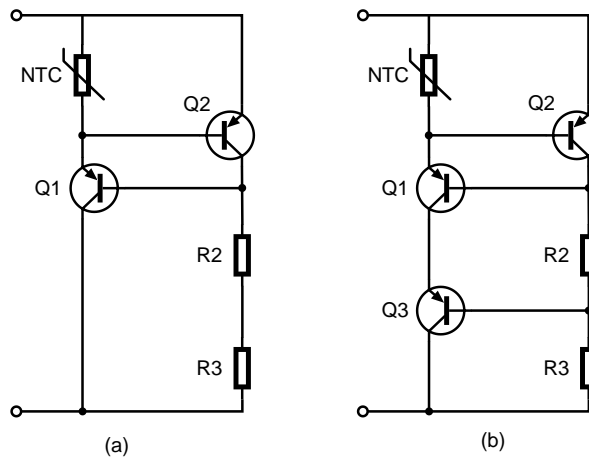

Parameter	Part	Manufacturer	Description
NTC	TSM1A333F3952RZA	THINKING	RES NTC 33Kohm F 3950K +/-1% SMD 0603 TP
R2/R3	RC1206FR-07 5M1L	YAGEO	RES SMD 1/4W 5.1Mohm F 1206
Q1/Q2/Q3	PBHV9050T	NEXPERIA	-500V -250 mA PNP high-voltage low VCEsat transistor

**Note:** The circuits of above (a) and (b) have same OTP performance by using the same parts listed in the table, and to achieve good accuracy of OTP, Q2 should be placed close to NTC to make them have same temperature.

# LED Driver

## EUCO ARENA SPORT 600 W Series

This product is also compatible with the circuitry for a 10Kohm NTC, this version could be selected and activated by “OTP on Fixture” section of GUI(Select “10K” in this section). The circuit and BOM table are shown as below.

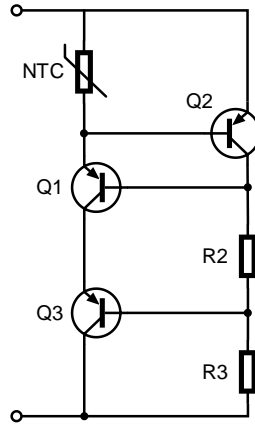

Parameter	Part	Manufacturer	Description
NTC	B57371V2103H060	TDK	RES NTC 10Kohm F 4480K +/-3% SMD 0603 TP
R2/R3	RC1206FR-07 1ML	YAGEO	RES SMD 1/4W 1Mohm F 1206
Q1/Q2	PBHV9050T	NEXPERIA	500V 150 mA PNP high-voltage low VCEsat transistor

**Note:** The output voltage need to be over 300V to be effective by using this 10Kohm NTC version. And to achieve good accuracy of OTP, Q2 should be placed close to NTC to make them have same temperature.

### 8. External SPD requirement for extra LED fixture common mode surge protection

The EUCO series driver has been designed with a built-in surge absorber which protects against lightning up to CM/DM 10kV level. The built-in surge absorber activates once a common mode surge intrusion occurring, which offers a protection against any unexpected voltage surge to the LED module of  $\leq 3kV$ .

Even though, EUCO Arena driver series do not require the installation of an additional SPD protect the driver and LED module against any unexpected surge voltage, it would allow to further strength the robustness protection capability against surge residual voltage of LED modules which allows the fixtures to be marketed globally by attributing different surge protector device (SPD) to meet differing surge levels.

However, Delta Electronics proposes not to install an external SPD at LED module side because it would be unsafe attributable to when this device would be triggered, a high common mode current will generate through driver and SPD that will cause some unexpected and irreversible damage to the driver.

### 9. Warranty Policy

Please reach out our [Warranty Policy](#) should you require any further clarification.

### 10. Attention

Delta provides all information in the datasheets on an “AS IS” basis and does not offer any kind of warranty through the information for using the product. In the event of any discrepancy between the information in the catalog and datasheets, the datasheets shall prevail (please refer to <http://www.DeltaPSU.com> for the latest datasheets information). Delta shall have no liability of indemnification for any claim or action arising from any error for the provided information in the datasheets. Customer shall take its responsibility for evaluation of using the product before placing an order with Delta.

# Mouser Electronics

Authorized Distributor

Click to View Pricing, Inventory, Delivery & Lifecycle Information:

[Delta Electronics:](#)

[EUCO-600200GDA](#)