



Delphi DCM, Non-Isolated Point of Load DC/DC Power Modules: 4.5~14Vin, 0.69-5.0V/12Aout

The Delphi Series DCM, 4.5-14V input, single output, non-isolated Point of Load DC/DC converters are the latest offering from a world leader in power systems technology and manufacturing -- Delta Electronics, Inc. The DCM series provides a programmable output voltage from 0.69 V to 5.0V using an external resistor and has flexible and programmable tracking features to enable a variety of startup voltages as well as tracking between power modules. This product family is available in surface mount and provides up to 12A of output current in an industry standard footprint. With creative design technology and optimization of component placement, these converters possess outstanding electrical and thermal performance, as well as extremely high reliability under highly stressful operating conditions

FEATURES

- High efficiency:
 - 95.4% @ 12Vin, 5.0V/12A out
 - 93.3% @ 12Vin, 3.3V/12A out
 - 91.6% @ 12Vin, 2.5V/12A out
 - 89.2% @ 12Vin, 1.8V/12A out
 - 85.6% @ 12Vin, 1.2V/12A out
 - 80.2% @ 10Vin, 0.69V/12A out
- Small size and low profile: 20.3x 11.4x 8.5mm (0.8"x 0.45"x 0.33")
- Surface mount packaging
- Standard footprint
- Voltage and resistor-based trim
- Pre-bias startup
- Output voltage tracking
- No minimum load required
- Output voltage programmable from 0.69Vdc to 5.0Vdc via external resistor
- Fixed frequency operation
- Input UVLO, output OCP
- Remote on/off
- ISO 9001, TL 9000, ISO 14001, QS9000, OHSAS18001 certified manufacturing facility
- UL/cUL 60950-1 (US & Canada)
- CE mark meets 73/23/EEC and 93/68/EEC directives

OPTIONS

- Negative/Positive on/off logic
- Tracking feature
- Sequence feature

APPLICATIONS

- Telecom / DataCom
- Distributed power architectures
- Servers and workstations
- LAN / WAN applications
- Data processing applications

TECHNICAL SPECIFICATIONS

PARAMETER	NOTES and CONDITIONS	DCM12S0A0S12P(N)FA			
		Min.	Typ.	Max.	Units
ABSOLUTE MAXIMUM RATINGS					
Input Voltage (Continuous)		-0.3		15	V
Sequencing Voltage		-0.3		V _{in} max	V
Operating Ambient Temperature		-40		85	°C
Storage Temperature		-55		125	°C
INPUT CHARACTERISTICS					
Operating Input Voltage	$V_o \leq V_{in} - 0.6$	4.5		14.0	V
Input Under-Voltage Lockout					
Turn-On Voltage Threshold			4.45		V
Turn-Off Voltage Threshold			4.2		V
Lockout Hysteresis Voltage			0.25		V
Maximum Input Current	$V_{in}=4.5V$ to $14V$, $I_o=I_o,max$			11.5	A
No-Load Input Current (VIN = 12.0Vdc, I _o = 0, module enabled)	$V_o,set = 0.69$ Vdc		26		mA
	$V_o,set = 3.3$ Vdc		50		mA
Off Converter Input Current (VIN = 12.0Vdc, module disabled)			1.2		mA
Inrush Transient				1	A2S
Input Reflected Ripple Current, peak-to-peak	(5Hz to 20MHz, 1μH source impedance; V _{in} = 0 to 14V,		12.5		mAp-p
Input Ripple Rejection(120Hz)			45		dB
OUTPUT CHARACTERISTICS					
Output Voltage Set Point	with 0.5% tolerance for external resistor used to set output voltage)	-1.5	V _{o,set}	+1.5	%V _{o,set}
Output Voltage Adjustable Range	(selected by an external resistor)	0.69		5.0	V
Output Voltage Regulation					
Line(V _{in} =V _{in} , min to V _{in} , max)	For V _o ≥2.5V			0.4	%V _{o,set}
	For V _o <2.5V			10	mV
Load(I _o =I _o , min to I _o , max)	For V _o ≥2.5V			10	mV
	For V _o <2.5V			5	mV
Temperature(T _{ref} =T _A , min to T _A , max)	For V _o ≥2.5V			0.5	%V _{o,set}
	For V _o <2.5V			5	mV
Total Output Voltage Range	Over sample load, line and temperature	-2.5		+2.5	%V _{o,set}
Output Voltage Ripple and Noise	5Hz to 20MHz bandwidth				
Peak-to-Peak	Full Load, 1μF+10uF+47uF ceramic		65	80	mV
RMS	Full Load, 1μF+10uF+47uF ceramic		23	28	mV
Output Current Range		0		12	A
Output Voltage Over-shoot at Start-up				5	% V _{o,set}
Output DC Current-Limit Inception			150		% I _o
Output Short-Circuit Current (Hiccup Mode)	I _{o,s/c}		2		Adc
DYNAMIC CHARACTERISTICS					
Dynamic Load Response	10μF Tan & 1μF Ceramic load cap, 1A/μs				
Positive Step Change in Output Current	0% I _o , max to 50% I _o , max		360		mV
Negative Step Change in Output Current	50% I _o , max to 0% I _o , max		400		mV
Settling Time to 10% of Peak Deviation			50		μs
Turn-On Transient	I _o =I _{o,max}				
Delay Time, From On/Off Control	Time for V _{on/off} to V _o =10% of V _{o,set}		4		ms
Delay Time, From Input	Time for V _{in} =V _{in,min} to V _o =10% of V _{o,set}		3.5		ms
Output Voltage Rise Time	Time for V _o to rise from 10% to 90% of V _{o,set}		5		ms
Output Capacitive Load	Full load; ESR ≥ 0.15mΩ	47		800	μF
EFFICIENCY					
V _o =5.0V	V _{in} =12V, 100% Load		95.4		%
V _o =3.3V	V _{in} =12V, 100% Load		93.3		%
V _o =2.5V	V _{in} =12V, 100% Load		91.6		%
V _o =1.8V	V _{in} =12V, 100% Load		89.2		%
V _o =1.2V	V _{in} =12V, 100% Load		85.6		%
V _o =0.69V	V _{in} =10V, 100% Load		80.2		%
FEATURE CHARACTERISTICS					
Switching Frequency			500		kHz
Synchronization Frequency Range		520		600	kHz
ON/OFF Control, (Negative logic)					
Logic Low Voltage	Module On, V _{on/off}	0		1	V
Logic High Voltage	Module Off, V _{on/off}	2.0		V _{in,max}	V
Logic Low Current	Module On, I _{on/off}			10	μA
Logic High Current	Module Off, I _{on/off}			1	mA
ON/OFF Control, (Positive Logic)					
Logic High Voltage	Module On, V _{on/off}	V _{in} -1		V _{in,max}	V
Logic Low Voltage	Module Off, V _{on/off}			3.5	V
Logic Low Current	Module On, I _{on/off}			3	mA
Logic High Current	Module Off, I _{on/off}			25	μA
Tracking Slew Rate Capability				0.5	V/msec
Tracking Delay Time	Delay from V _{in,min} to application of tracking voltage	10			ms
Tracking Accuracy	Power-up 0.5V/mS			100	mV
	Power-down 0.5V/mS			150	mV
GENERAL SPECIFICATIONS					
MTBF	I _o =80% of I _o , max; T _a =25°C	22			M hours
Weight			3.8		grams

(T_A = 25°C, airflow rate = 300 LFM, V_{in} = 4.5Vdc and 14.0Vdc, nominal V_{out} unless otherwise noted.)

ELECTRICAL CHARACTERISTICS CURVES

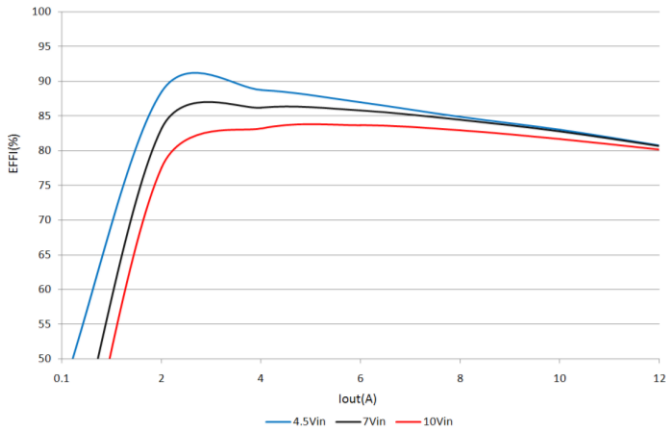

Figure 1: Converter efficiency vs. output current (0.69Vout)

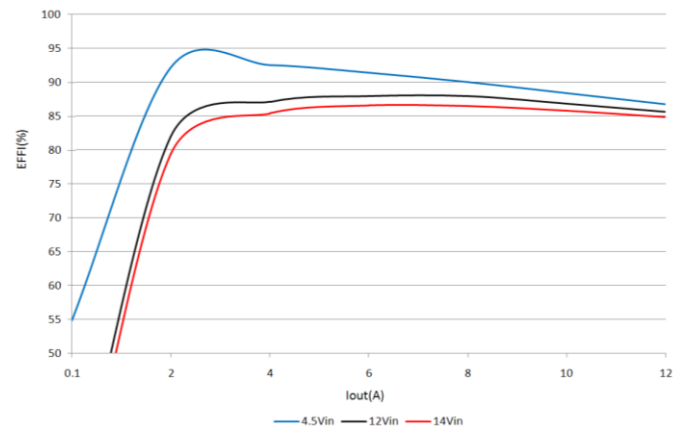

Figure 2: Converter efficiency vs. output current (1.2Vout)

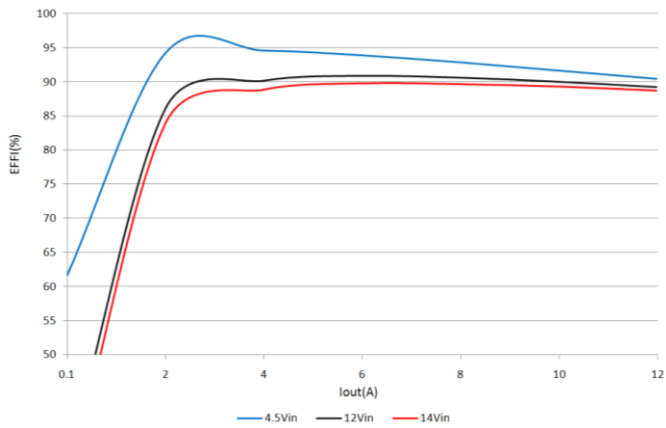

Figure 3: Converter efficiency vs. output current (1.8Vout)

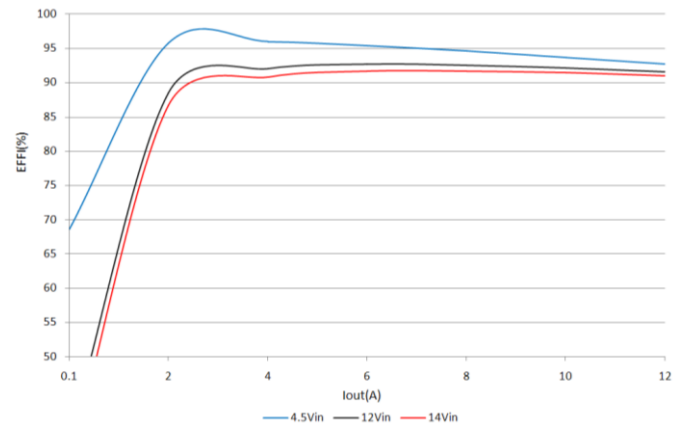

Figure 4: Converter efficiency vs. output current (2.5Vout)

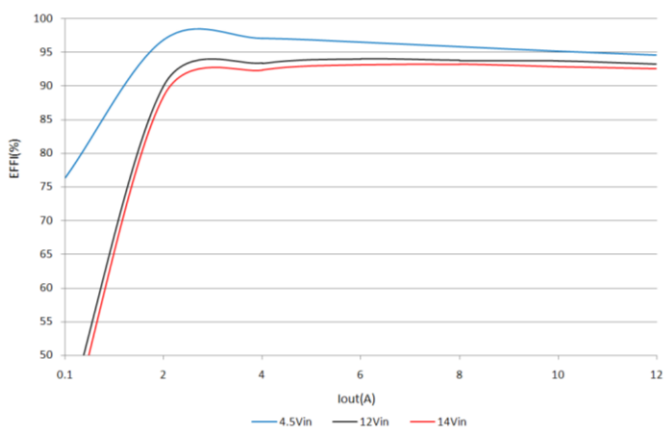

Figure 5: Converter efficiency vs. output current 3.3Vout)

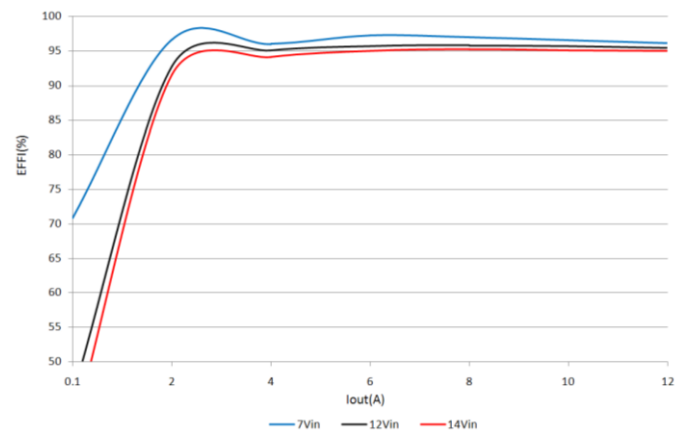

Figure 6: Converter efficiency vs. output current (5.0Vout)

ELECTRICAL CHARACTERISTICS CURVES(CON.)

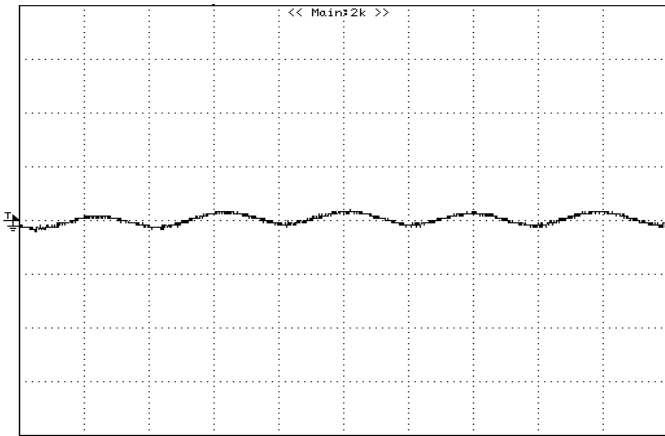

Figure 7: Output ripple & noise at 7Vin, 0.69V/12A out
CH1:VOUT, 20mV/div, 1uS/div

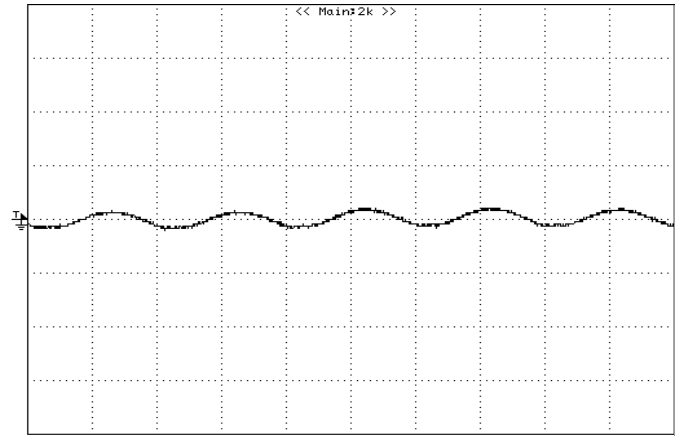

Figure 8: Output ripple & noise at 12Vin, 1.2V/12A out
CH1:VOUT, 20mV/div, 1uS/div

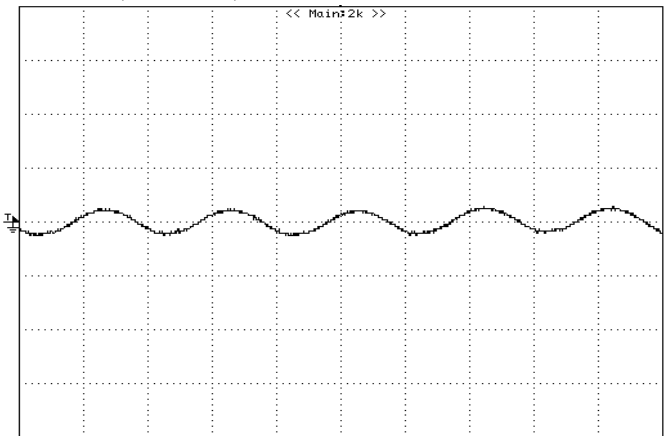

Figure 9: Output ripple & noise at 12Vin, 1.8V/12A out
CH1:VOUT, 20mV/div, 1uS/div

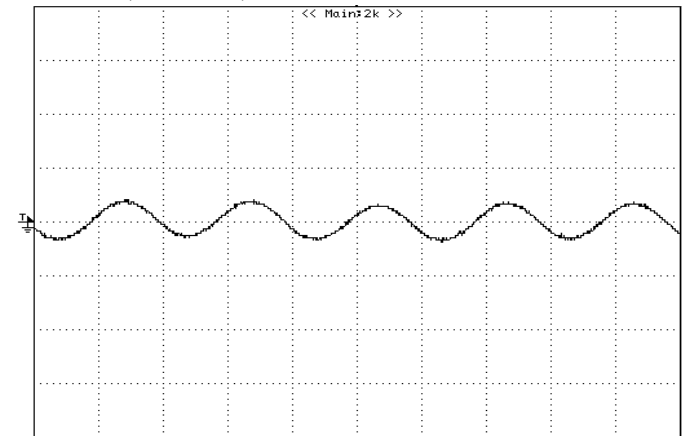

Figure 10: Output ripple & noise at 12Vin, 2.5V/12A out
CH1:VOUT, 20mV/div, 1uS/div

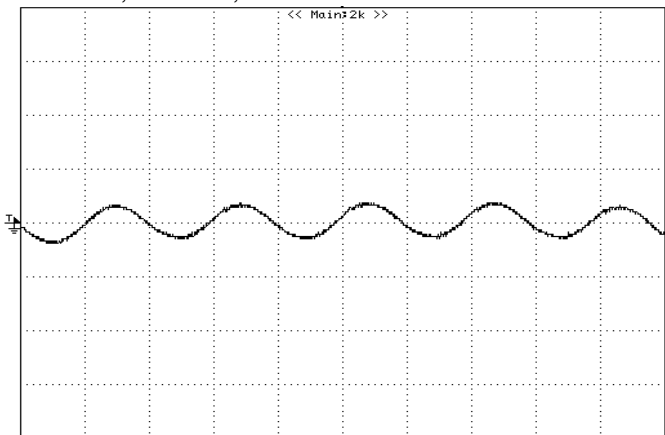

Figure 11: Output ripple & noise at 12Vin, 3.3V/12A out
CH1:VOUT, 20mV/div, 1uS/div

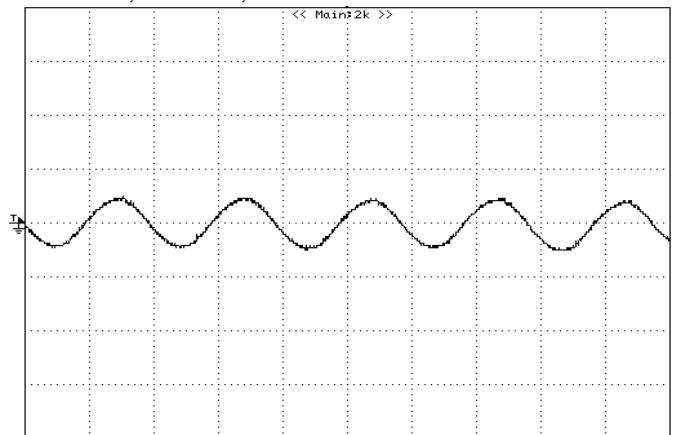

Figure 12: Output ripple & noise at 12Vin, 5.0V/12A out
CH1:VOUT, 20mV/div, 1uS/div

ELECTRICAL CHARACTERISTICS CURVES(CON.)

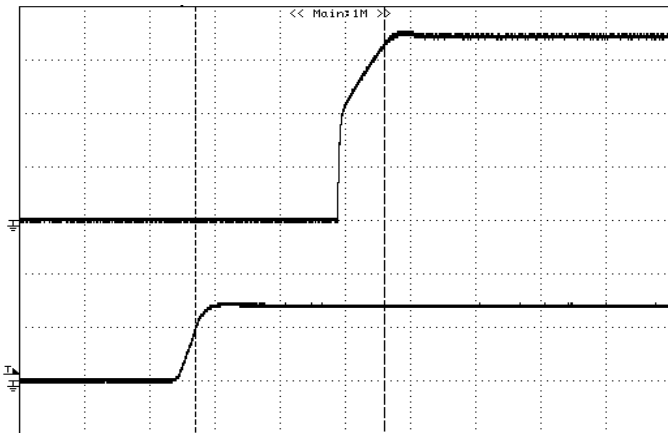

Figure 13: Turn on delay time at 7Vin, 0.69V/12A out.
(Top: VOUT, 0.2V/div; Bottom: VIN, 5V/div; 2mS/div)

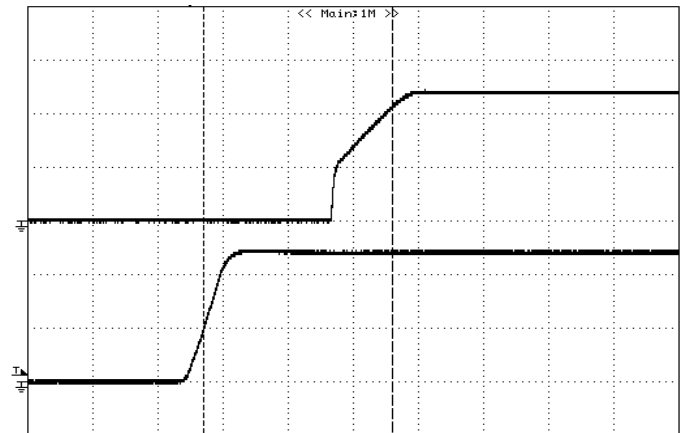

Figure 14: Turn on delay time at 12Vin, 1.2V/12A out.
(Top: VOUT, 0.5V/div; Bottom: VIN, 5V/div; 2mS/div)

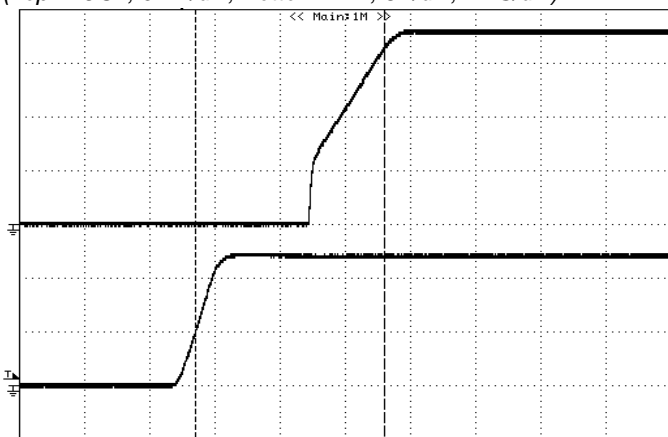

Figure 15: Turn on delay time at 12Vin, 1.8V/12A out.
(Top: VOUT, 0.5V/div; Bottom: VIN, 5V/div; 2mS/div)

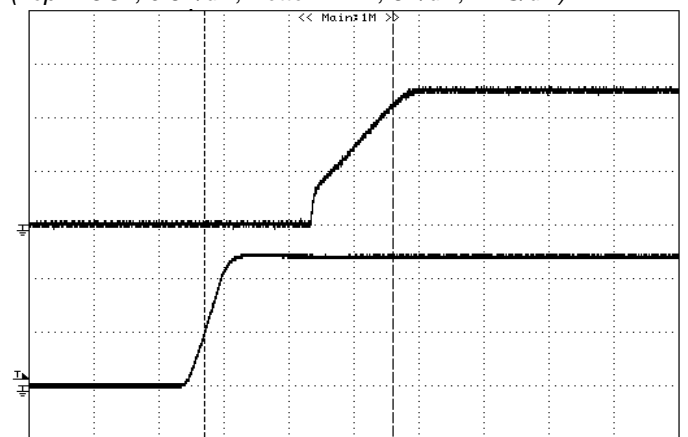

Figure 16: Turn on delay time at 12Vin, 2.5V/12A out.
(Top: VOUT, 1V/div; Bottom: VIN, 5V/div; 2mS/div)

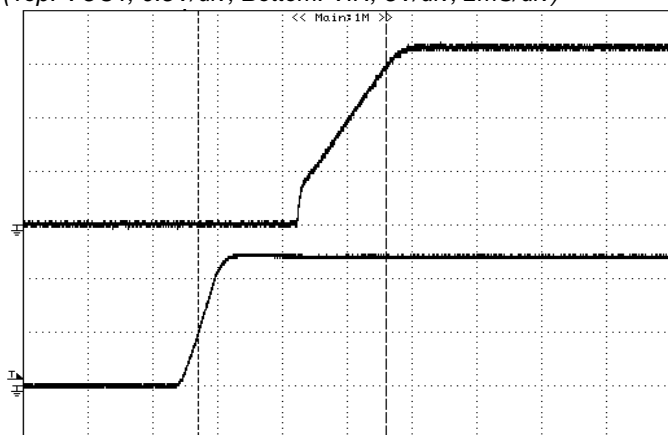

Figure 17: Turn on delay time at 12Vin, 3.3V/12A out.
(Top: VOUT, 1V/div; Bottom: VIN, 5V/div; 2mS/div)

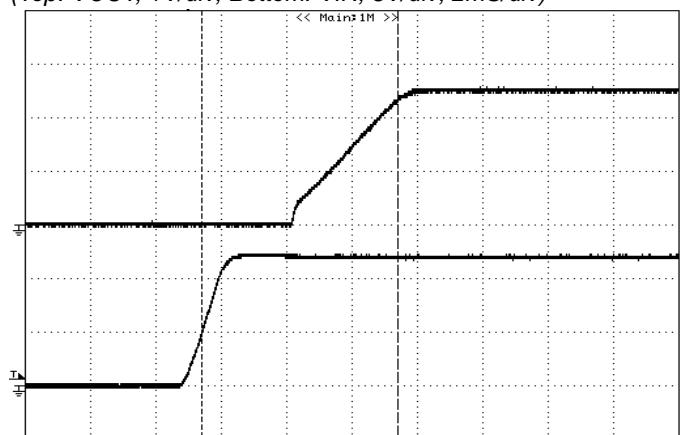

Figure 18: Turn on delay time at 12Vin, 5.0V/12A out.
(Top: VOUT, 2V/div; Bottom: VIN, 5V/div; 2mS/div)

ELECTRICAL CHARACTERISTICS CURVES(CON.)

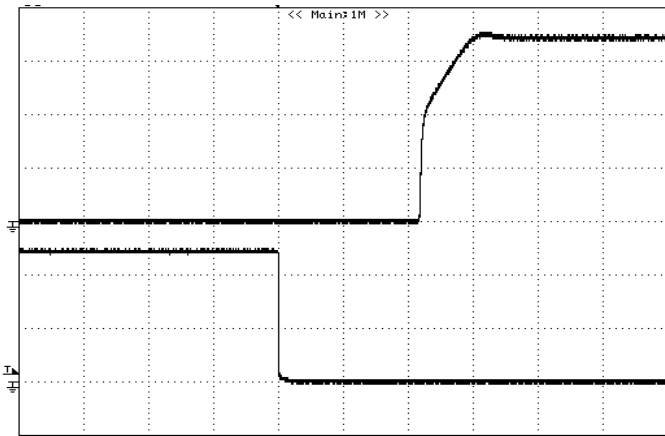

Figure 19: Turn on delay time at remote on 7Vin, 0.69V/12A out.
(Top: VOUT, 0.2V/div; Bottom: ON/OFF, 2V/div; 2mS/div)

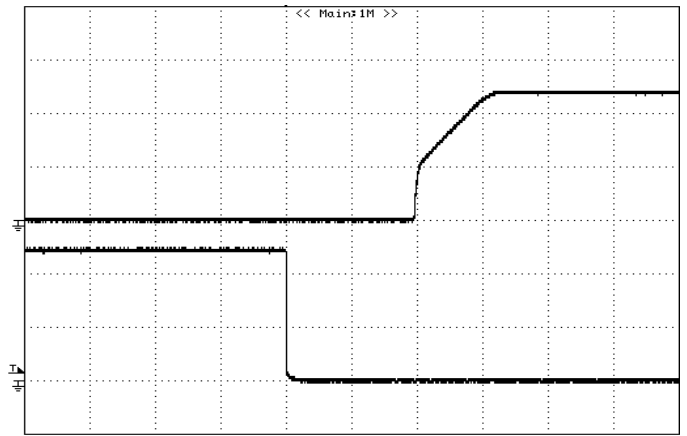

Figure 20: Turn on delay time at remote on 12Vin, 1.2V/12A out.
(Top: VOUT, 0.5V/div; Bottom: ON/OFF, 2V/div; 2mS/div)

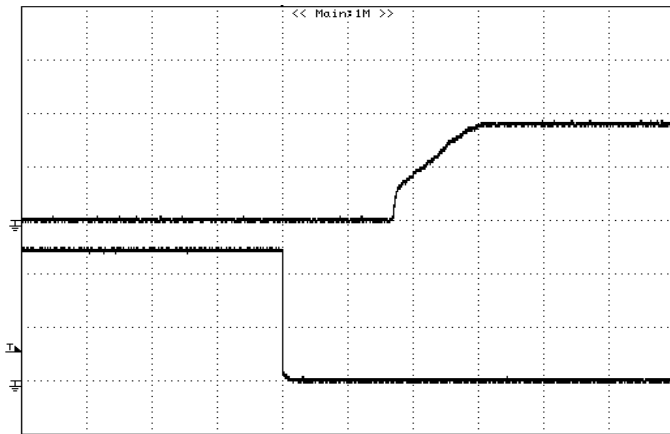

Figure 21: Turn on delay time at remote on 12Vin, 1.8V/12A out.
(Top: VOUT, 1V/div; Bottom: ON/OFF, 2V/div; 2mS/div)

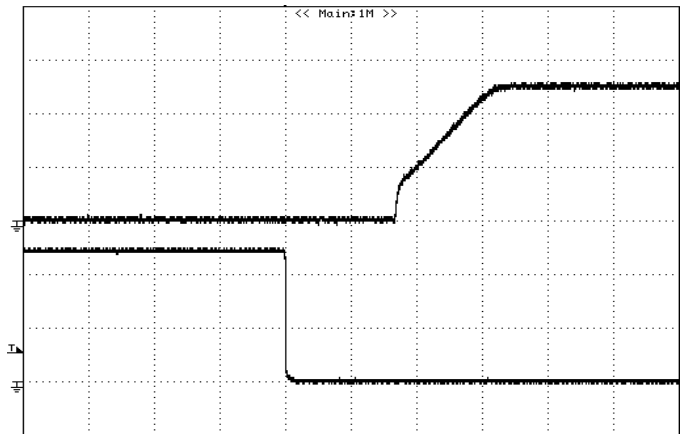

Figure 22: Turn on delay time at remote on 12Vin, 2.5V/12A out.
(Top: VOUT, 1V/div; Bottom: ON/OFF, 2V/div; 2mS/div)

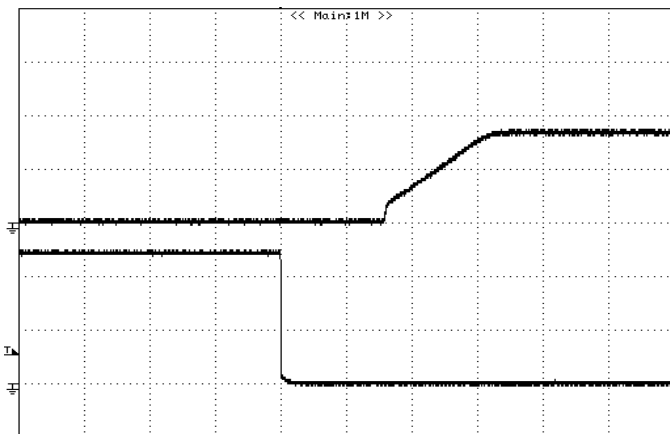

Figure 23: Turn on delay time at remote on 12Vin, 3.3V/12A out.
(Top: VOUT, 2V/div; Bottom: ON/OFF, 2V/div; 2mS/div)

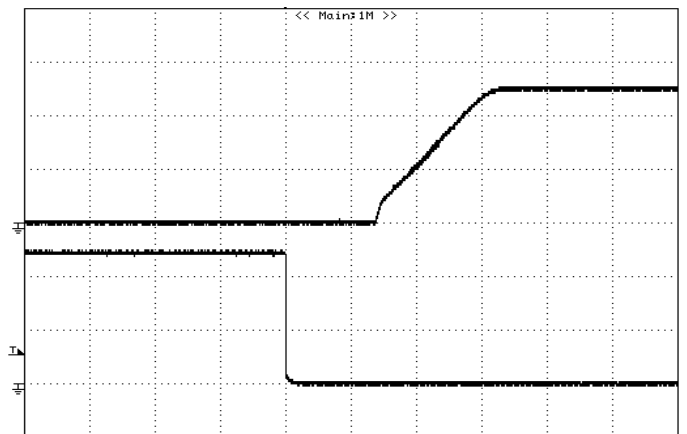

Figure 24: Turn on delay time at remote on 12Vin, 5.0V/12A out.
(Top: VOUT, 0.2V/div; Bottom: ON/OFF, 2V/div; 2mS/div)

ELECTRICAL CHARACTERISTICS CURVES(CON.)

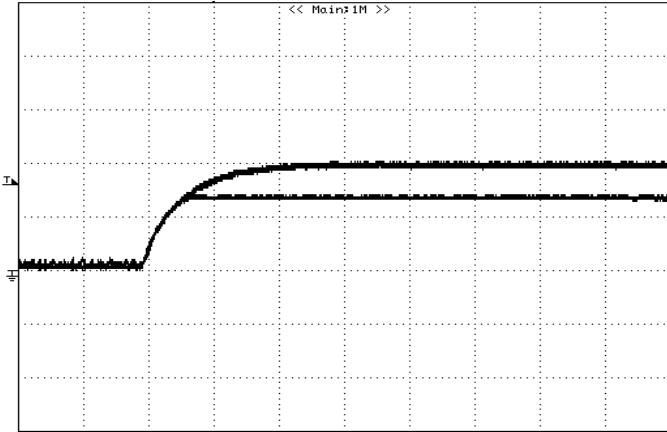

Figure 25: Tracking function, $V_{tracking}=1V$, $V_{out}= 0.69V$, full load
(Top: V_{OUT} , 0.5V/div; Bottom: Tracking, 0.5V/div, 500uS/div)

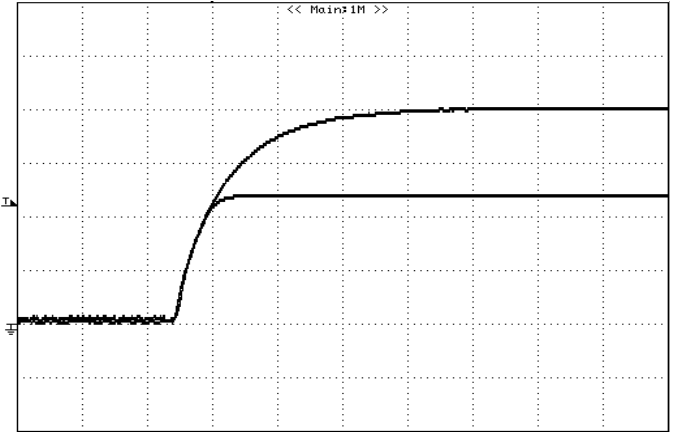

Figure 26: Tracking function, $V_{tracking}=2V$, $V_{out}= 1.2V$, full load
(Top: V_{OUT} , 0.5V/div; Bottom: Tracking, 0.5V/div, 500uS/div)

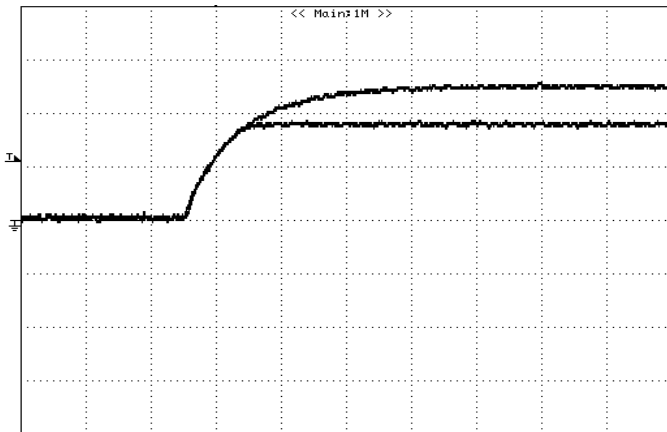

Figure 27: Tracking function, $V_{tracking}=2.5V$, $V_{out}= 1.8V$, full load
(Top: V_{OUT} , 1V/div; Bottom: Tracking, 1V/div, 500uS/div)

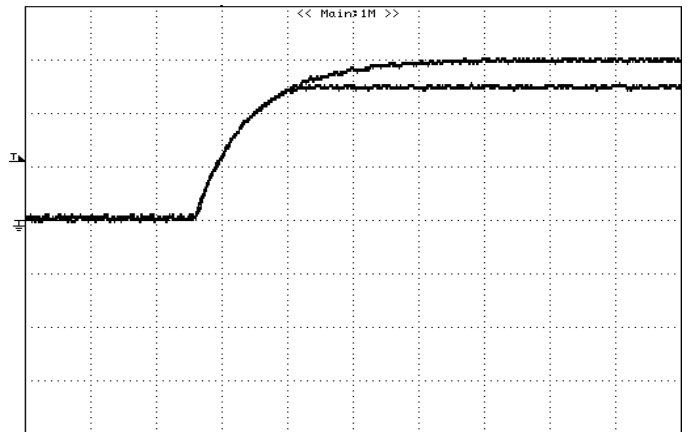

Figure 28: Tracking function, $V_{tracking}=3V$, $V_{out}= 2.5V$, full load
(Top: V_{OUT} , 1V/div; Bottom: Tracking, 1V/div, 500uS/div)

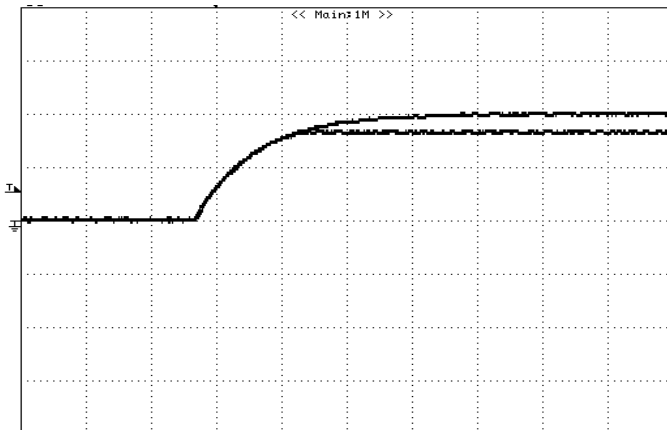

Figure 29: Tracking function, $V_{tracking}=4V$, $V_{out}= 3.3V$, full load
(Top: V_{OUT} , 2V/div; Bottom: Tracking, 2V/div, 500uS/div)

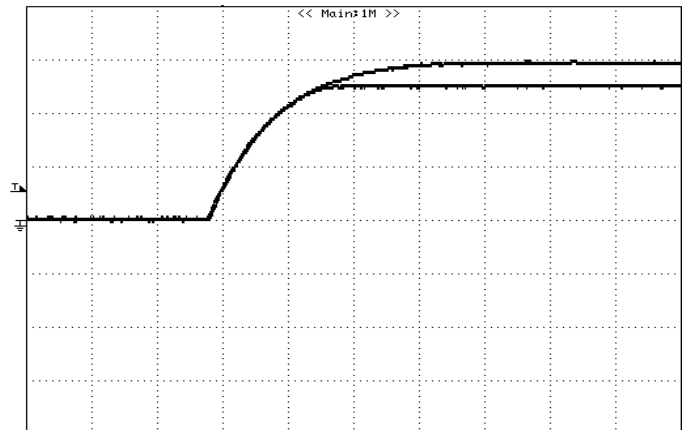

Figure 30: Tracking function, $V_{tracking}=6V$, $V_{out}= 5.0V$, full load
(Top: V_{OUT} , 2V/div; Bottom: Tracking, 2V/div, 500uS/div)

ELECTRICAL CHARACTERISTICS CURVES(CON.)

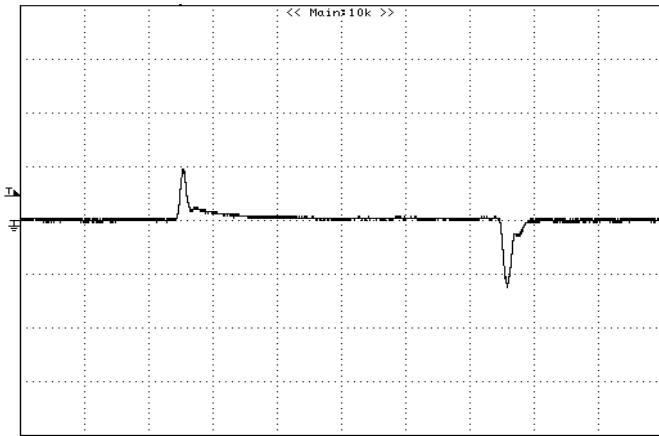

Figure 31: Typical transient response to step load change at $1A/\mu S$ from 0%~ 50%~0% of I_o , max at $7V_{in}$, $0.69V_{out}$
($C_{out} = 1\mu F$ ceramic, $47\mu F+10\mu F$ ceramic)
CH1 : VOUT, 0.2V/div, 100uS/div

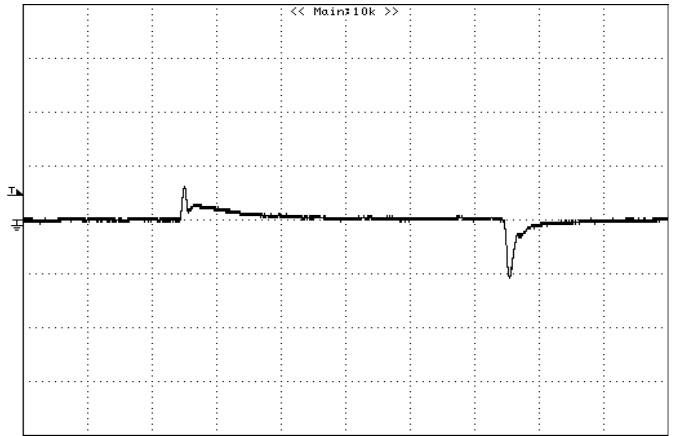

Figure 32: Typical transient response to step load change at $1A/\mu S$ from 0%~ 50%~0% of I_o , max at $12V_{in}$, $1.2V_{out}$
($C_{out} = 1\mu F$ ceramic, $47\mu F+10\mu F$ ceramic)
CH1 : VOUT, 0.2V/div, 100uS/div

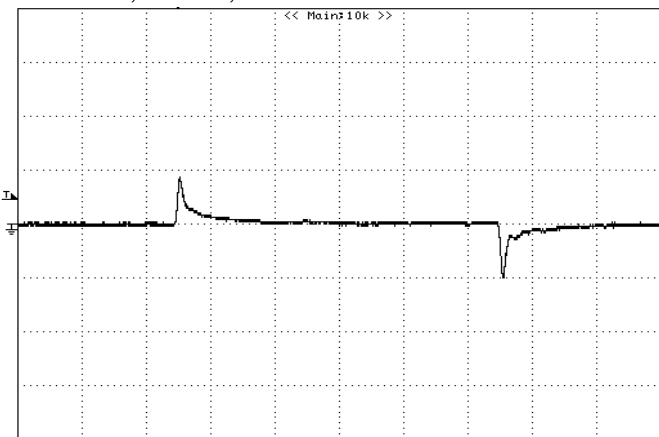

Figure 33: Typical transient response to step load change at $1A/\mu S$ from 0%~ 50%~0% of I_o , max at $12V_{in}$, $1.8V_{out}$
($C_{out} = 1\mu F$ ceramic, $47\mu F+10\mu F$ ceramic)
CH1 : VOUT, 0.2V/div, 100uS/div

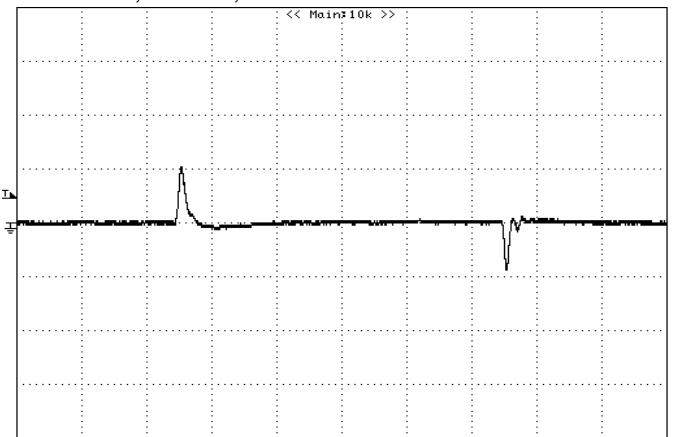

Figure 34: Typical transient response to step load change at $1A/\mu S$ from 0%~ 50%~0% of I_o , max at $12V_{in}$, $2.5V_{out}$
($C_{out} = 1\mu F$ ceramic, $47\mu F+10\mu F$ ceramic)
CH1: VOUT, 0.2V/div, 100uS/div

ELECTRICAL CHARACTERISTICS CURVES(CON.)

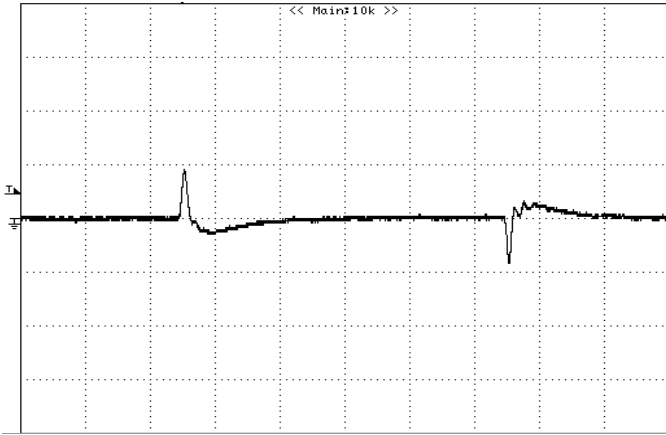

Figure 35: Typical transient response to step load change at $1A/\mu S$ from 0%~ 50%~0% of I_o , max at $12V_{in}$, $3.3V_{out}$
($C_{out} = 1\mu F$ ceramic, $47\mu F + 10\mu F$ ceramic)
CH1 : V_{OUT} , 0.2V/div, 100 μS /div

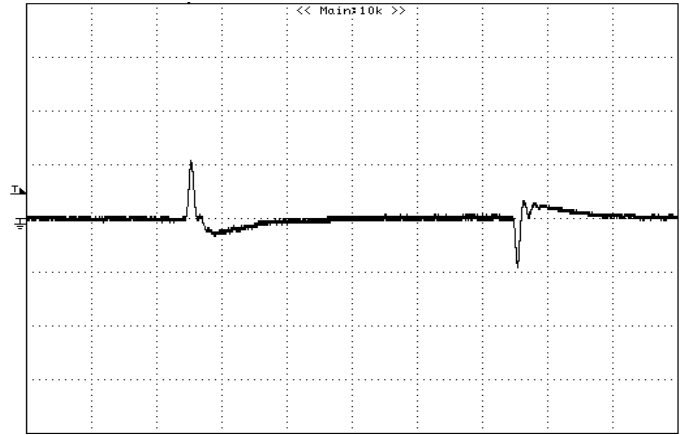
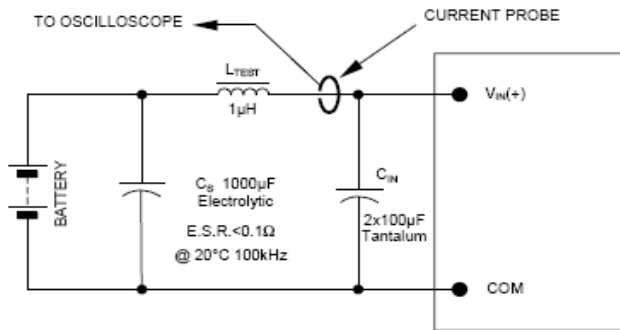

Figure 36: Typical transient response to step load change at $1A/\mu S$ from 0%~ 50%~0% of I_o , max at $12V_{in}$, $5.0V_{out}$
($C_{out} = 1\mu F$ ceramic, $47\mu F + 10\mu F$ ceramic)
CH1 : V_{OUT} , 0.2V/div, 100 μS /div

TEST CONFIGURATIONS



NOTE: Measure input reflected ripple current with a simulated source inductance (L_{TEST}) of $1\mu\text{H}$. Capacitor C_B offsets possible battery impedance. Measure current as shown above.

Figure 37: Input reflected-ripple test setup

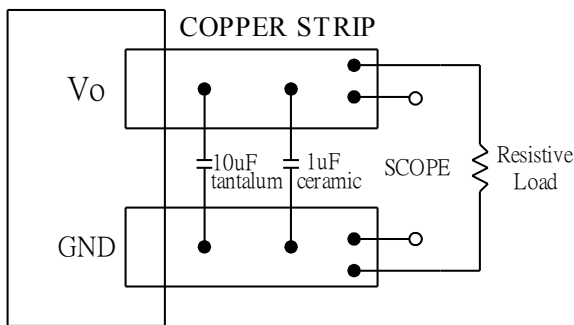

Note: Use a $10\mu\text{F}$ tantalum and $1\mu\text{F}$ capacitor. Scope measurement should be made using a BNC connector.

Figure 38: Peak-peak output noise and startup transient measurement test setup.

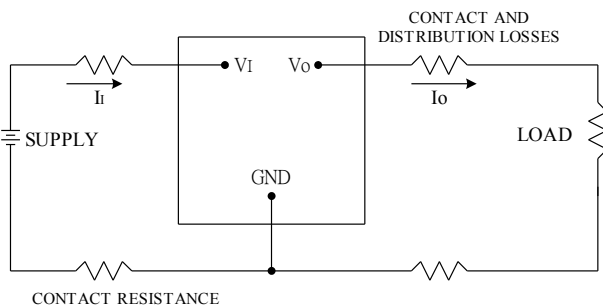

Figure 39: Output voltage and efficiency measurement test setup

Note: All measurements are taken at the module terminals. When the module is not soldered (via socket), place Kelvin connections at module terminals to avoid measurement errors due to contact resistance.

$$\eta = \left(\frac{V_o \times I_o}{V_i \times I_i} \right) \times 100 \quad \%$$

DESIGN CONSIDERATIONS

Input Source Impedance

To maintain low noise and ripple at the input voltage, it is critical to use low ESR capacitors at the input to the module. A highly inductive source can affect the stability of the module. An input capacitance must be placed close to the module's input pins to filter ripple current and ensure module stability in the presence of inductive traces that supply the input voltage to the module.

Safety Considerations

For safety-agency approval the power module must be installed in compliance with the spacing and separation requirements of the end-use safety agency standards.

For the converter output to be considered meeting the requirements of safety extra-low voltage (SELV), the input must meet SELV requirements. The power module has extra-low voltage (ELV) outputs when all inputs are ELV.

The input to these units is to be provided with a fast acting fuse with a maximum rating of 15A in the positive input lead.

Input Under voltage Lockout

At input voltages below the input under voltage lockout limit, the module operation is disabled. The module will begin to operate at an input voltage above the under voltage lockout turn-on threshold.

Over-Current Protection

To provide protection in an output over load fault condition, the unit is equipped with internal over-current protection. When the over-current protection is triggered, the unit enters hiccup mode. The units operate normally once the fault condition is removed.

Remote On/Off

The DCM series power modules have an On/Off pin for remote On/Off operation. Both positive and negative On/Off logic options are available in the DCM series power modules.

For positive logic module, connect an open collector (NPN) transistor or open drain (N channel) MOSFET between the On/Off pin and the GND pin (see figure 40). Positive logic On/Off signal turns the module ON during the logic high and turns the module OFF during the logic low. When the positive On/Off function is not used, leave the pin floating or tie to V_{in} (module will be On).

For negative logic module, the On/Off pin is pulled high with an external pull-up 5k Ω resistor (see figure 41). Negative logic On/Off signal turns the module OFF during logic high and turns the module ON during logic low. If the negative On/Off function is not used, leave the pin floating or tie to GND. (module will be on)

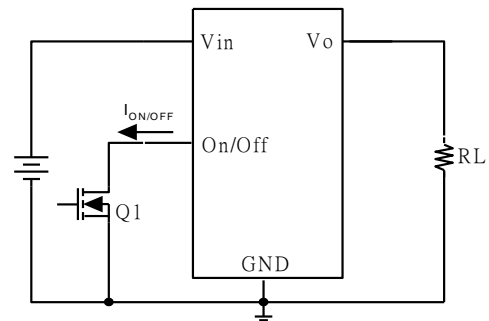

Figure 40: Positive remote On/Off implementation

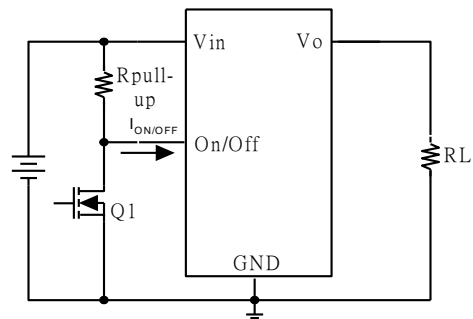

Figure 41: Negative remote On/Off implementation

FEATURES DESCRIPTIONS (CON.)

Remote Sense

The DCM provide V_o remote sensing to achieve proper regulation at the load points and reduce effects of distribution losses on output line. In the event of an open remote sense line, the module shall maintain local sense regulation through an internal resistor. The module shall correct for a total of 0.5V of loss. The remote sense line impedance shall be $< 10\Omega$.

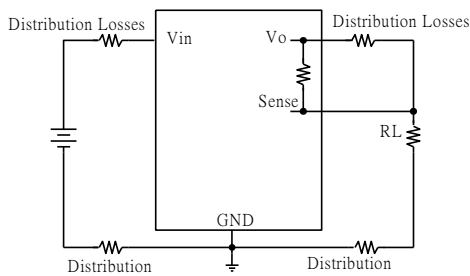

Figure 42: Effective circuit configuration for remote sense operation

Output Voltage Programming

The output voltage of the DCM can be programmed to any voltage between 0.69Vdc and 5.0Vdc by connecting one resistor (shown as R_{trim} in Figure 43) between the TRIM and GND pins of the module. Without this external resistor, the output voltage of the module is 0.69 Vdc. To calculate the value of the resistor R_{trim} for a particular output voltage V_o , please use the following equation:

$$R_{trim} = \left[\frac{6.9}{V_o - 0.69} \right] K\Omega$$

R_{trim} is the external resistor in $k\Omega$

V_o is the desired output voltage.

For example, to program the output voltage of the DCM module to 5.0Vdc, R_{trim} is calculated as follows:

$$R_{trim} = \left[\frac{6.9}{5.0 - 0.69} \right] K\Omega = 1.601 K\Omega$$

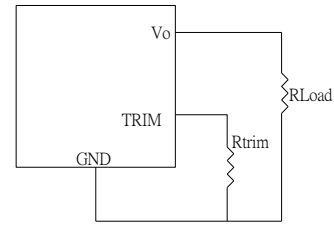

Figure 43: Circuit configuration for programming output voltage using an external resistor

Table 1 provides R_{trim} values required for some common output voltages, By using a 0.5% tolerance trim resistor, set point tolerance of $\pm 1.5\%$ can be achieved as specified in the electrical specification.

Table 1

$V_{o, set}$ (V)	R_{trim} (K Ω)
0.7	690
1.0	22.26
1.2	13.53
1.5	8.519
1.8	6.216
2.5	3.812
3.3	2.644
5.0	1.601

Certain restrictions apply on the output voltage set point depending on the input voltage. These are shown in the Output Voltage vs. Input Voltage Set Point Area plot in Figure 44. The Upper Limit curve shows that for output voltages of 0.9V and lower, the input voltage must be lower than the maximum of 14V. The Lower Limit curve shows that for output voltages of 3.3V and higher, the input voltage needs to be larger than the minimum of 4.5V.

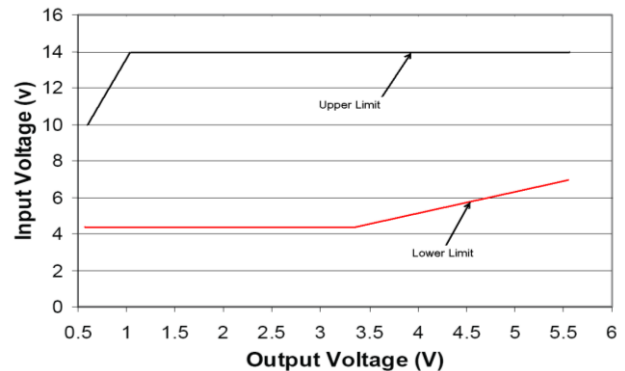

Figure 44: Output Voltage vs. Input Voltage Set Point Area plot showing limits where the output voltage can be set for different input voltages.

FEATURE DESCRIPTIONS (CON.)

Voltage Margining

Output voltage margining can be implemented in the DCM modules by connecting a resistor, R_{margin-up}, from the Trim pin to the ground pin for margining-up the output voltage and by connecting a resistor, R_{margin-down}, from the Trim pin to the output pin for margining-down. Figure 45 shows the circuit configuration for output voltage margining. If unused, leave the trim pin unconnected. A calculation tool is available from the evaluation procedure which computes the values of R_{margin-up} and R_{margin-down} for a specific output voltage and margin percentage.

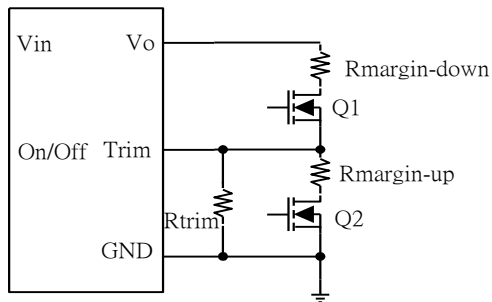

Figure 45: Circuit configuration for output voltage margining

Output Voltage Sequencing

The DCM 12V 12A modules include a sequencing feature, EZ-SEQUENCE that enables users to implement various types of output voltage sequencing in their applications. This is accomplished via an additional sequencing pin. When not using the sequencing feature, either tie the SEQ pin to VIN or leave it unconnected.

When an analog voltage is applied to the SEQ pin, the output voltage tracks this voltage until the output reaches the set-point voltage. The final value of the SEQ voltage must be set higher than the set-point voltage of the module. The output voltage follows the voltage on the SEQ pin on a one-to-one basis. By connecting multiple modules together, multiple modules can track their output voltages to the voltage applied on the SEQ pin. For proper voltage sequencing, first, input voltage is applied to the module. The On/Off pin of the module is left unconnected (or tied to GND for negative logic modules or tied to VIN for positive logic modules) so that the module is ON by default. After applying input voltage to the module, a minimum 10msec delay is required before applying voltage on the SEQ pin. This delay gives the module enough time to complete its internal power-up soft-start cycle. During the delay time, the SEQ pin should be held close to ground (nominally 50mV ± 20 mV). This is required to keep the internal op-amp out of saturation thus preventing output overshoot during the start of the sequencing ramp. By selecting resistor R1 (see Figure 47) according to the following equation

$$R1 = \left[\frac{24950}{V_{in} - 0.05} \right] \Omega$$

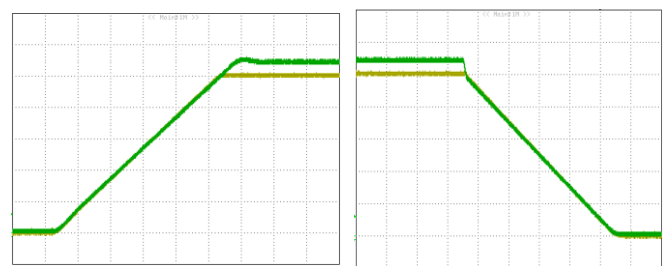

Figure 46: Sequential Start-up

The voltage at the sequencing pin will be 50mV when the sequencing signal is at zero.

FEATURE DESCRIPTIONS (CON.)

After the 10msec delay, an analog voltage is applied to the SEQ pin and the output voltage of the module will track this voltage on a one-to-one volt bases until the output reaches the set-point voltage. To initiate simultaneous shutdown of the modules, the SEQ pin voltage is lowered in a controlled manner. The output voltage of the modules tracks the voltages below their set-point voltages on a one-to-one basis. A valid input voltage must be maintained until the tracking and output voltages reach ground potential.

When using the EZ-SEQUENCETM feature to control start-up of the module, pre-bias immunity during startup is disabled. The pre-bias immunity feature of the module relies on the module being in the diode-mode during start-up. When using the EZ-SEQUENCETM feature, modules goes through an internal set-up time of 10msec, and will be in synchronous rectification mode when the voltage at the SEQ pin is applied. This will result in the module sinking current if a pre-bias voltage is present at the output of the module.

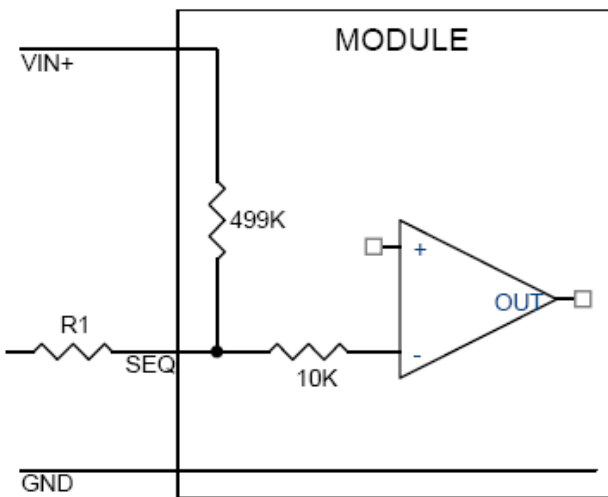

Figure 47: Circuit showing connection of the sequencing signal to the SEQ pin.

Power Good

The DCM modules provide a Power Good (PGOOD) signal that is implemented with an open-drain output to indicate that the output voltage is within the regulation limits of the power module. The PGOOD signal will be de-asserted to a low state if any condition such as over temperature, over current or loss of regulation occurs that would result in the output voltage going $\pm 10\%$ outside the set point value. The PGOOD terminal should be connected through a pull up resistor (suggested value 100K Ω) to a source of 5VDC or lower.

Monotonic Start-up and Shutdown

The DCM 12A modules have monotonic start-up and shutdown behavior for any combination of rated input voltage, output current and operating temperature range.

Synchronization

The DCM 12A modules can be synchronized using an external signal. Details of the SYNC signal are provided in below table. If the synchronization function is not being used, leave the SYNC pin floating.

Parameter [Ⓟ]	Notes [Ⓟ]	Min [Ⓟ]	Nom [Ⓟ]	Max [Ⓟ]	Units [Ⓟ]
Frequency Synchronization [Ⓟ]	[Ⓟ]	[Ⓟ]	[Ⓟ]	[Ⓟ]	[Ⓟ]
Synchronization Frequency Range [Ⓟ]	[Ⓟ]	520 [Ⓟ]	[Ⓟ]	600 [Ⓟ]	kHz [Ⓟ]
High-Level Input Voltage [Ⓟ]	[Ⓟ]	2.5 [Ⓟ]	[Ⓟ]	[Ⓟ]	V [Ⓟ]
Low-Level Input Voltage [Ⓟ]	[Ⓟ]	[Ⓟ]	[Ⓟ]	0.8 [Ⓟ]	V [Ⓟ]
Input Current, SYNC [Ⓟ]	VSYNC=2.5V [Ⓟ]	[Ⓟ]	[Ⓟ]	1 [Ⓟ]	mA [Ⓟ]
Minimum Pulse Width, SYNC [Ⓟ]	[Ⓟ]	250 [Ⓟ]	[Ⓟ]	[Ⓟ]	nS [Ⓟ]
Minimum Setup/Hold Time, SYNC [Ⓟ]	[Ⓟ]	250 [Ⓟ]	[Ⓟ]	[Ⓟ]	nS [Ⓟ]

THERMAL CONSIDERATIONS

Thermal management is an important part of the system design. To ensure proper, reliable operation, sufficient cooling of the power module is needed over the entire temperature range of the module. Convection cooling is usually the dominant mode of heat transfer.

Hence, the choice of equipment to characterize the thermal performance of the power module is a wind tunnel.

Thermal Testing Setup

Delta's DC/DC power modules are characterized in heated vertical wind tunnels that simulate the thermal environments encountered in most electronics equipment. This type of equipment commonly uses vertically mounted circuit cards in cabinet racks in which the power modules are mounted.

The following figure shows the wind tunnel characterization setup. The power module is mounted on a test PWB and is vertically positioned within the wind tunnel.

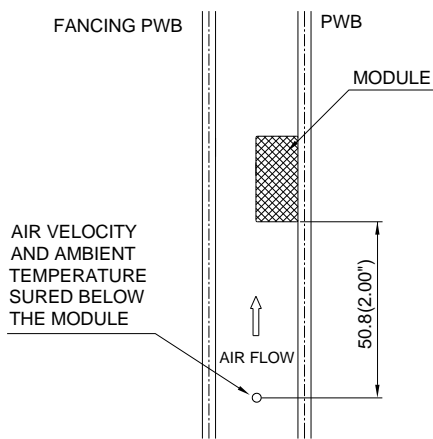

Note: Wind Tunnel Test Setup Figure Dimensions are in millimeters and (Inches)

Figure 48: Wind tunnel test setup

Thermal Derating

Heat can be removed by increasing airflow over the module. To enhance system reliability, the power module should always be operated below the maximum operating temperature. If the temperature exceeds the maximum module temperature, reliability of the unit may be affected.

THERMAL CURVES

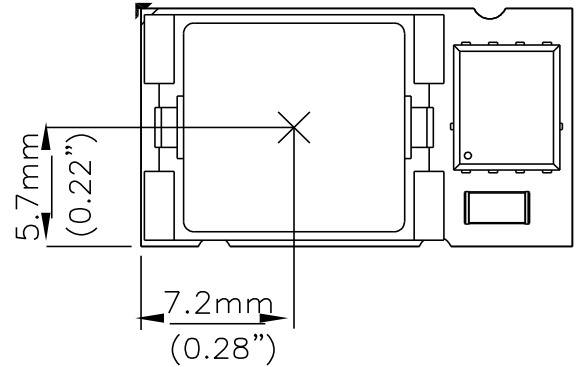

Figure 49: Temperature measurement location
The allowed maximum hot spot temperature is defined at 125°C

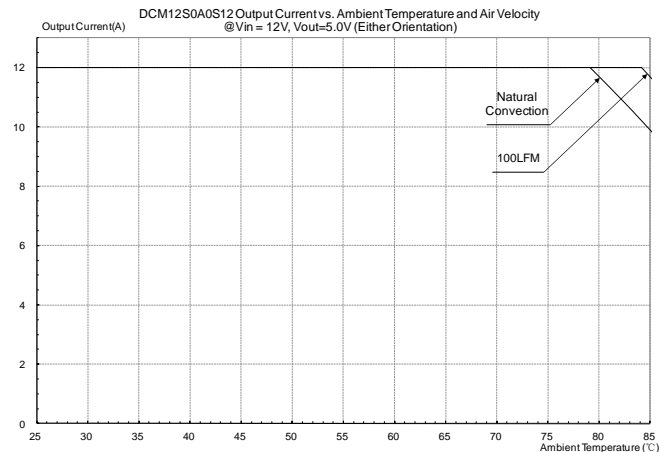

Figure 50: Output current vs. ambient temperature and air velocity @ Vin=12V, Vout=5.0V (Either Orientation)

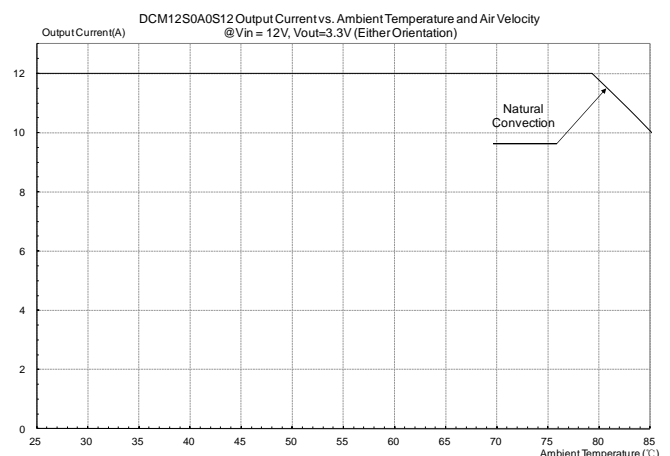

Figure 51: Output current vs. ambient temperature and air velocity @ Vin=12V, Vout=3.3V (Either Orientation)

THERMAL CURVES

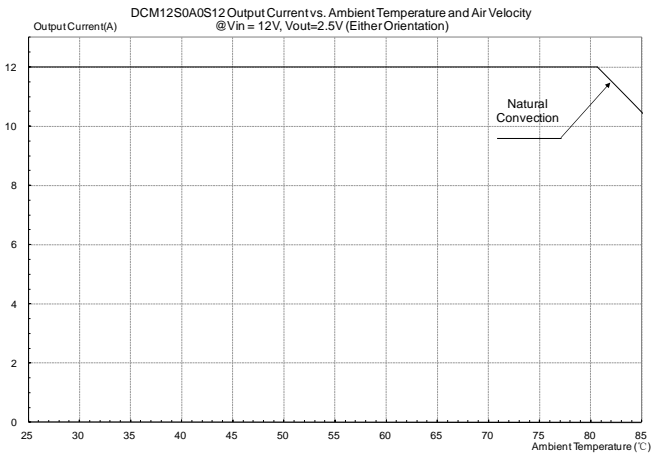

Figure 52: Output current vs. ambient temperature and air velocity @ $V_{in}=12V$, $V_{out}=2.5V$ (Either Orientation)

THERMAL CURVES

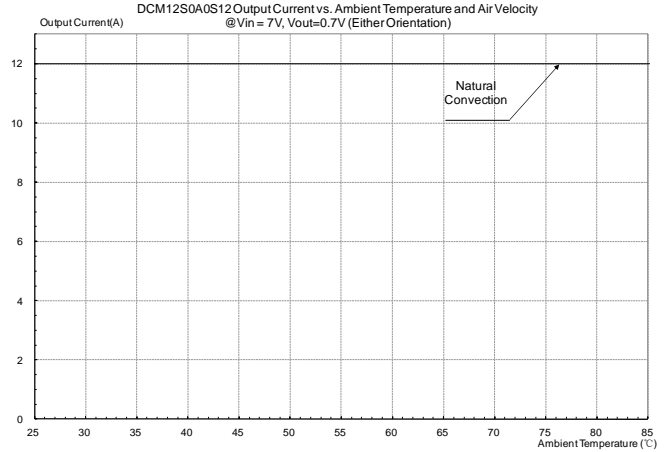

Figure 55: Output current vs. ambient temperature and air velocity @ $V_{in}=7V$, $V_{out}=0.7V$ (Either Orientation)

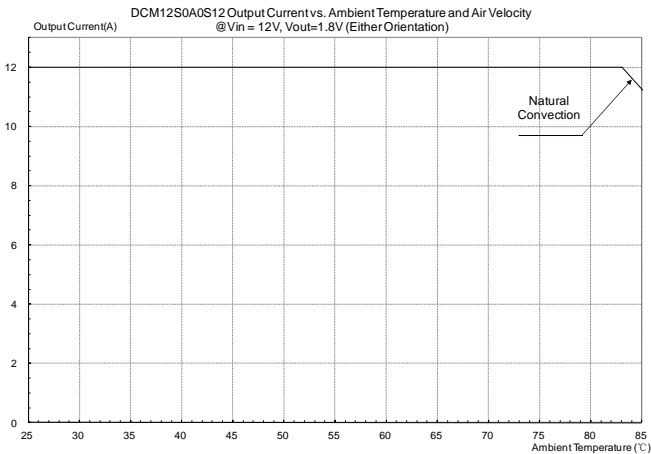

Figure 53: Output current vs. ambient temperature and air velocity @ $V_{in}=12V$, $V_{out}=1.8V$ (Either Orientation)

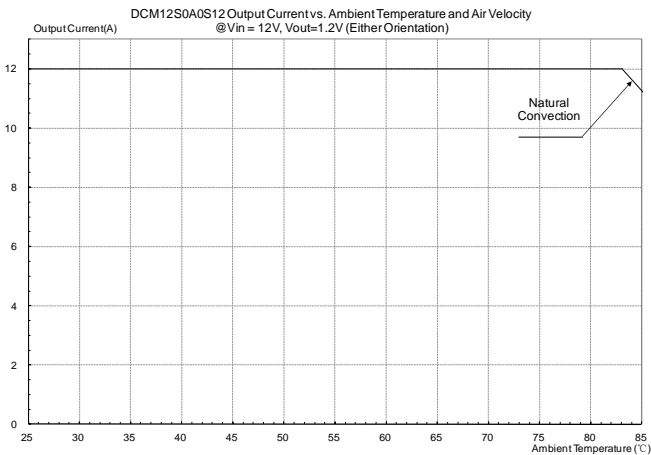
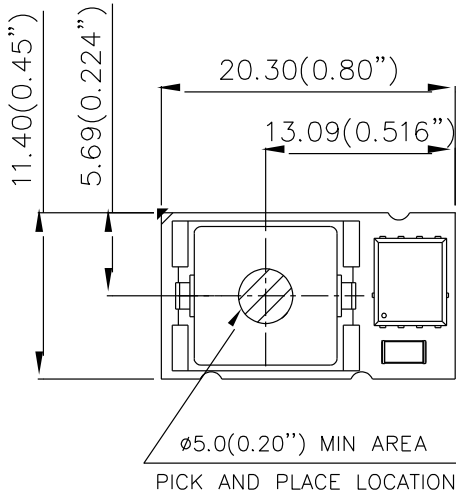

Figure 54: Output current vs. ambient temperature and air velocity @ $V_{in}=12V$, $V_{out}=1.2V$ (Either Orientation)

PICK AND PLACE LOCATION



NOTES:

ALL DIMENSIONS ARE IN MILLIMETERS AND (INCHES)

TOLERANCES: X.Xmm±0.5mm(X.XX in.±0.02 in.)

X.XXmm±0.25mm(X.XXX in.±0.010 in.)

RECOMMENDED PAD LAYOUT

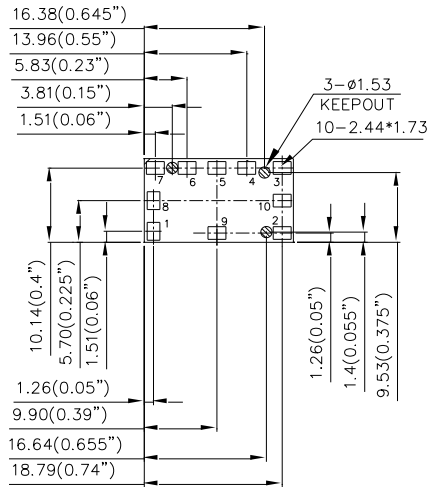

RECOMENDED P.W.B. PAD LAYOUT

NOTES:

DIMENSIONS ARE IN MILLIMETERS AND (INCHES)

TOLERANCES: X.Xmm±0.5mm(X.XX in.±0.02 in.)

X.XXmm±0.25mm(X.XXX in.±0.010 in.)

Pin#	Designation
1	ON/OFF
2	VIN
3	SEQ
4	GND
5	TRIM
6	VOUT
7	VS+
8	VS-
9	PG
10	SYNC

SURFACE-MOUNT TAPE & REEL

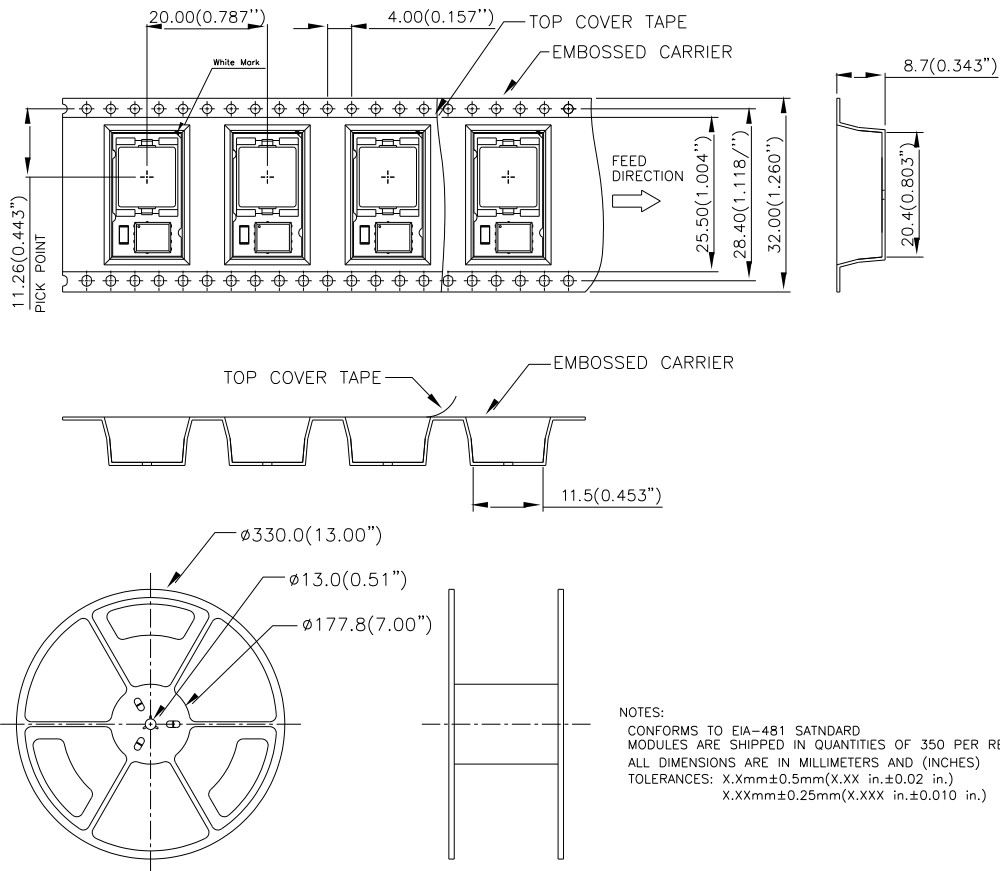

NOTES:

CONFORMS TO EIA-481 SATNDARD
 MODULES ARE SHIPPED IN QUANTITIES OF 350 PER REEL.
 ALL DIMENSIONS ARE IN MILLIMETERS AND (INCHES)
 TOLERANCES: X.Xmm±0.5mm(X.XX in.±0.02 in.)
 X.XXmm±0.25mm(X.XXX in.±0.010 in.)

LEAD (Sn/Pb) PROCESS RECOMMEND TEMP. PROFILE

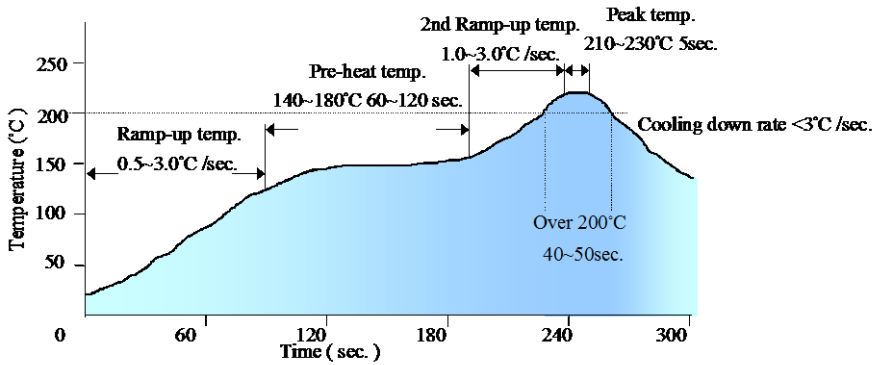

Note: The temperature refers to the pin of DCM, measured on the pin Vout joint.

LEAD FREE (SAC) PROCESS RECOMMEND TEMP. PROFILE

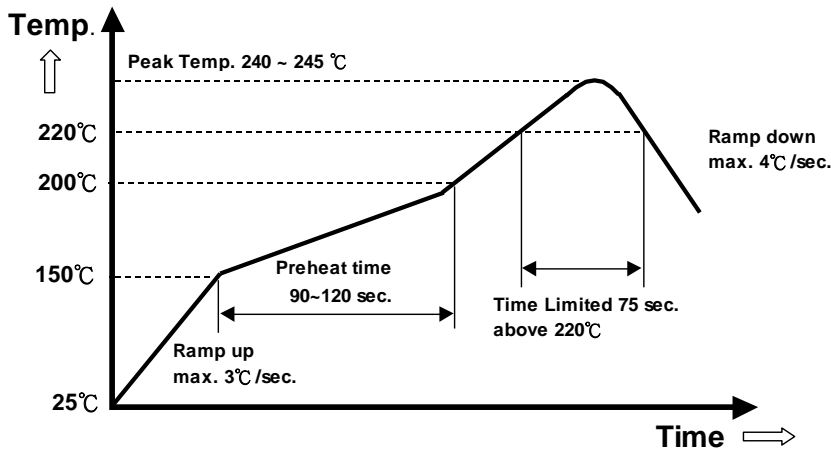

Note: The temperature refers to the pin of DCM, measured on the pin Vout joint.

MECHANICAL DRAWING

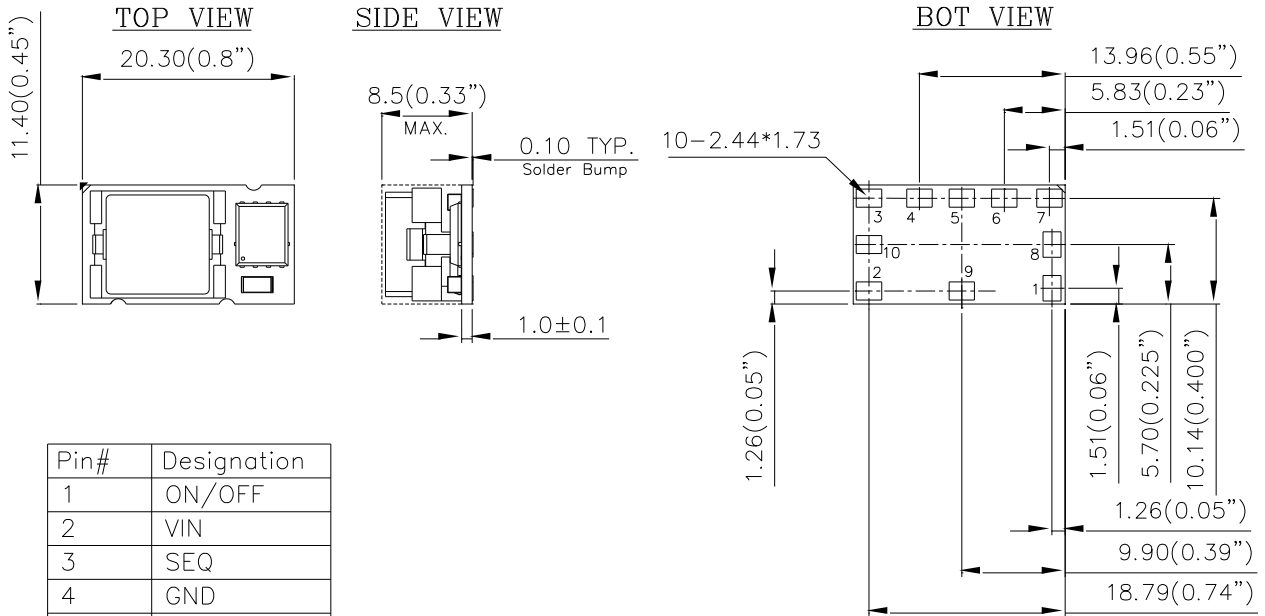

Pin#	Designation
1	ON/OFF
2	VIN
3	SEQ
4	GND
5	TRIM
6	VOUT
7	VS+
8	VS-
9	PG
10	SYNC

NOTES:
 DIMENSIONS ARE IN MILLIMETERS AND (INCHES)
 TOLERANCES: X.Xmm±0.5mm(X.XX in.±0.02 in.)
 [unless otherwise indicated]
 X.XXmm±0.25mm(X.XXX in.±0.010 in.)



PART NUMBERING SYSTEM

DCM	12	S	0A0	S	12	N	F	A
Product Series	Input Voltage	Numbers of Outputs	Output Voltage	Package Type	Output Current	On/Off logic		Option Code
DCT - 3A DCS - 6A DCM - 12A DCL - 20A	04 - 2.4~5.5V 12 - 4.5~14V	S - Single	0A0 - Programmable	S - SMD	03 - 3A 06 - 6A 12 - 12A 20 - 20A	N- negative P- positive	F- RoHS 6/6 (Lead Free)	A - Standard Function

MODEL LIST

Model Name	Packaging	Input Voltage	Output Voltage	Output Current	Efficiency 12V _{in} , 5V _{dc} @ 12A
DCM12S0A0S12NFA	SMD	4.5V ~ 14Vdc	0.69V~ 5.0Vdc	12A	95.4%

CONTACT: www.deltaww.com/dcdc

USA:

Telephone:
East Coast: 978-656-3993
West Coast: 510-668-5100
Fax: (978) 656 3964
Email: DCDC@delta-corp.com

Europe:

Telephone: +31-20-655-0967
Fax: +31-20-655-0999
Email: DCDC@delta-es.com

Asia & the rest of world:

Telephone: +886 3 4526107 x6220~6224
Fax: +886 3 4513485
Email: DCDC@delta.com.tw

WARRANTY

Delta offers a two (2) year limited warranty. Complete warranty information is listed on our web site or is available upon request from Delta.

Information furnished by Delta is believed to be accurate and reliable. However, no responsibility is assumed by Delta for its use, nor for any infringements of patents or other rights of third parties, which may result from its use. No license is granted by implication or otherwise under any patent or patent rights of Delta. Delta reserves the right to revise these specifications at any time, without notice.

Mouser Electronics

Authorized Distributor

Click to View Pricing, Inventory, Delivery & Lifecycle Information:

[Delta Electronics:](#)

[DCM12S0A0S12NFA](#)