

Actuator

45-
2630.2AE0.000



<https://eao.com/p/45-2630.2AE0.000>

Your product:



45-2630.2AE0.000 Actuator

FRONT

Front dimension:	Ø 60 mm
Front form:	round
Front bezel colour:	Silver
Front bezel material:	Metal

MOUNTING

Design:	raised
Mounting cut-out:	Ø 22.3 mm
Mounting type:	Panel mounting

OPERATING-/INDICATION PART

Lens colour:	Red
Lens material:	Plastic
Lens illumination:	illuminative
Lens shape:	mushroom-head
Lens optics:	transparent

MECHANICAL CHARACTERISTIC

Switching action:	Maintained
Switching system:	Slow-make switching element
Release type:	Pull unlock
Mechanical lifetime:	500 000 cycles of operation

Operating frequency: Max. 1 800/h

Weight: 0.067 kg

AMBIENT CONDITION

IP front protection: IP66, IP67, IP69K

Operating temperature: - 25 °C ... + 70 °C

Storage temperature: - 40 °C ... + 80 °C

Shock resistance: According to IEC 60068-2-27: Sinusoidal half-wave 50 g / 11 ms

Vibration resistance: According to IEC 60068-2-6: 20 ... 500 Hz: 5 g

Climate resistance: During operation according to IEC 60721: 3K6, 3C3, 3S2, 3M6

CERTIFICATE

REACH: REACH compliant

RoHS: RoHS compliant

OTHER

Short Description: Actuator, Ø 22.3 mm, Ø 60 mm, mushroom-head, illuminative, Red, Plastic, transparent, round, Silver, Metal, Maintained, IP66, IP67, IP69K, Pull unlock

Housing colour: Silver

Housing material: Metal

Wiring diagrams:

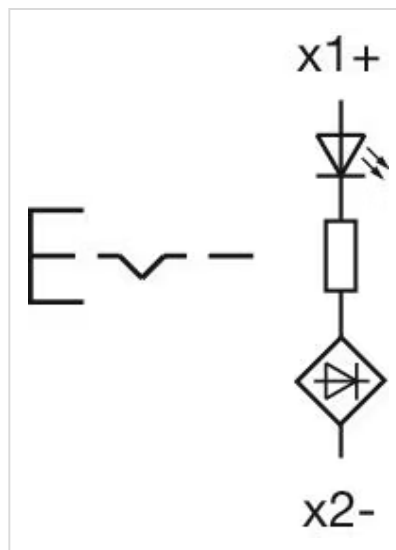



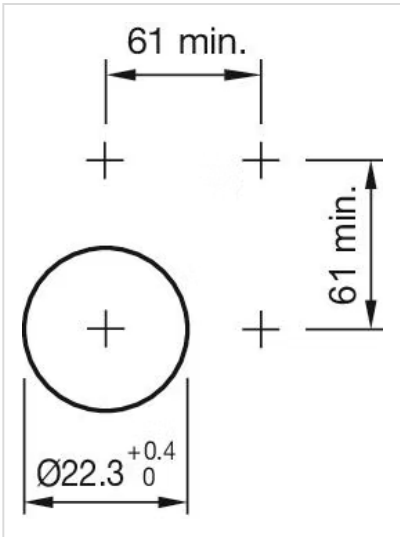



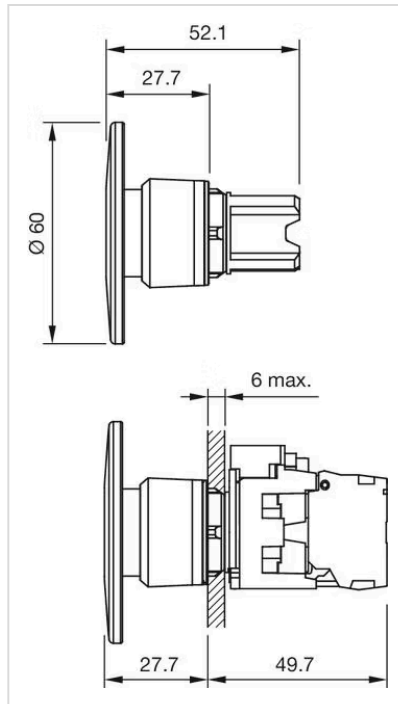



Mounting cut-outs:



Dimension drawings:



Where to Buy

	Distributor	Quantity in Stock	
	Digi-Key	10 in stock	Buy 
	Mouser Electronics	1 in stock	Buy 
	RS Americas	0 in stock	Buy 
	Newark Electronics	0 in stock	Buy 
	Sager	0 in stock	Buy 

Powered by oemsecrets.com

Mouser Electronics

Authorized Distributor

Click to View Pricing, Inventory, Delivery & Lifecycle Information:

[EAO:](#)

[45-2630.2AE0.000](#)