

SERIES 96
Conductive Rubber

FEATURES

- Quality, Economical Keyboards
- Easily Customized Legends
- Matrix Circuitry
- Backlit and Shielded Options Available
- Termination Mates With Standard Connectors
- Tactile Feedback to Operator
- 1,000,000 Operations per Button
- Compatible With High Resistance Logic Inputs

The Series 96 is Grayhill's most economical 3x4 and 4x4 keypad family. The contact system utilizes conductive rubber to mate the appropriate PC board traces. Offered in matrix circuitry, with shielded and backlit options. Built with quality component parts, the Series 96 is subjected to our rigid statistical process control to insure that it meets our reliability standards.

DIMENSIONS In inches (and millimeters)

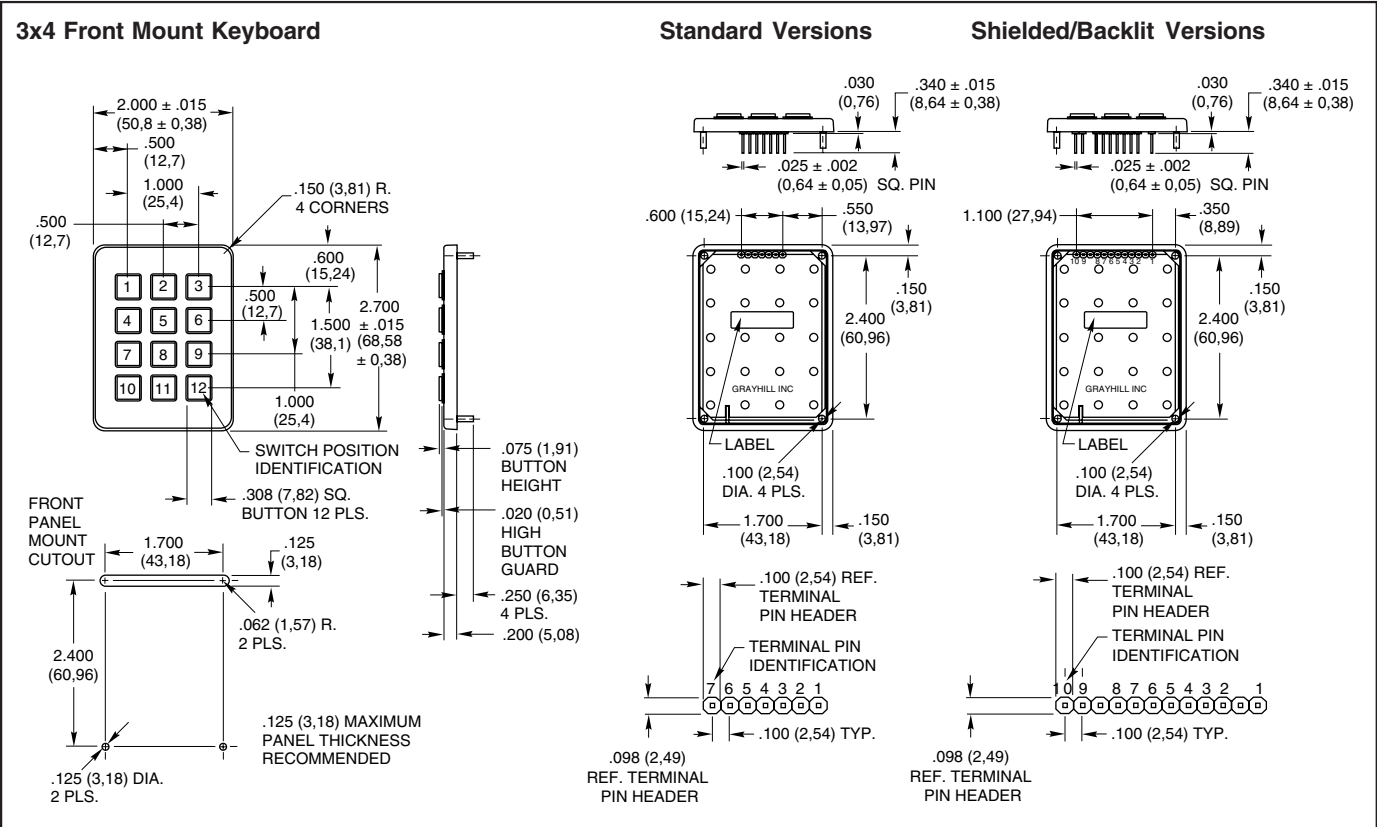

Keyboards and Keypads

DIMENSIONS In inches (and millimeters)

Keyboards and Keypads

3x4 Rear Mount Keyboard

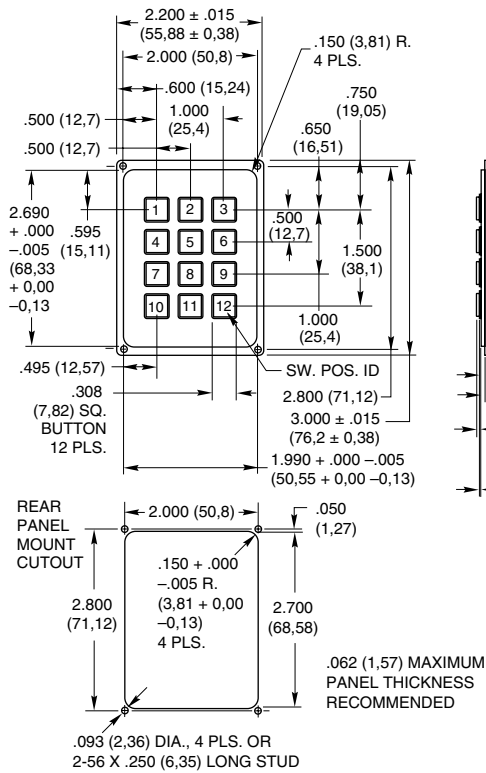

Standard Versions

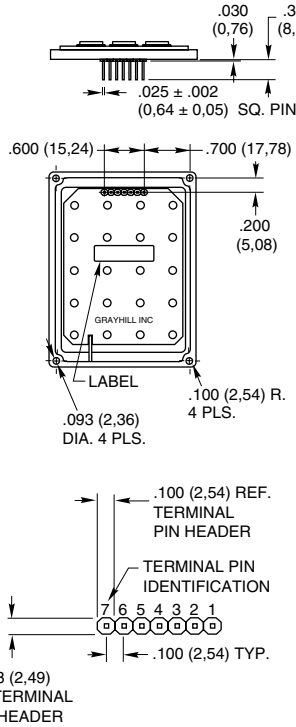

Shielded/Backlit Versions

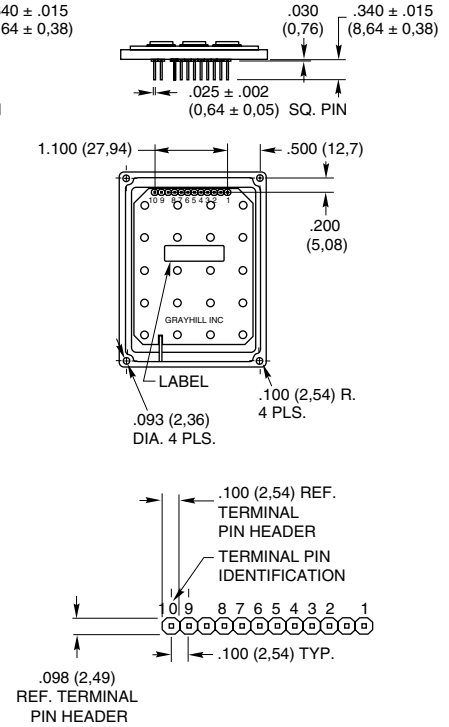

4x4 Front Mount Keyboard

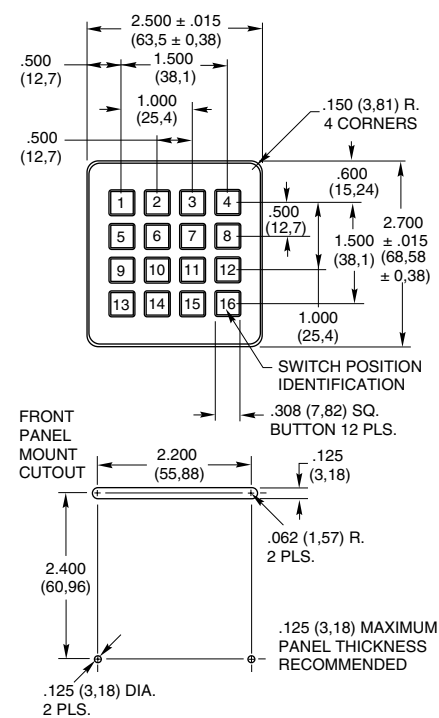

Standard Versions

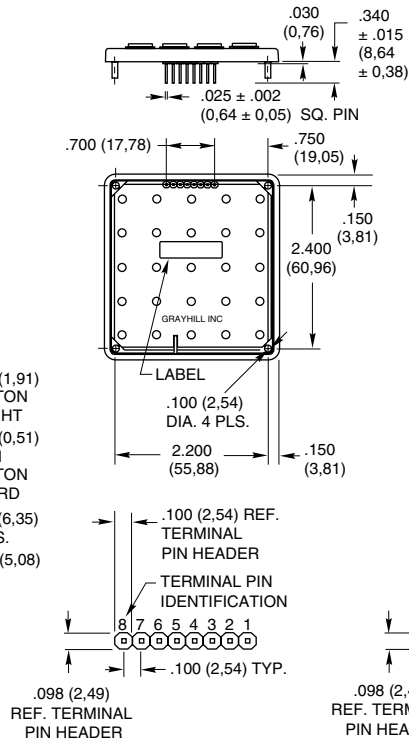

Shielded/Backlit Versions

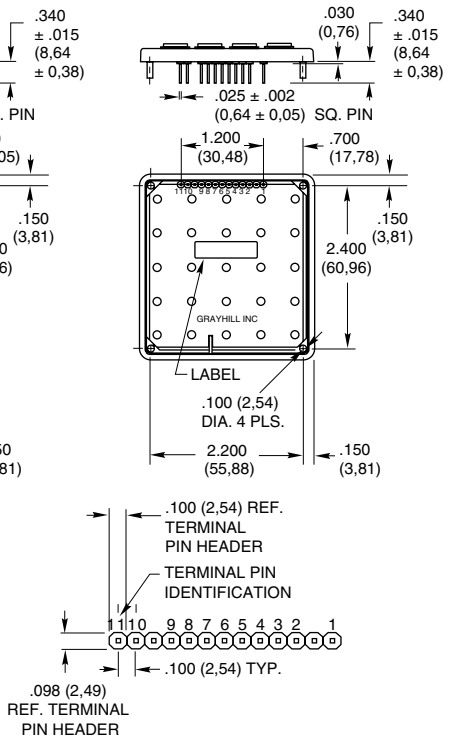

DIMENSIONS In inches (and millimeters)

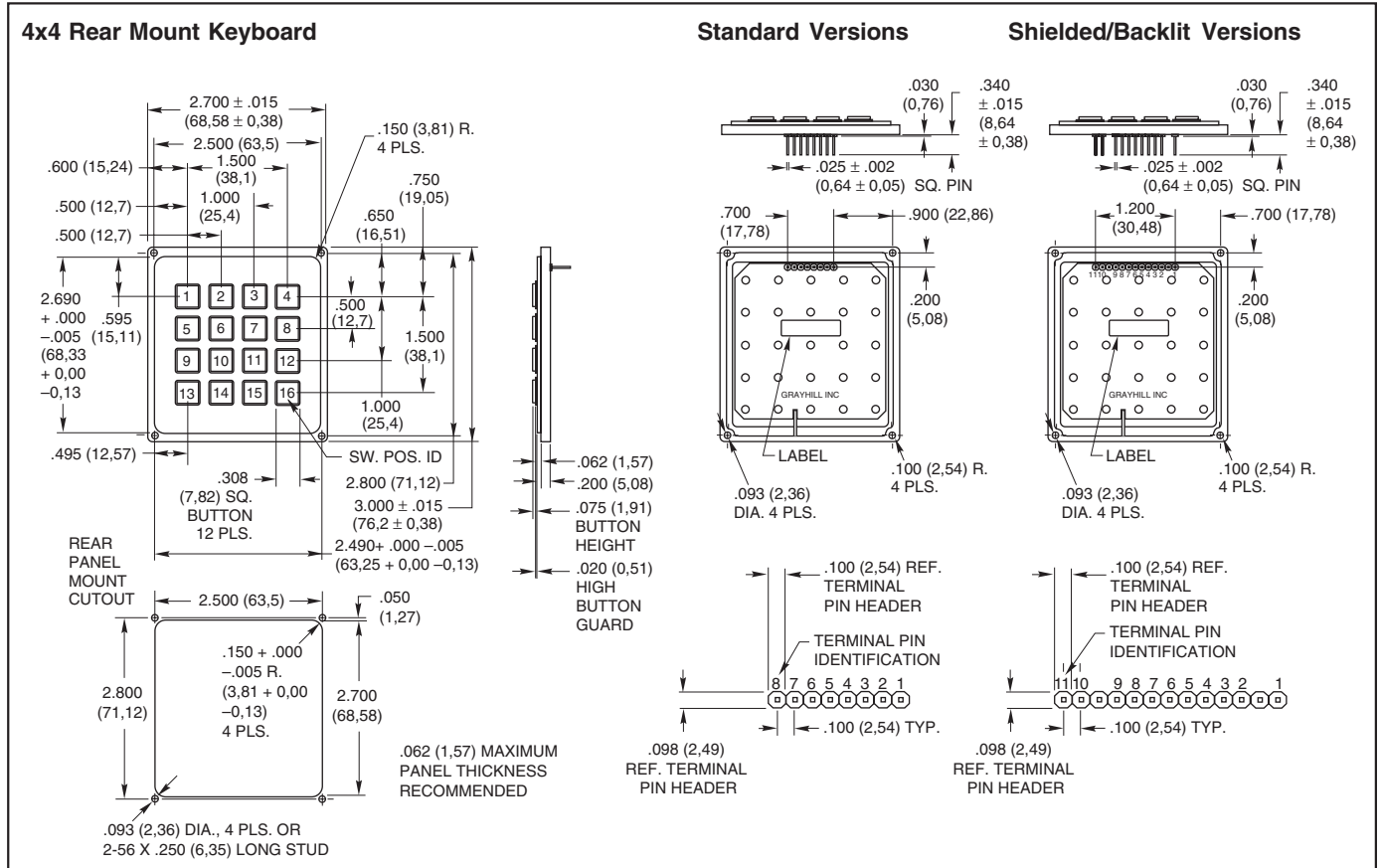

Keyboards and Keypads

CODE AND TRUTH TABLES

Dots in the chart indicate connected terminals when switch is closed. Terminals are identified on the keyboard.

12 Button Keypads

| | | MATRIX CODES | | | | | | | | | | | | | | | | | |
|-----------------|----|-------------------|---|---|---|------------------|---|---|---|---|---|---|---|---|---|---|---|----|--|
| | | Standard | | | | Shielded/Backlit | | | | | | | | | | | | | |
| BUTTON LOCATION | 1 | • | • | • | • | • | • | • | • | • | • | • | • | | | | | | |
| | 2 | • | • | • | • | • | • | • | • | • | • | • | • | | | | | | |
| | 3 | • | • | • | • | • | • | • | • | • | • | • | • | | | | | | |
| | 4 | • | • | • | • | • | • | • | • | • | • | • | • | | | | | | |
| | 5 | • | • | • | • | • | • | • | • | • | • | • | • | | | | | | |
| | 6 | • | • | • | • | • | • | • | • | • | • | • | • | | | | | | |
| | 7 | • | • | • | • | • | • | • | • | • | • | • | • | | | | | | |
| | 8 | • | • | • | • | • | • | • | • | • | • | • | • | | | | | | |
| | 9 | • | • | • | • | • | • | • | • | • | • | • | • | | | | | | |
| | 10 | • | • | • | • | • | • | • | • | • | • | • | • | | | | | | |
| | 11 | • | • | • | • | • | • | • | • | • | • | • | • | | | | | | |
| | 12 | • | • | • | • | • | • | • | • | • | • | • | • | | | | | | |
| | | 5 | 6 | 7 | 1 | 2 | 3 | 4 | 6 | 7 | 8 | 2 | 3 | 4 | 5 | 1 | 9 | 10 | |
| | | TERMINAL LOCATION | | | | | | | | | | | | | | | | | |

Shielded keypad = Shielded
Backlit keypad = NC
Shielded and backlit keypad = Shielded

Shielded keypad = NC
Backlit keypad = EL Panel 1
Shielded and backlit keypad = EL Panel 1

Shielded keypad = NC
Backlit keypad = EL Panel 2
Shielded and backlit keypad = EL Panel 2

16 Button Keypads

| | | MATRIX CODES | | | | | | | | | | | | | | | | | | | |
|-----------------|----|-------------------|---|---|---|------------------|---|---|---|---|---|---|---|---|---|---|---|---|----|----|--|
| | | Standard | | | | Shielded/Backlit | | | | | | | | | | | | | | | |
| BUTTON LOCATION | 1 | • | • | • | • | • | • | • | • | • | • | • | • | • | • | • | | | | | |
| | 2 | • | • | • | • | • | • | • | • | • | • | • | • | • | • | • | | | | | |
| | 3 | • | • | • | • | • | • | • | • | • | • | • | • | • | • | • | | | | | |
| | 4 | • | • | • | • | • | • | • | • | • | • | • | • | • | • | • | | | | | |
| | 5 | • | • | • | • | • | • | • | • | • | • | • | • | • | • | • | | | | | |
| | 6 | • | • | • | • | • | • | • | • | • | • | • | • | • | • | • | | | | | |
| | 7 | • | • | • | • | • | • | • | • | • | • | • | • | • | • | • | | | | | |
| | 8 | • | • | • | • | • | • | • | • | • | • | • | • | • | • | • | | | | | |
| | 9 | • | • | • | • | • | • | • | • | • | • | • | • | • | • | • | | | | | |
| | 10 | • | • | • | • | • | • | • | • | • | • | • | • | • | • | • | | | | | |
| | 11 | • | • | • | • | • | • | • | • | • | • | • | • | • | • | • | | | | | |
| | 12 | • | • | • | • | • | • | • | • | • | • | • | • | • | • | • | | | | | |
| | 13 | • | • | • | • | • | • | • | • | • | • | • | • | • | • | • | | | | | |
| | 14 | • | • | • | • | • | • | • | • | • | • | • | • | • | • | • | | | | | |
| | 15 | • | • | • | • | • | • | • | • | • | • | • | • | • | • | • | | | | | |
| | 16 | • | • | • | • | • | • | • | • | • | • | • | • | • | • | • | | | | | |
| | | 5 | 6 | 7 | 8 | 1 | 2 | 3 | 4 | 6 | 7 | 8 | 9 | 2 | 3 | 4 | 5 | 1 | 10 | 11 | |
| | | TERMINAL LOCATION | | | | | | | | | | | | | | | | | | | |

Shielded keypad = Shielded
Backlit keypad = NC
Shielded and backlit keypad = Shielded

Shielded keypad = NC
Backlit keypad = EL Panel 1
Shielded and backlit keypad = EL Panel 1

Shielded keypad = NC
Backlit keypad = EL Panel 2
Shielded and backlit keypad = EL Panel 2

SPECIFICATIONS

Rating Criteria

- Rating at 12 Vdc:** 5 milliamps for .5 seconds
- Contact Bounce:** < 12 milliseconds
- Contact Resistance:** < 300 milliohms max.
- Voltage Breakdown:** 250 Vac between components
- Mechanical Operation Life:** 1,000,000 operations per key
- Insulation Resistance:** > 10¹² ohms @ 500 Vdc
- Push Out Force Per Pin:** 5 lbs.

Operating Features

- Travel:** .040 minimum
- Operating Force:** 175 ± 40 grams
- Operating Temperature:** -30°C to +80°C

Material and Finishes

- Terminal Pin:** Phosphor bronze
- PC Board:** FR-4 glass cloth epoxy
- Keypad:** Silicone rubber, durometer 50 ± 5
- Housing:** ABS, cycolac FR15
- Housing Color:** Black

Shielding Effectiveness

Results shown are typical for a standard Grayhill Series 84S keyboard. A conductive gasket will generally increase the shielding, depending on the size and shape of the gasket and its material. Data derived for E-Field Radiation.

Test Method:

Measurements were made with the keyboard mounted to a brass plate, which in turn was mounted to a shielded enclosure containing the receiving equipment. A signal generator provided the frequency source that was radiated from the transmitting antenna to the enclosed receiving antenna. The spacing between antennas was maintained constant throughout the frequency range. The effectiveness rating is determined by establishing a reference reading without obstruction between the two antennas and determining the difference between that reading and the test setup reading.

Note:

When measured in actual equipment, shielding effectiveness is determined by many factors. This method accurately represents the shielding effectiveness of the Grayhill Series 84S under Ideal test conditions.

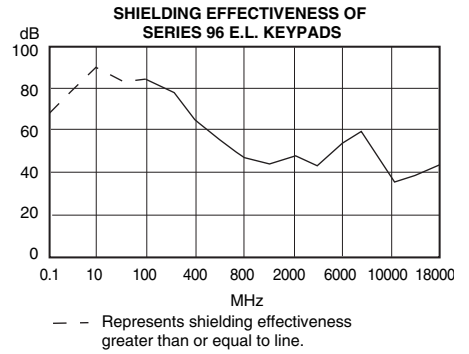

| Frequency M Hz | Rating in dB |
|-------------------|-----------------|
| 0.1 | ≥ 66.2 |
| 10 | ≥ 94.8 |
| 100 | 90.5 |
| 400 | 64.2 |
| 800 | 42.3 |
| 2,000 | 40.5 |
| 6,000 | 33.1 |
| 10,000 | 34.4 |
| 18,000 | 37.0 |

STANDARD LEGENDS

Available through Grayhill Distributors

To order one of the configurations below, use the dash number shown here; select the keypad size and code, and order the part number with the appropriate legend dash number.

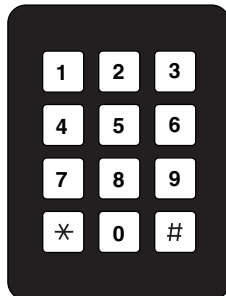

-102

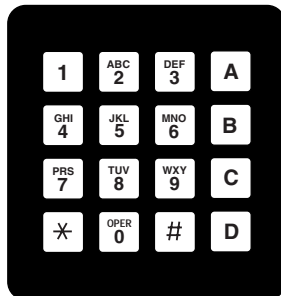

-006

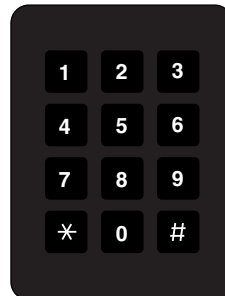

-152

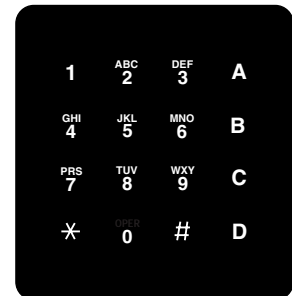

-056

ORDERING INFORMATION

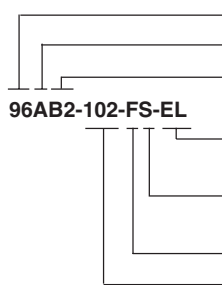

Grayhill Series Number

Keyboard Size: A = 3x4, B = 4x4

Circuitry: B2 = Matrix (terminal pin header)

96AB2-102-FS-EL

E.L. Panel Backlighting Option

EL = Backlit, Blank = Non-backlit

EMI/RFI Shielding Option

S = Shielded, Blank = Non-shielded

Mounting Option: F = Front panel mount, R = Rear panel mount

Standard Legend Choices

12 Position legends

102 = Black legends on a white button

152 = White legends on a black button

16 Position legends

006 = Black legends on a white button

056 = White legends on a black button

Available from your local Grayhill Distributor.

For prices and discounts, contact a local Sales Office, an authorized local Distributor or Grayhill.

Mouser Electronics

Authorized Distributor

Click to View Pricing, Inventory, Delivery & Lifecycle Information:

Grayhill:

[96BB2-002-F](#) [96BB2-008-F](#) [96BC2-056-R](#) [96BC2-006-F](#)