

SERIES 68A

Hall Effect Encoder

FEATURES

- Quadrature output - (push / pull type)
- Debris resistant hall effect sensor technology
- Over 1 million rotational cycles
- Optional integrated pushbutton
- Low power consumption
- Reverse voltage protection
- Choice of cable lengths and termination
- Available in 5Vdc and 3.3Vdc
- High torque version available

APPLICATIONS

- Medical Equipment
- Test & Measurement
- Audio / Visual
- Agriculture & Construction Vehicles

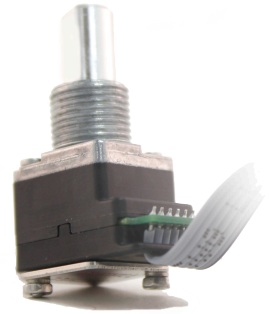

DIMENSIONS in inches (and millimeters)

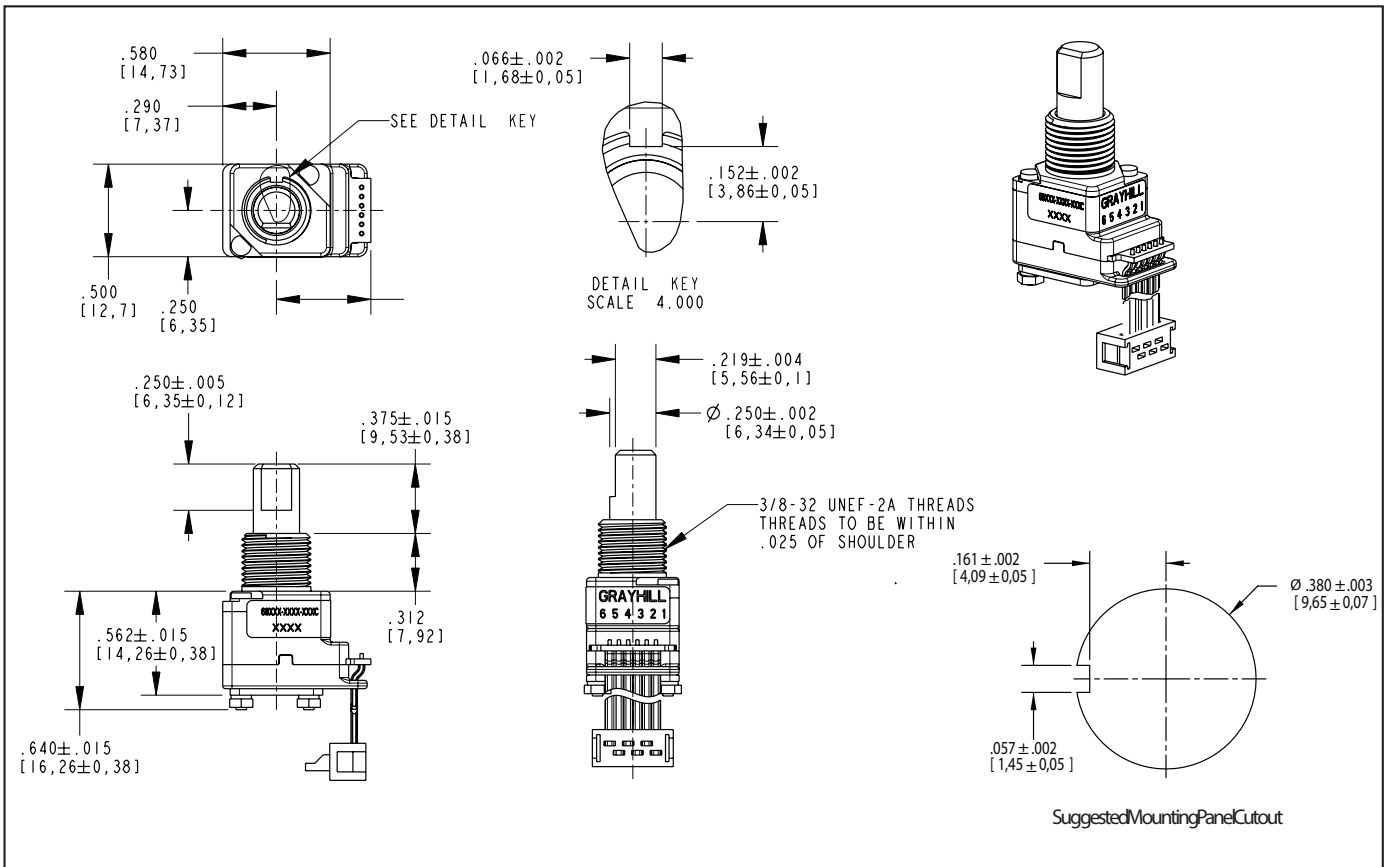

TERMINATION OPTIONS

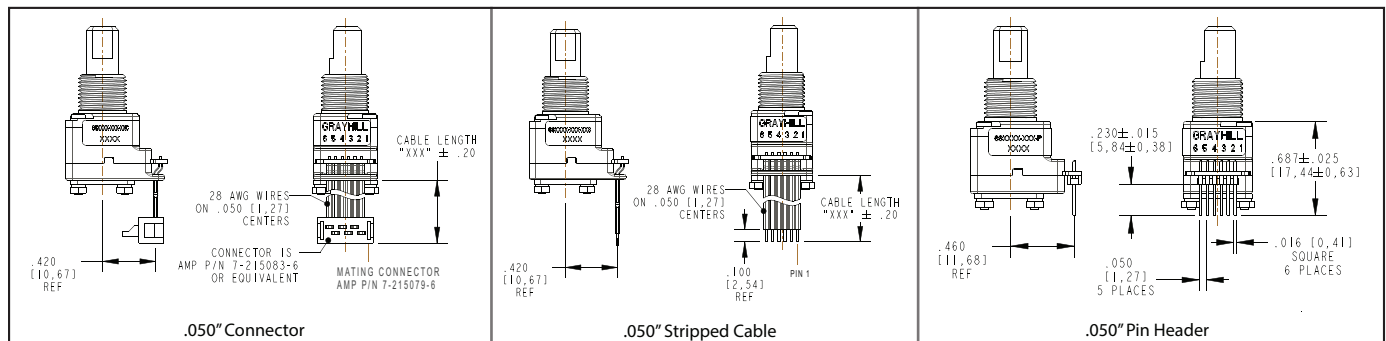

SCHEMATICS, WAVEFORM, AND TRUTH TABLE

FIG. 1 - 68A ELECTRICAL CONNECTION DIAGRAM

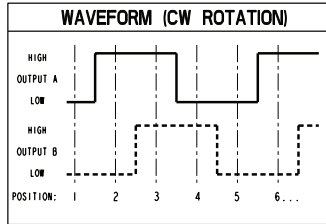
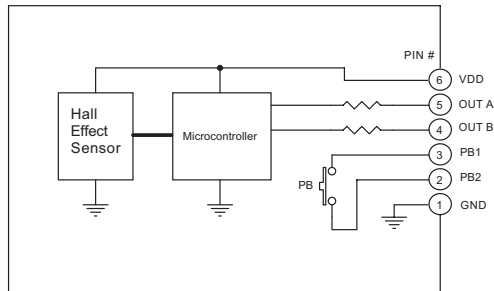

POSITION	OUTPUT A	OUTPUT B
1		
2	○	
3	○	○
4		○

BLANK = LOGIC LOW ○ = LOGIC HIGH
CODE REPEATS EVERY FOUR POSITIONS.

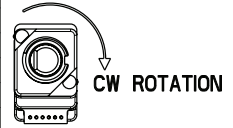

*Customized electrical outputs are available. Contact Grayhill for additional details.

SPECIFICATIONS

Electrical Specifications

Operating Voltage: Minimum 3.0 V, maximum 3.6 V (3.3V Style); minimum 4.5 V, maximum 5.5 V (5V Style)

Absolute Maximum Voltage* on VDD pin: -4.0 V min., +4.0 V max (3.3V style); -6.5 V min., +6.5 V max (5V style)

Avg Supply Current for 3.3V Style: Typical: 1.2 mA, Maximum: 2.0 mA (at 3.30 V)

Peak Supply Current for 3.3V Style: 12 mA (at 3.30 V)

Avg Supply Current for 5V Style: Typical: 1.8 mA, Maximum: 3.0mA (at 5.00 V)

Peak Supply Current for 5.0V Style: 12 mA (at 5.00 V)

Output Low Voltage: 0.6V maximum for IOL = 3mA, VDD = 3.3V and for IOL = 3mA, VDD = 5.0V

Output High Voltage: 2.6V minimum for IOH = -1.5mA, VDD = 3.3V, 4.3V minimum for IOH = -2mA, VDD = 5.0V

Power-Up Time: A & B outputs valid 120 ms (max) after VDD reaches 3.0 V (3.3 V Style) or 4.5 V (5V Style).

Soldering Recommendation

Hand solder only per IPC J-STD-001

Mechanical Specifications

Mechanical Life: 1,000,000 cycles of operation. 1 cycle is a rotation through all positions and a full return

Average Rotational Torque:

Low Detent = 2.0±1.4 in-oz initially

High = 3.5±1.4 in-oz initially

40% of initial value after 1 million cycles

Non-Detented: 1.5 in-oz maximum

Maximum rotational speed: 100 rpm

Mounting Torque: 15in-lbs. maximum

Shaft Pushout / Pullout Force: 45 lbs. / 45 lbs. minimum

Terminal Strength: 15 lbs. minimum. Cable or Header pullout force, MIL-STD-202, Method 211A, Test Condition A

Solderability: 95% free of pin holes & voids, MIL-STD-202, Method 208

Environmental Specifications

Operating Temperature: -40°C to 85°C, IEC 68-2-1, Test Aa and IEC 68-2-2, Test Aa

Storage Temperature: -55°C to 85°C, IEC 68-2-1, Method Aa and IEC 68-2-2, Method Ba

Humidity: 96 hours @ 90-95% humidity @ 40°C, MIL-STD-202, Method 103B

Mechanical Vibration: Harmonic motion with amplitude of 15g within a varied frequency of 10 to 2000 Hz for 12 hours, MIL-STD-202, Method 204, Test Condition B

Mechanical Shock:

Test 1: 100g for 6 ms half-sine wave with a velocity change of 12.3 ft/s.

Test 2: 100g for 6 ms sawtooth wave with a velocity change of 9.7 ft/s, MIL-STD-202, Method 213, Test Condition C and I

Seal: IP67, Meets IEC 60529

Pushbutton Electrical and Mechanical Specifications

Electrical Ratings: 6.0 V max, 10 mA, Resistive

Absolute Maximum Voltage* on Pins 2 & 3: 6.0 V

Contact Resistance: <10 Ω

Contact Bounce: <4 mS make, <10mS break

Actuation Force:

Sealed = 1350 ± 300g

Unsealed = 1150 ± 300g

Pushbutton Travel: .016 ± .008in

Pushbutton Life Expectancy: 1 million actuations minimum

Materials and Finishes

Bushing: Zinc

Shaft: Aluminum

Lockwasher: Spring steel, zinc plate with clear trivalent chromate finish

Cable: Copper stranded with topcoat in PVC insulation (Cable version only), 28 AWG

Header Pins: Tin plated phosphor bronze

Hex Nut: Nickel plated brass

ROHS Compliant.

EMC Ratings

Radiated Immunity: Meets ANSI/ASAE EP455 5.16 (100 V/m, 0.014-1000 MHz, 3 orientations)

Conducted Immunity: Meets IEC 61000-4-6, Level 3

Radiated Emissions: Meets ISO 14982, Sec 6.4 (Broadband), Sec 6.5 (Narrowband) limits

Conducted Emissions: Meets CISPR 25, Class 3

Electrostatic Discharge: Meets ANSI/ASAE EP455 5.12, surface: 25KV, connector: 15KV

Power Frequency Magnetic Field: Meets IEC 61000-4-8, 100 V/m

* Exceeding the Absolute Maximum Voltage may result in permanent damage to the device. This is a stress rating only and functional operation of the device at those or any other conditions above those indicated in the operation listings of this specification is not implied.

ORDERING INFORMATION

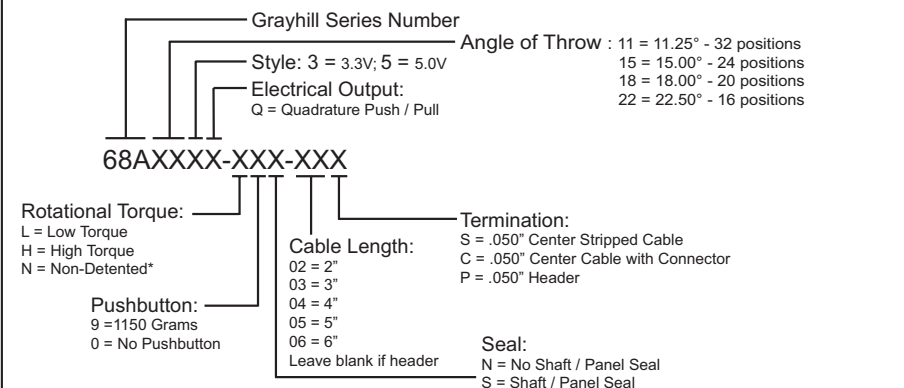

* Grayhill recommends the use of a shaft seal for non-detented encoders to prevent inadvertent code output changes due to the lack of detent.

For prices and custom configurations, contact a local sales office, an authorized distributor, or Grayhill's sales department.

MOUNTING PANEL RECOMMENDATIONS FOR PANEL SEAL VERSION:

1. Panel thickness should not exceed 0.157".
2. Mounting hole diameter to be per recommended dimensions.
3. 0.470" X 0.020" counter bore required for proper sealing.
4. Anti-rotation feature is recommended. Feature should be designed to lock into bushing keyway.

Mouser Electronics

Authorized Distributor

Click to View Pricing, Inventory, Delivery & Lifecycle Information:

Grayhill:

[68A225C-L9S-02C](#) [68A223C-L9N-02C](#) [68A225C-L9N-02C](#) [68A225P-L9N-02C](#) [68A225P-L9S-02C](#) [68A223P-L9S-02C](#) [68A223C-L9S-02C](#) [68A223P-L9N-02C](#) [68A225Q-L9S-02C](#) [68A225Q-L9N-06C](#) [68A225Q-H9S-06C](#) [68A115Q-L9N-06C](#) [68A115Q-H9S-06C](#) [68A225Q-H0S-02C](#) [68A225Q-H9S-02C](#) [68A225Q-L0S-02C](#) [68A113Q-L9S-P](#)
[68A225Q-H9S-04S](#)