



Arria II GX FPGA Development Kit

User Guide



101 Innovation Drive
San Jose, CA 95134
www.altera.com

UG-01066-1.1



Subscribe

Copyright © 2011 Altera Corporation. All rights reserved. Altera, The Programmable Solutions Company, the stylized Altera logo, and specific device designations are trademarks and/or service marks of Altera Corporation in the U.S. and other countries. All other words and logos identified as trademarks and/or service marks are the property of Altera Corporation or their respective owners. Altera products are protected under numerous U.S. and foreign patents and pending applications, maskwork rights, and copyrights. Altera warrants performance of its semiconductor products to current specifications in accordance with Altera's standard warranty, but reserves the right to make changes to any products and services at any time without notice. Altera assumes no responsibility or liability arising out of the application or use of any information, product, or service described herein except as expressly agreed to in writing by Altera. Altera customers are advised to obtain the latest version of device specifications before relying on any published information and before placing orders for products or services.



Chapter 1. About This Kit

Kit Features	1-1
Hardware	1-1
Software	1-1
Quartus II Subscription Edition Software	1-2
Arria II GX FPGA Development Kit Installer	1-2

Chapter 2. Getting Started

Before You Begin	2-1
Inspect the Board	2-1
References	2-2

Chapter 3. Software Installation

Installing the Quartus II Subscription Edition Software	3-1
Licensing Considerations	3-1
Installing the Arria II GX FPGA Development Kit	3-2
Installing the USB-Blaster Driver	3-3

Chapter 4. Development Board Setup

Setting Up the Board	4-1
Factory Default Switch Settings	4-2

Chapter 5. Board Update Portal

Connecting to the Board Update Portal Web Page	5-1
Using the Board Update Portal to Update User Designs	5-2

Chapter 6. Board Test System

Preparing the Board	6-3
Running the Board Test System	6-3
Using the Board Test System	6-4
The Configure Menu	6-4
The Config Tab	6-4
MAX II Registers	6-5
JTAG Chain	6-6
Board Information	6-6
Flash Memory Map	6-6
The GPIO Tab	6-7
LCD	6-7
User Dipswitch	6-7
User LEDs	6-8
Pushbutton Switches	6-8
The Flash Tab	6-8
Read	6-9
Write	6-9
Random Test	6-9
CFI Query	6-9
Increment Test	6-9
Reset	6-9

Erase	6-9
Flash Memory Map	6-9
The SSRAM Tab	6-10
Read	6-10
Write	6-11
Random Test	6-11
Increment Test	6-11
The DDR3 Tab	6-11
Start	6-12
Stop	6-12
Performance Indicators	6-12
Error Control	6-12
Number of Addresses to Write/Read	6-12
Data Type	6-12
W/R Control	6-13
The DDR2 Tab	6-13
Start	6-14
Stop	6-14
Performance Indicators	6-14
Error Control	6-14
Number of Addresses to Write/Read	6-14
Data Type	6-14
W/R Control	6-15
The HSMC Tab	6-15
Status	6-16
Port	6-16
PMA Setting	6-16
Data Type	6-16
Error Control	6-17
Start	6-17
Stop	6-17
Performance Indicators	6-17
The Power Monitor	6-18
General Information	6-19
Power Information	6-19
Power Graph	6-19
Graph Settings	6-19
Reset	6-19
Calculating Power	6-20
Configuring the FPGA Using the Quartus II Programmer	6-20

Appendix A. Programming the Flash Memory Device

CFI Flash Memory Map	A-1
Preparing Design Files for Flash Programming	A-2
Creating Flash Files Using the Nios II EDS	A-2
Programming Flash Memory Using the Board Update Portal	A-3
Programming Flash Memory Using the Nios II EDS	A-3
Restoring the Flash Device to the Factory Settings	A-4
Restoring the MAX II CPLD to the Factory Settings	A-5

Additional Information

Document Revision History	Info-1
How to Contact Altera	Info-1

Typographic Conventions Info-1

The Altera® Arria® II GX FPGA Development Kit is a complete design environment that includes both the hardware and software you need to develop Arria II GX FPGA designs. The PCI-SIG-compliant board and the one-year license for the Quartus® II software provide everything you need to begin developing custom Arria II GX FPGA designs. The following list describes what you can accomplish with the kit:

- Develop and test PCI Express® (PCIe) designs.
- Develop and test memory subsystems consisting of DDR2 and DDR3 memories.
- Take advantage of the modular and scalable design by using the high-speed mezzanine card (HSMC) connectors to interface to over 30 different HSMCs provided by Altera partners, supporting protocols such as Serial RapidIO®, 10 Gigabit Ethernet, SONET, Common Public Radio Interface (CPRI), Open Base Station Architecture Initiative (OBSAI) and others.

Kit Features

This section briefly describes the Arria II GX FPGA Development Kit contents.

Hardware

The Arria II GX FPGA Development Kit includes the following hardware:

- Arria II GX FPGA development board—A development platform that allows you to develop and prototype hardware designs running on the Arria II GX EP2AGX125 FPGA.

 For detailed information about the board components and interfaces, refer to the *Arria II GX FPGA Development Board Reference Manual*.

- Power supply and cables—The kit includes the following items:
 - Power supply and AC adapters for North America/Japan, Europe, and the United Kingdom
 - USB cable
 - Ethernet cable
 - HSMC loopback board—A daughtercard that allows for loopback testing all signals on the HSMC interface using the Board Test System
 - HSMC debug breakout board—A daughtercard that routes 40 CMOS signals to a 0.1-inch header and adds 20 LEDs to the remaining 40 CMOS signals

Software

The software for this kit, described in the following sections, is available on the Altera website for immediate downloading. You can also request to have Altera mail the software to you on DVDs.

Quartus II Subscription Edition Software

The Quartus II Subscription Edition Software is a licensed set of Altera tools with full functionality. Your kit includes a one-year license for the Quartus II software (Windows platform only). This license entitles you to all the features of the subscription edition for a period of one year. After the year, you must purchase a renewal subscription to continue using the software. For more information, refer to the Altera website (www.altera.com).

 Download the Quartus II Subscription Edition Software from the [Quartus II Subscription Edition Software](#) page of the Altera website. Alternatively, you can request a DVD from the [Altera IP and Software DVD Request Form](#) page of the Altera website.

The Quartus II Subscription Edition Software includes the following items:

- Quartus II Software—The Quartus II software, including the SOPC Builder system development tool, provides a comprehensive environment for system-on-a-programmable-chip (SOPC) design. The Quartus II software integrates into nearly any design environment and provides interfaces to industry-standard EDA tools.
- MegaCore[®] IP Library—A library that contains Altera IP MegaCore functions. You can evaluate MegaCore functions by using the OpenCore Plus feature to do the following:
 - Simulate behavior of a MegaCore function within your system.
 - Verify functionality of your design, and quickly and easily evaluate its size and speed.
 - Generate time-limited device programming files for designs that include MegaCore functions.
 - Program a device and verify your design in hardware.

 The OpenCore Plus hardware evaluation feature is an evaluation tool for prototyping only. You must purchase a license to use a MegaCore function in production.

 For more information about OpenCore Plus, refer to *AN 320: OpenCore Plus Evaluation of Megafunctions*.

- Nios[®] II Embedded Design Suite (EDS)—A full-featured set of tools that allows you to develop embedded software for the Nios II processor which you can include in your Altera FPGA designs.

Arria II GX FPGA Development Kit Installer

The license-free Arria II GX FPGA Development Kit installer includes all the documentation and design examples for the kit.

Download the Arria II GX FPGA Development Kit installer from the [Arria II GX FPGA Development Kit](#) page of the Altera website. Alternatively, you can request a development kit DVD from the [Altera Kit Installations DVD Request Form](#) page of the Altera website.

The remaining chapters in this user guide lead you through the following Arria II GX FPGA development board setup steps:

- Inspecting the contents of the kit
- Installing the design and kit software
- Setting up, powering up, and verifying correct operation of the FPGA development board
- Configuring the Arria II GX FPGA
- Running the Board Test System designs

 For complete information about the FPGA development board, refer to the *Arria II GX FPGA Development Board Reference Manual*.

Before You Begin

Before using the kit or installing the software, check the kit contents and inspect the board to verify that you received all of the items listed in “Kit Features” on page 1–1. If any of the items are missing, contact Altera before you proceed.

Inspect the Board

To inspect the board, perform the following steps:

1. Place the board on an anti-static surface and inspect it to ensure that it has not been damaged during shipment.



Without proper anti-static handling, you can damage the board.

2. Verify that all components are on the board and appear intact.



In typical applications with the Arria II GX FPGA development board, a heat sink is not necessary. However, under extreme conditions or for engineering sample silicon the board might require additional cooling to stay within operating temperature guidelines. You can perform power consumption and thermal modeling to determine whether your application requires additional cooling. The board has two holes near the FPGA that accommodate many different heat sinks, including the Dynatron V31G.



For more information about power consumption and thermal modeling, refer to *AN 358: Thermal Management for FPGAs*.



To avoid damage to the board, always have the board POWER switch (SW1) in the OFF position before inserting the DC power jack (J4).

References

Use the following links to check the Altera website for other related information:

- For the latest board design files and reference designs, refer to the [Arria II GX FPGA Development Kit](#) page.
- For additional daughter cards available for purchase, refer to the [Development Board Daughtercards](#) page.
- For the Arria II GX device documentation, refer to the [Literature: Arria II GX Devices](#) page.
- To purchase devices from the eStore, refer to the [Devices](#) page.
- For Arria II GX OrCAD symbols, refer to the [Capture CIS Symbols](#) page.
- For Nios II 32-bit embedded processor solutions, refer to the [Embedded Processing](#) page.

This chapter explains how to install the following software:

- Quartus II Subscription Edition Software
- Arria II GX FPGA Development Kit
- USB-Blaster™ driver

Installing the Quartus II Subscription Edition Software

The Quartus II Subscription Edition Software provides the necessary tools used for developing hardware and software for Altera FPGAs. Included in the Quartus II Subscription Edition Software are the Quartus II software, the Nios II EDS, and the MegaCore IP Library. The Quartus II software (including SOPC Builder) and the Nios II EDS are the primary FPGA development tools used to create the reference designs in this kit. To install the Altera development tools, perform the following steps:

1. Run the Quartus II Subscription Edition Software installer you acquired in “Software” on page 1–1.
2. Follow the on-screen instructions to complete the installation process.

 If you have difficulty installing the Quartus II software, refer to *Altera Software Installation and Licensing Manual*.

Licensing Considerations

Purchasing this kit entitles you to a one-year license for the Quartus II Subscription Edition Software. Before using the Quartus II software, you must activate your license, identify specific users and computers, and obtain and install a license file.

If you already have a licensed version of the subscription edition, you can use that license file with this kit. If not, you need to obtain and install a license file. To begin, go to the [Self Service Licensing Center](#) page of the Altera website, log into or create your myAltera account, and take the following actions:

1. On the [Activate Products](#) page, enter the serial number provided with your development kit in the **License Activation Code** box.



 Your serial number is printed on the development kit box below the bottom bar code. The number is 10 or 11 alphanumeric characters and does not contain hyphens. [Figure 3-1](#) shows 3S150SPXXXX as an example serial number.

Figure 3-1. Locating Your Serial Number



2. Consult the Activate Products table, to determine how to proceed.
 - a. If the administrator listed for your product is someone other than you, skip the remaining steps and contact your administrator to become a licensed user.
 - b. If the administrator listed for your product is you, proceed to step 3.
 - c. If the administrator listed for your product is *Stocking*, activate the product, making you the administrator, and proceed to step 3.
3. Use the [Create New License](#) page to license your product for a specific user (you) on specific computers. The [Manage Computers](#) and [Manage Users](#) pages allow you to add users and computers not already present in the licensing system.

 To license the Quartus II software, you need your computer's network interface card (NIC) ID, a number that uniquely identifies your computer. On the computer you use to run the Quartus II software, type `ipconfig /all` at a command prompt to determine the NIC ID. Your NIC ID is the 12-digit hexadecimal number on the **Physical Address** line.

4. When licensing is complete, Altera emails a **license.dat** file to you. Store the file on your computer and use the **License Setup** page of the **Options** dialog box in the Quartus II software to enable the software.

 For complete licensing details, refer to [Altera Software Installation and Licensing Manual](#).

Installing the Arria II GX FPGA Development Kit

To install the Arria II GX FPGA Development Kit, perform the following steps:

1. Run the Arria II GX FPGA Development Kit installer you acquired in “[Software](#)” on page 1-1.

- Follow the on-screen instructions to complete the installation process. Be sure that the installation directory you choose is in the same relative location to the Quartus II software installation.

The installation program creates the Arria II GX FPGA Development Kit directory structure shown in Figure 3-2.

Figure 3-2. Arria II GX FPGA Development Kit Installed Directory Structure (1)

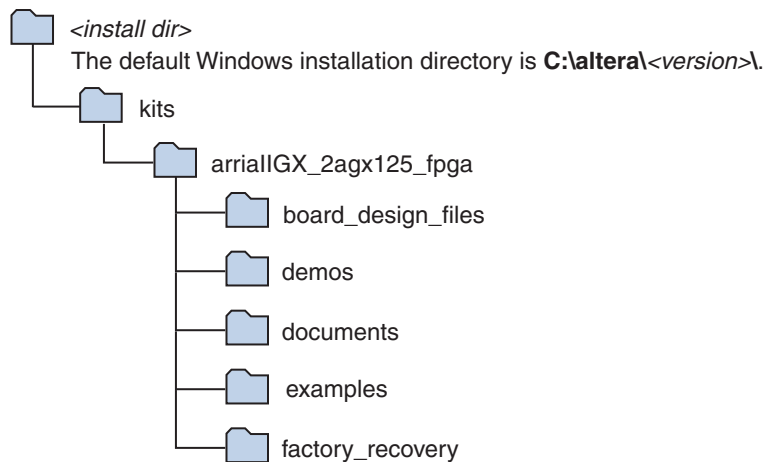

Note to Figure 3-2:

(1) Early-release versions might have slightly different directory names.

Table 3-1 lists the file directory names and a description of their contents.

Table 3-1. Installed Directory Contents

Directory Name	Description of Contents
board_design_files	Contains schematic, layout, assembly, and bill of material board design files. Use these files as a starting point for a new prototype board design.
demos	Contains demonstration applications.
documents	Contains the kit documentation.
examples	Contains the sample design files for the Arria II GX FPGA Development Kit.
factory_recovery	Contains the original data programmed onto the board before shipment. Use this data to restore the board with its original factory contents.

Installing the USB-Blaster Driver

The Arria II GX FPGA development board includes integrated USB-Blaster circuitry for FPGA programming. However, for the host computer and board to communicate, you must install the USB-Blaster driver on the host computer.

- Installation instructions for the USB-Blaster driver for your operating system are available on the Altera website. On the [Cable & Adapter Driver Information](#) page of the Altera website, locate the table entry for your configuration and click the link to access the instructions.

The instructions in this chapter explain how to set up the Arria II GX FPGA development board.

Setting Up the Board

To prepare and apply power to the board, perform the following steps:

1. The Arria II GX FPGA development board ships with its board switches preconfigured to support the design examples in the kit. If you suspect your board might not be currently configured with the default settings, follow the instructions in “Factory Default Switch Settings” on page 4–2 to return the board to its factory settings before proceeding.
2. The FPGA development board ships with design examples stored in the flash memory device. Verify the USER_LOAD switch (SW4.4) is set to the off position to load the design stored in the factory portion of flash memory. Figure 4–1 shows the switch location on the Arria II GX FPGA development board.
3. Set the POWER switch (SW1) to the off position.



To avoid damage to the board, always have the board POWER switch (SW1) in the off position before inserting the DC power jack (J4).

4. Connect the DC adapter (+16 V, 3.75 A) to the DC power jack (J4) on the FPGA board and plug the cord into a power outlet.



Use only the supplied 16-V power supply. Power regulation circuitry on the board can be damaged by power supplies with greater voltage.

5. Set the POWER switch (SW1) to the on position. When power is supplied to the board, a blue LED (D18) illuminates indicating that the board has power.

The MAX II device on the board contains a parallel flash loader (PFL) megafunction. When the board powers up, the PFL reads a design from flash memory and configures the FPGA. The USER_LOAD switch (SW4.4) controls which design to load. When the switch is in the off position, the PFL loads the design from the factory portion of flash memory. When the switch is in the on position, the PFL loads the design from the user portion of flash memory.



The kit includes a MAX II design which contains the MAX II PFL megafunction. The design resides in the `<install dir>\kits\arriaIIGX_2agx125_fpga\examples\max2` directory.

When configuration is complete, the CONF DONE LED (D14) illuminates, signaling that the Arria II GX device configured successfully.



For more information about the PFL megafunction, refer to *Parallel Flash Loader Megafunction User Guide*.

Factory Default Switch Settings

This section shows the factory switch settings for the Arria II GX FPGA development board. Figure 4-1 shows the switch locations and the default position of each switch.

Figure 4-1. Switch Locations and Default Settings on the FPGA Development Board

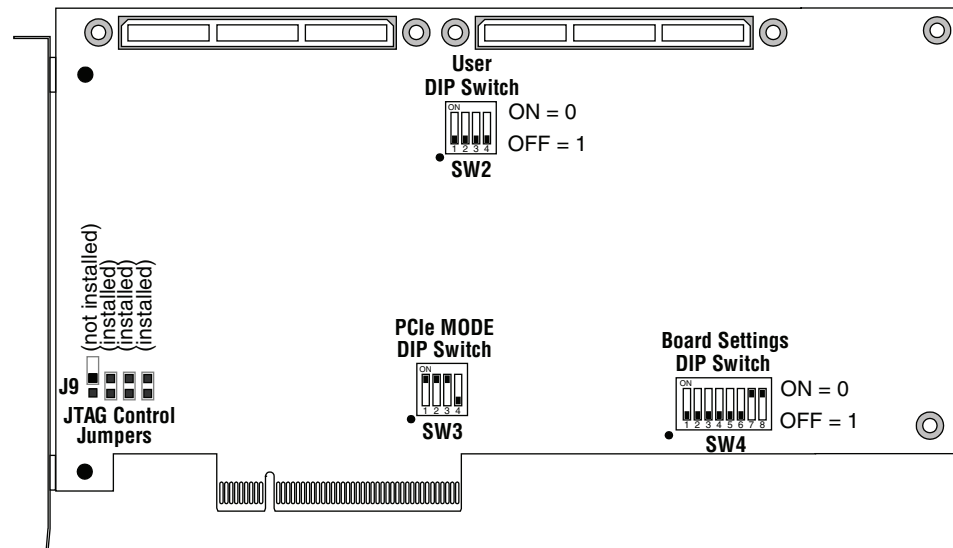

To restore the switches to their factory default settings, perform the following steps:

1. Set DIP switch bank (SW3) to match Table 4-1 and Figure 4-1.

Table 4-1. SW3 Dip Switch Settings

Switch	Board Label	Function	Default Position
1	PCIe x1	Switch 1 has the following options: <ul style="list-style-type: none"> ■ When off, the PCIe card PCIE_PRSENT2n_x1 signal is connected to PCIe card PRSNT1 signal. ■ When on, the PCIe card PCIE_PRSENT2n_x1 signal floats. 	On
2	PCIe x4	Switch 2 has the following options: <ul style="list-style-type: none"> ■ When off, the PCIe card PCIE_PRSENT2n_x4 signal is connected to PCIe card PRSNT1 signal. ■ When on, the PCIe card PCIE_PRSENT2n_x4 signal floats. 	On
3	PCIe x8	Switch 3 has the following options: <ul style="list-style-type: none"> ■ When off, the PCIe card PCIE_PRSENT2n_x8 signal is connected to PCIe card PRSNT1 signal. ■ When on, the PCIe card PCIE_PRSENT2n_x8 signal floats. 	On
4	—	■ —	—

2. Set DIP switch bank (SW4) to match Table 4–2 and Figure 4–1.

Table 4–2. SW4 Dip Switch Settings

Switch	Board Label	Function	Default Position
1	DIP0	Switch 1 has the following options: <ul style="list-style-type: none"> ■ When on, reserved. ■ When off, reserved. 	Off
2	DIP1	Switch 2 has the following options: <ul style="list-style-type: none"> ■ When on, reserved. ■ When off, reserved. 	Off
3	DIP2	Switch 3 has the following options: <ul style="list-style-type: none"> ■ When on, reserved. ■ When off, reserved. 	Off
4	USER LOAD	Switch 4 has the following options: <ul style="list-style-type: none"> ■ When on, the PFL loads the user hardware 1 design on power up. ■ When off, the PFL loads the factory design on power up. 	Off
5	PWR MON	Switch 5 has the following options: <ul style="list-style-type: none"> ■ When on, reserved. ■ When off, reserved. 	Off
6	USB DISn	Switch 6 has the following options: <ul style="list-style-type: none"> ■ When on, reserved. ■ When off, reserved. 	Off
7	CLK EN	Switch 7 has the following options: <ul style="list-style-type: none"> ■ When on, all on-board oscillators are enabled. ■ When off, on-board oscillators to the FPGA are disabled. 	On
8	CLK SEL	Switch 8 has the following options: <ul style="list-style-type: none"> ■ When on, programmable oscillator clock (U30) is selected. ■ When off, LVPECL SMA clock (J10 and J11) is selected. 	On

3. Set the board jumpers to match Table 4–3 and Figure 4–1.

Table 4–3. JTAG Chain Jumper Settings (Part 1 of 2)

Board Reference	Board Label	Function	Default Shunt Position
J9 pins 1-2	MAX DIS	This jumper has the following options: <ul style="list-style-type: none"> ■ Installing the shunt removes the MAX II EPM2210 device from the JTAG chain. ■ Removing the shunt includes the MAX II EPM2210 device in the JTAG chain. 	Not installed
J9 pins 3-4	HSMA DIS	This jumper has the following options: <ul style="list-style-type: none"> ■ Installing the shunt removes HSMC port A from the JTAG chain. ■ Removing the shunt includes HSMC port A in the JTAG chain. 	Installed

Table 4-3. JTAG Chain Jumper Settings (Part 2 of 2)

Board Reference	Board Label	Function	Default Shunt Position
J9 pins 5-6	HSMB DIS	This jumper has the following options: <ul style="list-style-type: none"> ■ Installing the shunt removes HSMC port B from the JTAG chain. ■ Removing the shunt includes HSMC port B in the JTAG chain. 	Installed
J9 pins 7-8	PCIe DIS	This jumper has the following options: <ul style="list-style-type: none"> ■ Installing the shunt removes the PCIe device from the JTAG chain. ■ Removing the shunt includes the PCIe device in the JTAG chain. 	Installed

For more information about the FPGA board settings, refer to the *Arria II GX FPGA Development Board Reference Manual*.

The Arria II GX FPGA Development Kit ships with the Board Update Portal design example stored in the factory portion of the flash memory on the board. The design consists of a Nios II embedded processor, an Ethernet MAC, and an HTML web server.

When you power up the board with the USER_LOAD switch (SW4.4) in the off position, the Arria II GX FPGA configures with the Board Update Portal design example. The design can obtain an IP address from any DHCP server and serve a web page from the flash on your board to any host computer on the same network. The web page allows you to upload new FPGA designs to the user hardware portion of flash memory, and provides links to useful information on the Altera website, including kit-specific links and design resources.



After successfully updating the user hardware flash memory, you can load the user design from flash memory into the FPGA. To do so, set the USER_LOAD switch (SW4.4) to the on position and power cycle the board.

The source code for the Board Update Portal design resides in the `<install dir>\kits\arriaIIGX_2agx125_fpga\examples` directory. If the Board Update Portal is corrupted or deleted from the flash memory, refer to “Restoring the Flash Device to the Factory Settings” on page A-4 to restore the board with its original factory contents.

Connecting to the Board Update Portal Web Page

This section provides instructions to connect to the Board Update Portal web page.



Before you proceed, ensure that you have the following:

- A PC with a connection to a working Ethernet port on a DHCP enabled network.
- A separate working Ethernet port connected to the same network for the board.
- The Ethernet and power cables that are included in the kit.

To connect to the Board Update Portal web page, perform these steps:

1. With the board powered down, set the USER_LOAD switch (SW4.4) to the off position.
2. Attach the Ethernet cable from the board to your LAN.
3. Power up the board. The board connects to the LAN’s gateway router, and obtains an IP address. The LCD on the board displays the IP address.
4. Launch a web browser on a PC that is connected to the same network, and enter the IP address from the LCD into the browser address bar. The Board Update Portal web page appears in the browser.

5. Click Arria II GX FPGA Development Kit on the Board Update Portal web page to access the kit's home page. Visit this page occasionally for documentation updates and additional new designs.

 You can also navigate directly to the [Arria II GX FPGA Development Kit](#) page of the Altera website to determine if you have the latest kit software.

Using the Board Update Portal to Update User Designs

The Board Update Portal allows you to write new designs to the user portion of flash memory. Designs must be in the Nios II Flash Programmer File (.flash) format.

 Design files available from the [Arria II GX FPGA Development Kit](#) page include .flash files. You can also create .flash files from your own custom design. Refer to “Preparing Design Files for Flash Programming” on page A-2 for information about preparing your own design for upload.

To upload a design over the network into the user portion of flash memory on your board, perform the following steps:

1. Perform the steps in “[Connecting to the Board Update Portal Web Page](#)” to access the Board Update Portal web page.
2. In the **Hardware File Name** field specify the .flash file that you either downloaded from the Altera website or created on your own. If there is a software component to the design, specify it in the same manner using the **Software File Name** field, otherwise leave the **Software File Name** field blank.
3. Click **Upload**. The progress bar indicates the percent complete.
4. To configure the FPGA with the new design after the flash memory upload process is complete, set the USER_LOAD switch (SW4.4) to the on position and power cycle the board, or press the IMAGE SEL button (PB6) until the CONFIG1 LED (D12) illuminates and then press the LOAD IMAGE button (PB5). Refer to [Table 6-1 on page 6-5](#) for information about the CONFIG LEDs.

 As long as you don't overwrite the factory image in the flash memory device, you can continue to use the Board Update Portal to write new designs to the user portion of flash memory. If you do overwrite the factory image, you can restore it by following the instructions in “[Restoring the Flash Device to the Factory Settings](#)” on page A-4.

The kit includes a design example and application called the Board Test System to test the functionality of the Arria II GX FPGA development board. The application provides an easy-to-use interface to alter functional settings and observe the results. You can use the application to test board components, modify functional parameters, observe performance, and measure power usage. The application is also useful as a reference for designing systems. To install the application, follow the steps in [“Installing the Arria II GX FPGA Development Kit”](#) on page 3–2.

The application provides access to the following Arria II GX FPGA development board features:

- General purpose I/O (GPIO)
- SRAM
- Flash memory
- DDR2 and DDR3 memories
- HSMC connectors
- Character LCD
- Programmable oscillator

The application allows you to exercise most of the board components. While using the application, you reconfigure the FPGA several times with test designs specific to the functionality you are testing.

The Board Test System GUI communicates over the JTAG bus to a test design running in the Arria II GX device. Figure 6-1 shows the initial GUI for a board that is in the factory configuration.

Figure 6-1. Board Test System Graphical User Interface

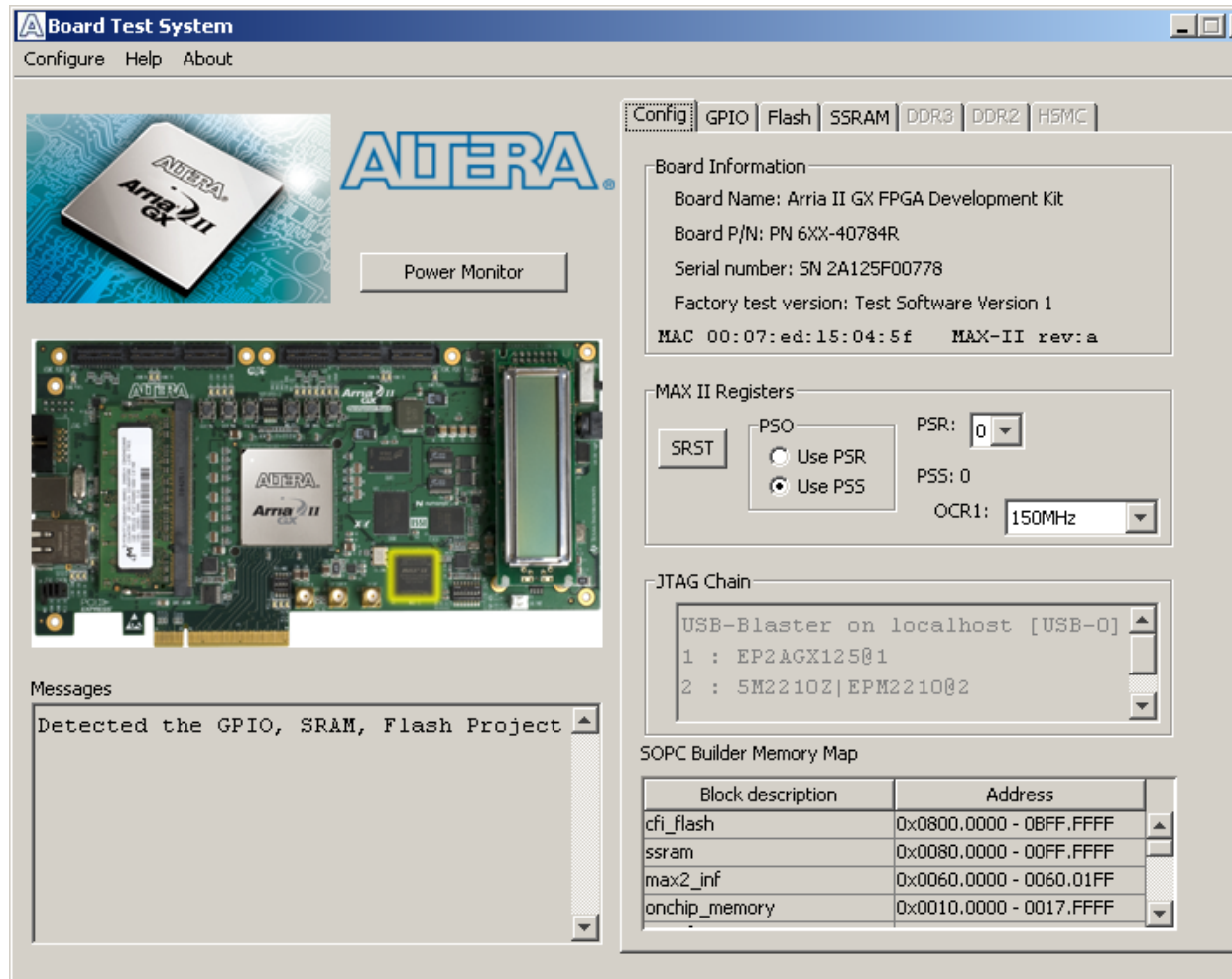

Several designs are provided to test the major board features. Each design provides data for one or more tabs in the application. The Configure menu identifies the appropriate design to download to the FPGA for each tab.

After successful FPGA configuration, the appropriate tab appears and allows you to exercise the related board features. Highlights appear in the board picture around the corresponding components.

The **Power Monitor** button starts the Power Monitor application that measures and reports current power information for the board. Because the application communicates over the JTAG bus to the MAX II device, you can measure the power of any design in the FPGA, including your own designs.

 The Board Test System and Power Monitor share the JTAG bus with other applications like the Nios II debugger and the SignalTap® II Embedded Logic Analyzer. Because the Quartus II programmer uses most of the bandwidth of the JTAG bus, other applications using the JTAG bus might time out. Be sure to close the other applications before attempting to reconfigure the FPGA using the Quartus II Programmer.

Preparing the Board

With the power to the board off, perform the following steps:

1. Connect the USB cable to the board.
2. Verify the settings for the board settings DIP switch bank (SW4) match [Table 4-2 on page 4-3](#).
3. Set the USER_LOAD switch (SW4.4) to the on position.
4. Verify the settings for the JTAG jumper block (J9) match [Table 4-3 on page 4-3](#). These settings determine the devices to include in the JTAG chain.

 For more information about the board's DIP switch and jumper settings, refer to the *Arria II GX FPGA Development Board Reference Manual*.

5. Turn the power to the board on. The board loads the design stored in the user hardware 1 portion of flash memory into the FPGA. If your board is still in the factory configuration or if you have downloaded a newer version of the Board Test System to flash memory through the Board Update Portal, the design loads the GPIO, SRAM, and flash memory tests.



To ensure operating stability, keep the USB cable connected and the board powered on when running the demonstration application. The application cannot run correctly unless the USB cable is attached and the board is on.

Running the Board Test System

To run the application, navigate to the *<install dir>\kits\arriaIIGX_2agx125_fpga\examples\board_test_system* directory and run the **BoardTestSystem.exe** application.

 On Windows, click **Start > All Programs > Altera > Arria II GX FPGA Development Kit <version> > Board Test System** to run the application.

A GUI appears, displaying the application tab that corresponds to the design running in the FPGA. The Arria II GX FPGA development board's flash memory ships preconfigured with the design that corresponds to the **Config**, **GPIO**, and **SSRAM**, and **Flash** tabs.

 If you power up your board with the USER_LOAD switch (SW4.4) in the off position, or if you load your own design into the FPGA with the Quartus II Programmer, you receive a message prompting you to configure your board with a valid Board Test System design. Refer to "The Configure Menu" for information about configuring your board.

Using the Board Test System

This section describes each control in the Board Test System application.

The Configure Menu

Each test design tests different functionality and corresponds to one or more application tabs. Use the Configure menu to select the design you want to use. Figure 6-2 shows the Configure menu.

Figure 6-2. The Configure Menu

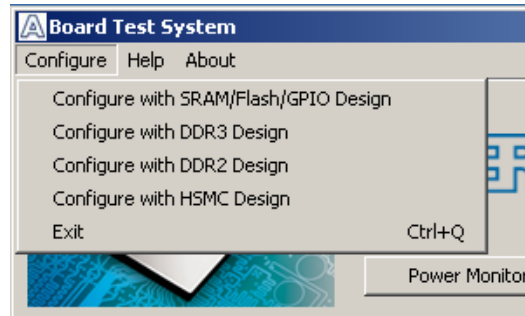

To configure the FPGA with a test system design, follow these steps:

1. On the Configure menu, click the configure command that corresponds to the functionality you wish to test.
2. In the dialog box that appears, click **Configure** to download the corresponding design's SRAM Object File (.sof) to the FPGA. The download process usually takes about a minute.
3. When configuration finishes, click **Close** to complete the configuration process and run the design in the FPGA. A corresponding application tab appears in the GUI that interfaces with the design in the FPGA.

The Config Tab

The **Config** tab shows information about the board's current configuration. Figure 6-1 on page 6-2 shows the **Config** tab. The tab displays the contents of the MAX II registers, the MAX II code version, the JTAG chain, the board's MAC address, and the flash memory map.

The following sections describe the controls on the **Config** tab.

MAX II Registers

The **MAX II registers** control allow you to view and change the current MAX II register values as described in Table 6–1. Changes to the register values with the GUI take effect immediately. For example, selecting a new frequency in the **OCR1** list immediately changes the clock frequency on the board.

Table 6–1. MAX II Registers

Register Name	Read/Write Capability	Description
System Reset (SRST)	Write only	Set to 0 to initiate an FPGA reconfiguration.
Page Select Register (PSR)	Read / Write	Determines which of the up to eight (0-7) pages of flash memory to use for FPGA reconfiguration. The flash memory ships with pages 0 and 1 preconfigured.
Page Select Override (PSO)	Read / Write	When set to 0, the value in PSR determines the page of flash memory to use for FPGA reconfiguration. When set to 1, the value in PSS determines the page of flash memory to use for FPGA reconfiguration
Page Select Switch (PSS)	Read only	Holds the current value of the illuminated CONFIG LED (D11-D13) based on the following encoding: <ul style="list-style-type: none"> ■ 0 = CONFIG LED (D13) and corresponds to the flash memory page for the factory hardware design ■ 1 = CONFIG LED (D12) and corresponds to the flash memory page for the user hardware 1 design ■ 2 = CONFIG LED (D11) and corresponds to the flash memory page for the user hardware 2 design
Oscillator Control Register 1 (OCR1)	Read / Write	Determines the U26 oscillator output frequency based on the following options: <ul style="list-style-type: none"> ■ 0 = 100 MHz ■ 1 = 125 MHz ■ 2 = 150 MHz ■ 3 = 156.25 MHz
Oscillator Control Register 2 (OCR2)	Read / Write	Determines the U30 oscillator output frequency based on the following options: <ul style="list-style-type: none"> ■ 0 = 100 MHz ■ 1 = 125 MHz ■ 2 = 150 MHz ■ 3 = 156.25 MHz <p>You cannot change OCR2 from the GUI.</p>

- **PSO**—Sets the MAX II PSO register. The following options are available:
 - **Use PSR**—Allows the PSR to determine the page of flash memory to use for FPGA reconfiguration.
 - **Use PSS**—Allows the PSS to determine the page of flash memory to use for FPGA reconfiguration.

- **PSR**—Sets the MAX II PSR register. The numerical values in the list corresponds to the page of flash memory to load during FPGA reconfiguration. Refer to [Table 6-1](#) for more information.
- **PSS**—Displays the MAX II PSS register value. Refer to [Table 6-1](#) for the list of available options.
- **OCR1**—Sets the MAX II OCR1 register. Refer to [Table 6-1](#) for the list of available options.
- **SRST**—Resets the system and reloads the FPGA with a design from flash memory based on the other MAX II register values. Refer to [Table 6-1](#) for more information.



Because the **Config** tab requires that a specific design is running in the FPGA at a specific clock speed, writing a 0 to SRST; writing a 1, 2, or 3 to OCR2; or changing the PSO value can cause the Board Test System to stop running.

JTAG Chain

This control shows all the devices currently in the JTAG chain. The Arria II GX device is always the first device in the chain.



Uninstalling the shunt jumper from jumper J9 pins 1-2 includes the MAX II device in the JTAG chain.

Board Information

This control displays static information about your board.

- **MAX-II rev**—Indicates the version of MAX II code currently running on the board. The MAX II code resides in the `<install dir>\kits\arriaIIGX_2agx125_fpga\examples` directory. Newer revisions of this code might be available on the [Arria II GX FPGA Development Kit](#) page of the Altera website.
- **MAC**—Indicates the MAC address of the board.

Flash Memory Map

This control shows the memory map of the flash memory device on your board.

The GPIO Tab

The GPIO tab allows you to interact with all the general purpose user I/O components on your board. You can write to the LCD, read DIP switch settings, turn LEDs on or off, and detect push button presses. Figure 6-3 shows the GPIO tab.

Figure 6-3. The GPIO Tab

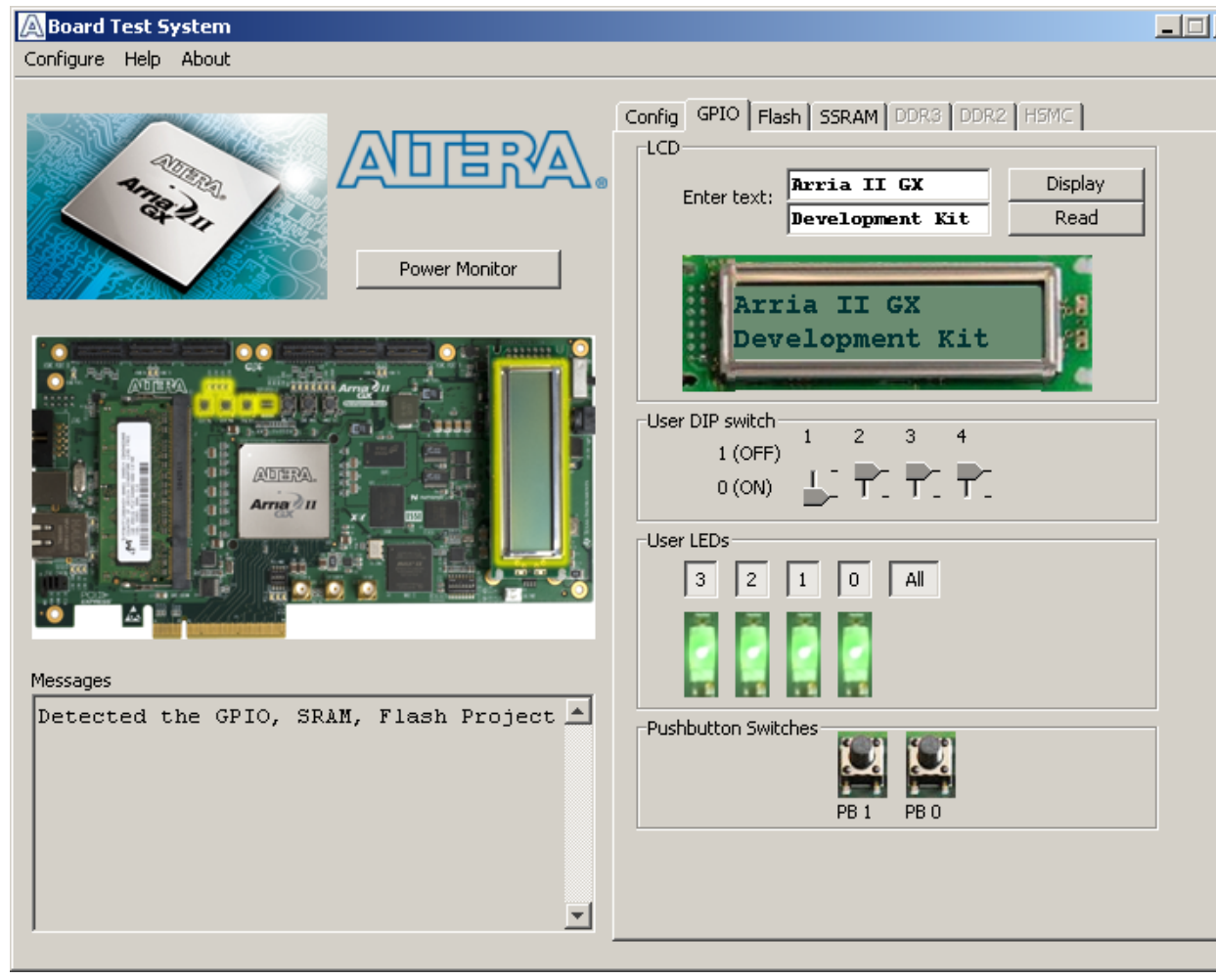

The following sections describe the controls on the GPIO tab.

LCD

This control allows you to display text strings on the character LCD on your board. Type text in the text boxes and then click **Write**.



If you exceed the 16 character display limit on either line, a warning message appears.

User Dipswitch

This read-only control displays the current positions of the switches in the user DIP switch bank (SW2). Change the switches on the board to see the graphical display change accordingly.

User LEDs

This control displays the current state of the user LEDs. Click the graphical representation of the LEDs to turn the board LEDs on and off.

Pushbutton Switches

This read-only control displays the current state of the board user push buttons. Press a push button on the board to see the graphical display change accordingly.

The Flash Tab

The **Flash** tab allows you to read and write flash memory on your board. [Figure 6-4](#) shows the **Flash** tab.

Figure 6-4. The Flash Tab

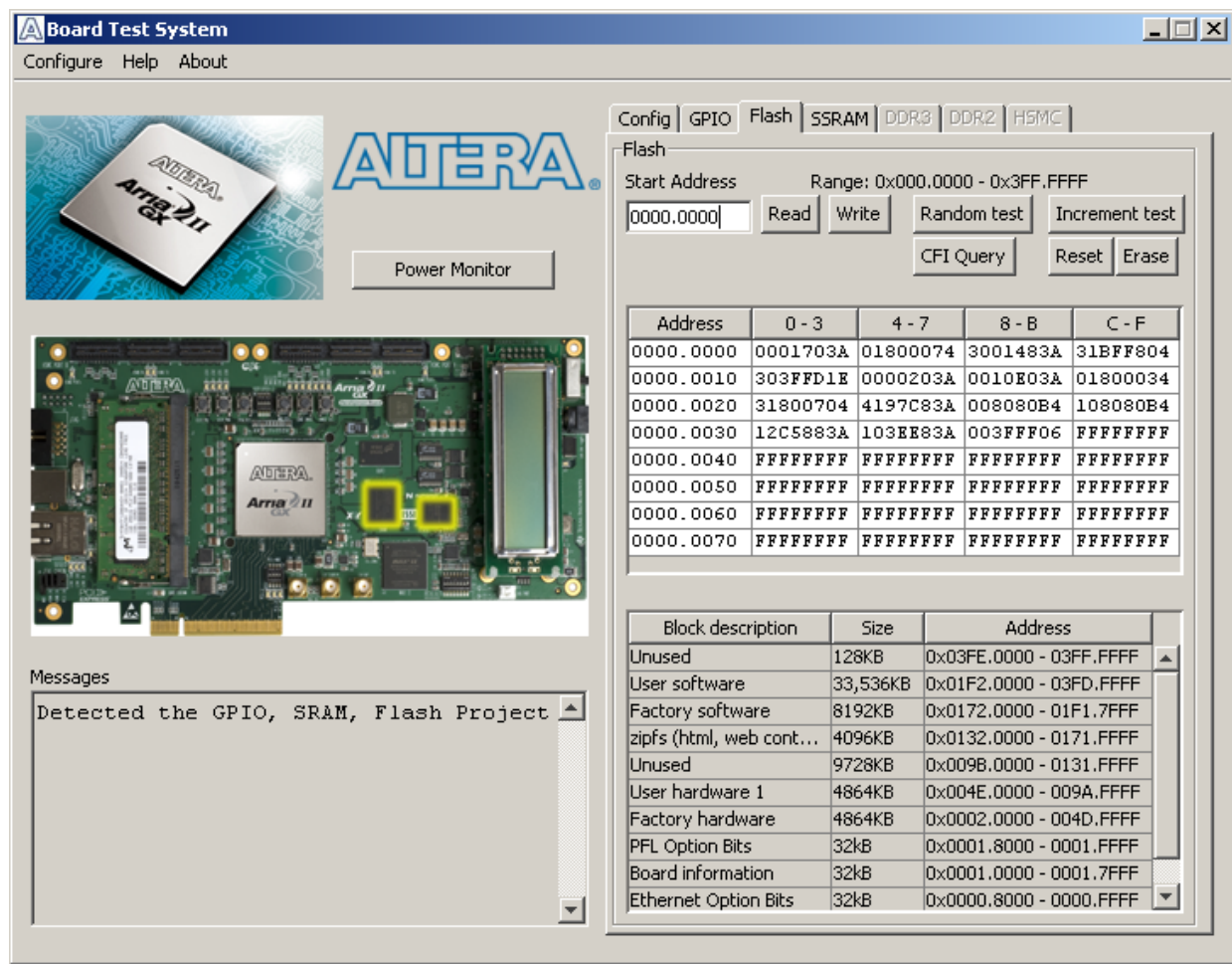

The following sections describe the controls on the **Flash** tab.

Read

The **Read** control reads the flash memory on your board. To see the flash memory contents, type a starting address in the text box and click **Read**. Values starting at the specified address appear in the table. The base address of flash memory in this Nios II-based BTS design is 0x0800.0000. The valid address range within the 64-MB flash memory is 0x0000.0000 through 0x03FF.FFFF, as shown in the GUI.



If you enter an address outside of the 0x0000.0000 to 0x003F.FFFF flash memory address space, a warning message identifies the valid flash memory address range.

Write

The **Write** control writes the flash memory on your board. To update the flash memory contents, change values in the table and click **Write**. The application writes the new values to flash memory and then reads the values back to guarantee that the graphical display accurately reflects the memory contents.



To prevent overwriting the dedicated portions of flash memory, the application limits the writable flash memory address range from 0x03FE.0000 to 0x003F.FFFF (which corresponds to the unused flash memory address range shown in [Figure 6-1](#) on page 6-2 and [Table A-1](#) on page A-1).

Random Test

Starts a random data pattern test to flash memory. Limited to scratch page in the upper 128K block.

CFI Query

The **CFI Query** control updates the memory table, displaying the CFI ROM table contents from the flash device.

Increment Test

Starts an incrementing data pattern test to flash memory. Limited to scratch page in the upper 128K block.

Reset

The **Reset** control executes the flash device's reset command and updates the memory table displayed on the **Flash** tab.

Erase

Erases flash memory. Limited to scratch page in the upper 128K blocks.

Flash Memory Map

Displays the flash memory map for the Arria II GX FPGA Development Kit.

The SSRAM Tab

The **SSRAM** tab allows you to read and write SRAM and flash memory on your board. Figure 6-5 shows the **SSRAM** tab.

Figure 6-5. The SSRAM Tab

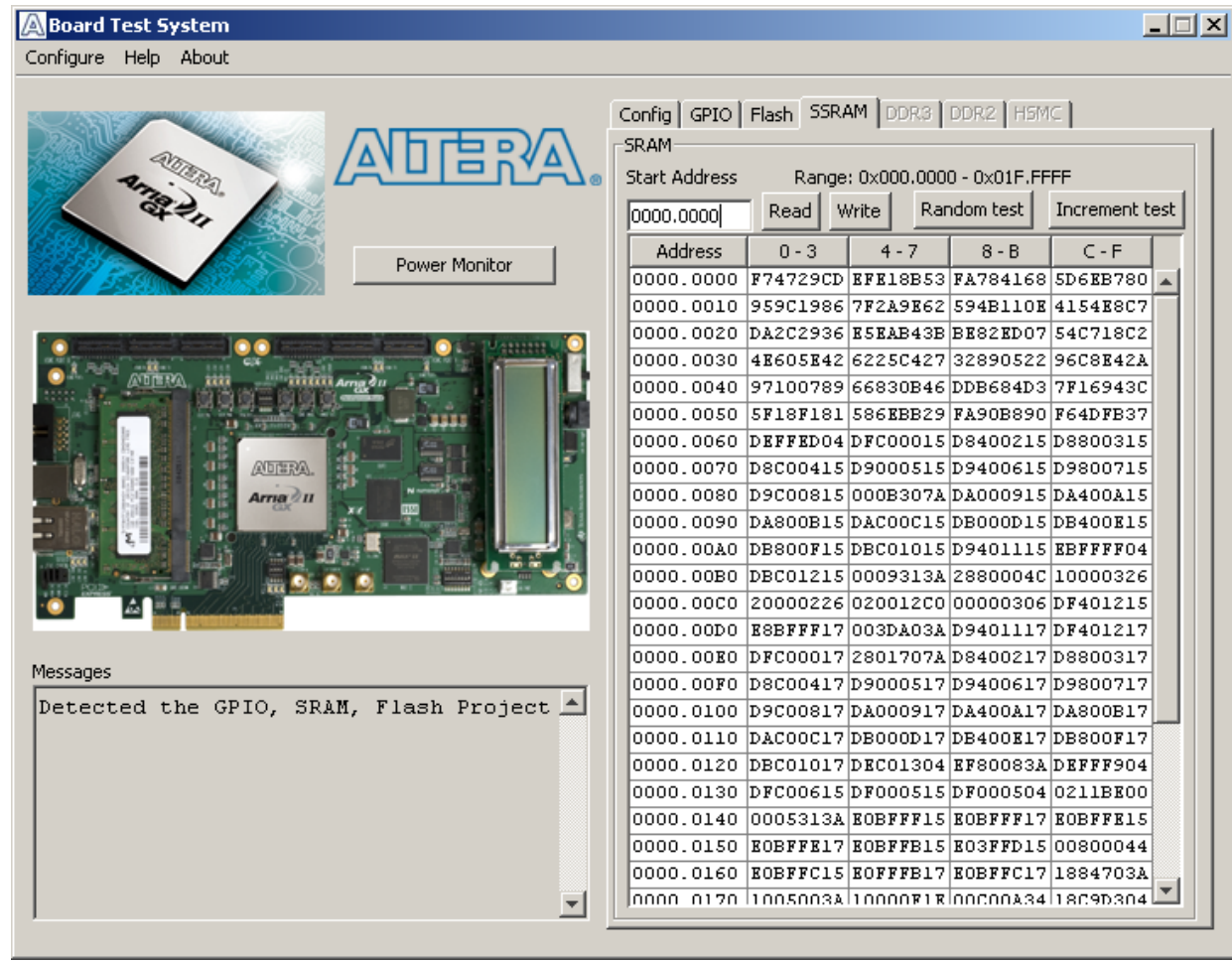

The following sections describe the controls on the **SSRAM** tab.

Read

This control allows you to read and write the SRAM on your board. Type a starting address in the text box and click **Read**. Values starting at the specified address appear in the table. The base address of SRAM in this Nios II-based BTS design is 0x0D00.0000. The valid address range within the 2-MB SRAM is 0x0000.0000 through 0x001F.FFFF, as shown in the GUI.



If you enter an address outside of the 0x0000.0000 to 0x001F.FFFF SRAM address space, a warning message identifies the valid SRAM address range.

Write

The **Write** control writes the SRAM on your board. To update the SRAM contents, change values in the table and click **Write**. The application writes the new values to SRAM and then reads the values back to guarantee that the graphical display accurately reflects the memory contents.

Random Test

Starts a random data pattern test to flash memory.

Increment Test

Starts an incrementing data pattern test to flash memory.

The DDR3 Tab

The **DDR3** tab allows you to read and write the DDR3 memory on your board. Figure 6-6 shows the **DDR3** tab.

Figure 6-6. The DDR3 Tab

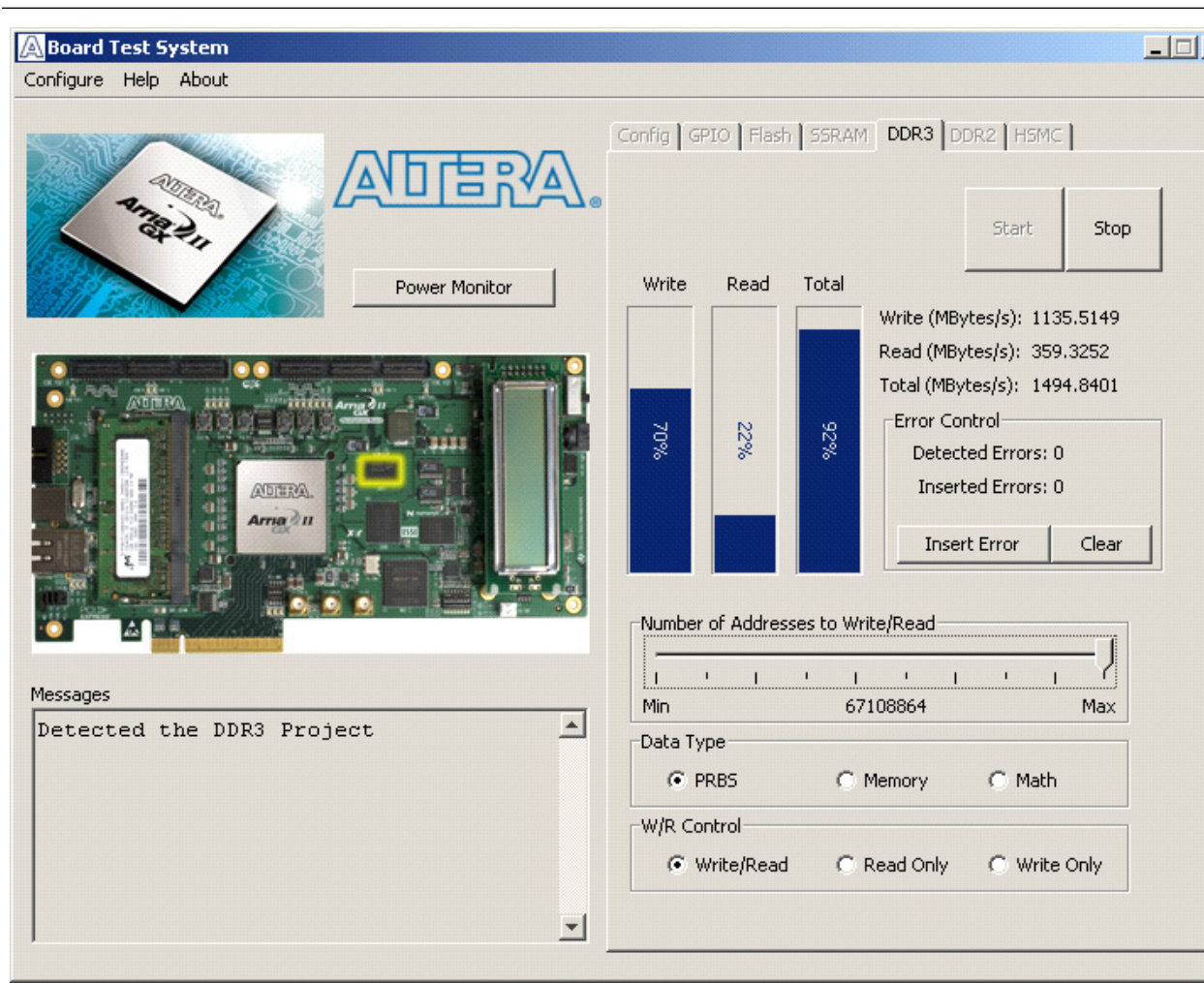

The following sections describe the controls on the **DDR3** tab.

Start

This control initiates DDR3 memory transaction performance analysis.

Stop

This control terminates transaction performance analysis.

Performance Indicators

These controls display current transaction performance analysis information collected since you last pressed **Start**:

- **Write, Read, and Total** performance bars—Show the percentage of maximum theoretical data rate that the requested transactions are able to achieve.
- **Write (MBytes/s), Read (MBytes/s), and Total (MBytes/s)**—Show the number of bytes of data analyzed per second. The data bus is 16 bits wide and the frequency¹ is 400 MHz double data rate (800 Mbps per pin), equating to a theoretical maximum bandwidth of 1600 MBps.

Error Control

These controls display data errors detected during analysis and allow you to insert errors:

- **Detected Errors**—Displays the number of data errors detected in the hardware.
- **Inserted Errors**—Displays the number of errors inserted into the transaction stream.
- **Insert Error**—Inserts a one-word error into the transaction stream each time you click the button. **Insert Error** is only enabled during transaction performance analysis.
- **Clear**—Resets the **Detected errors** and **Inserted errors** counters to zeros.

Number of Addresses to Write/Read

This control determines the number of addresses to use in each iteration of reads and writes. Valid values range from 8 to 67108864.

- The minimum range, when on the slider is at the *Min* position on the left, is the maximum PHY burst of 8.
- The maximum range, when the slider is at the *Max* position on the right, fills the full address space of the DDR3.

Data Type

This control specifies the type of data contained in the transactions. The following data types are available for analysis:

- **PRBS**—Selects pseudo-random bit sequences.

¹Frequency rates for production silicon speed grade C4N only.

- **Memory**—Selects a generic data pattern stored in the on chip memory of the Arria II GX device.
- **Math**—Selects data generated from a simple math function within the FPGA fabric.

W/R Control

This control specifies the type of transactions to analyze. The following transaction types are available for analysis:

- **Write/Read**—Selects read and write transactions for analysis.
- **Read Only**—Selects read transactions for analysis.
- **Write Only**—Selects write transactions for analysis.

The DDR2 Tab

The DDR2 tab allows you to read and write the DDR2 memory on your board. Figure 6-7 shows the DDR2 tab.

Figure 6-7. The DDR2 Tab

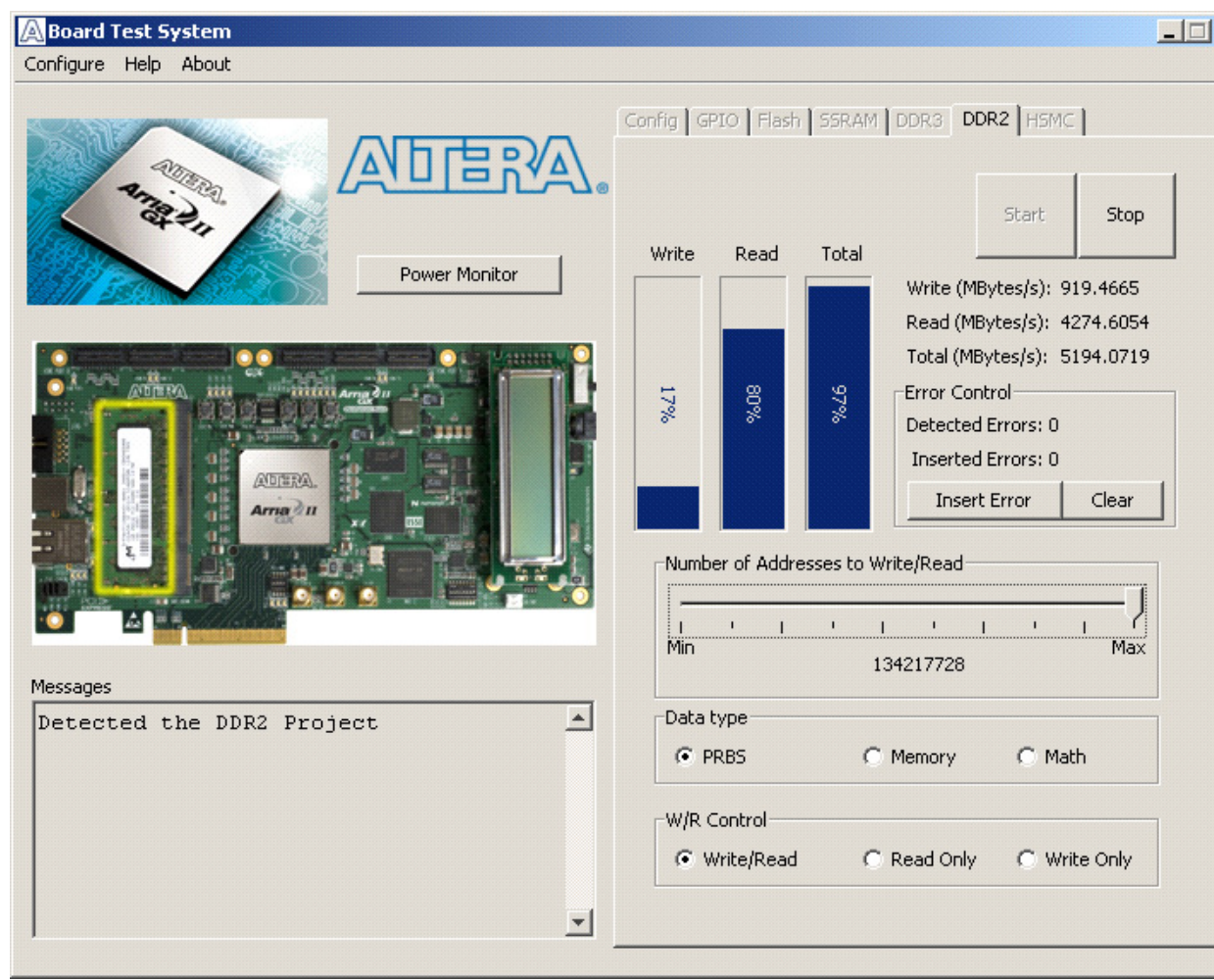

The following sections describe the controls on the **DDR2** tab.

Start

This control initiates DDR2 memory transaction performance analysis.

Stop

This control terminates transaction performance analysis.

Performance Indicators

These controls display current transaction performance analysis information collected since you last clicked **Start**:

- **Write, Read, and Total** performance bars—Show the percentage of maximum theoretical data rate that the requested transactions are able to achieve.
- **Write (MBytes/s), Read (MBytes/s), and Total (MBytes/s)**—Show the number of bytes of data analyzed per second. The data bus is 64 bits wide and the frequency¹ is 333 MHz double data rate (667 Mbps per pin), equating to a theoretical maximum bandwidth of 5333 MBps.

Error Control

This control displays data errors detected during analysis and allows you to insert errors:

- **Detected Errors**—Displays the number of data errors detected in the hardware.
- **Inserted Errors**—Displays the number of errors inserted into the transaction stream.
- **Insert Error**—Inserts a one-word error into the transaction stream each time you click the button. **Insert Error** is only enabled during transaction performance analysis.
- **Clear**—Resets the **Detected errors** and **Inserted errors** counters to zeros.

Number of Addresses to Write/Read

This control determines the number of addresses to use in each iteration of reads and writes. Valid values range from 8 to 134217728.

- The minimum range, when on the slider is at the *Min* position on the left, is the maximum PHY burst of 8.
- The maximum range, when the slider is at the *Max* position on the right, fills the full address space of the DDR2 SODIMM.

Data Type

This control specifies the type of data contained in the transactions. The following data types are available for analysis:

- **PRBS**—Selects pseudo-random bit sequences.

¹Frequency rates for production silicon speed grade C4N only.

- **Memory**—Selects a generic data pattern stored in the on chip memory of the Arria II GX device.
- **Math**—Selects data generated from a simple math function within the FPGA fabric.

W/R Control

This control specifies the type of transactions to analyze. The following transaction types are available for analysis:

- **Write/Read**—Selects read and write transactions for analysis.
- **Read Only**—Selects read transactions for analysis.
- **Write Only**—Selects write transactions for analysis.

The HSMC Tab

The HSMC tab allows you to perform loopback tests on the HSMC port. Figure 6-8 shows the HSMC tab.

Figure 6-8. The HSMC Tab

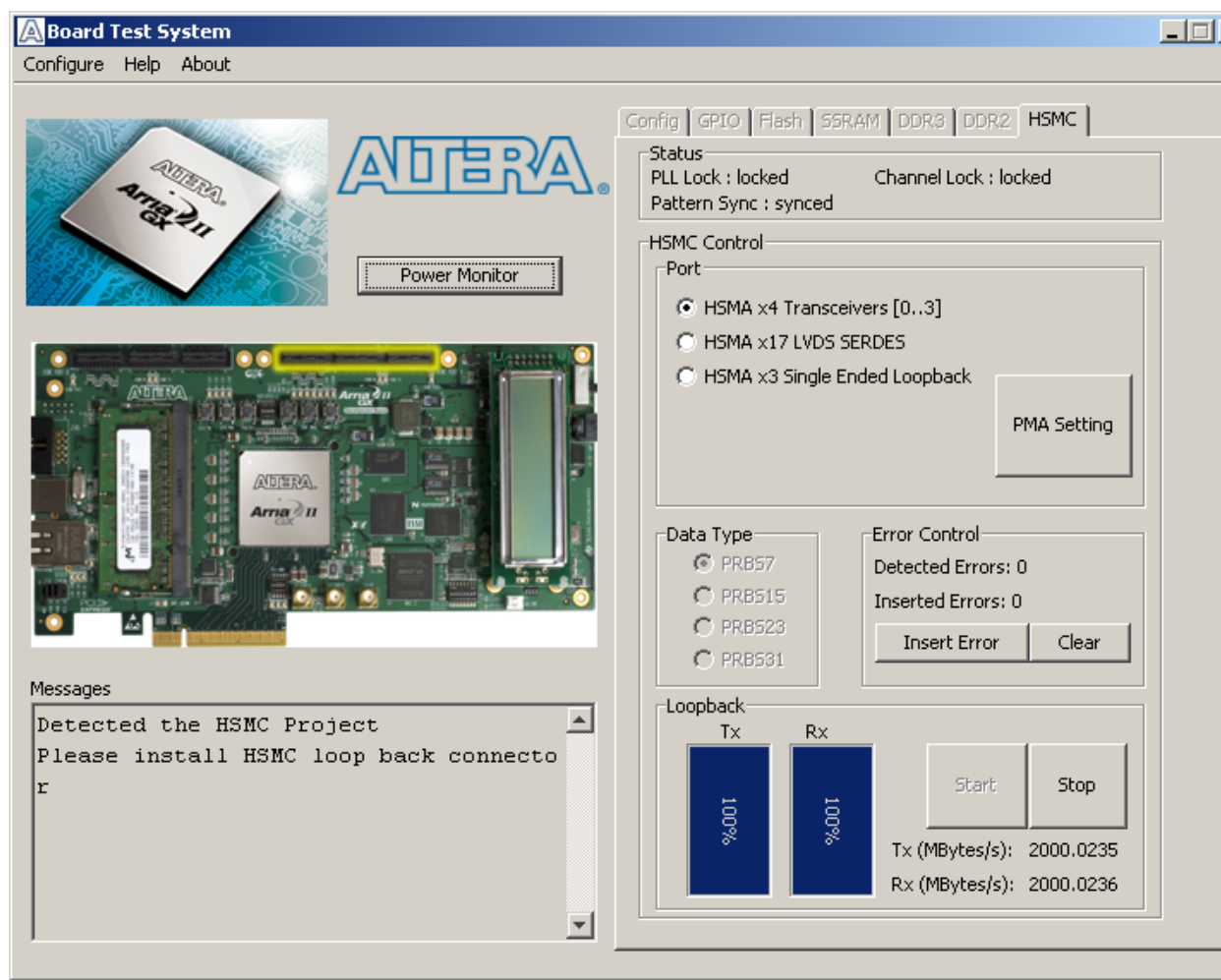



You must have the loopback HSMC installed on the HSMC connector that you are testing for this test to work correctly.

The following sections describe the controls on the **HSMC** tab.

Status

This control displays the following status information during the loopback test:

- **PLL lock**—Shows the PLL locked or unlocked state.
- **Channel lock**—Shows the channel locked or unlocked state. When locked, all lanes are word aligned and channel bonded.
- **Pattern sync**—Shows the pattern synced or not synced state. The pattern is considered synced when the start of the data sequence is detected.

Port

This control allows you to specify the type of test to run on the HSMC ports. The following HSMC port tests are available:

- **HSMA x4 Tranceivers [0..3]**
- **HSMA x17 LVDS SERDES**
- **HSMA x3 single-ended loopback**

PMA Setting

The **PMA Setting** button allows you to make changes to the PMA parameters that affect the active transceiver interface. The following settings are available for analysis:

- **Serial Loopback**—Routes signals from the receiver to the transmitter.
- **VOD**—Specifies the voltage output differential of the transmitter buffer.
- **Pre-emphasis tap**
 - **Pre**—Specifies the amount of pre-emphasis on the pre-tap of the transmitter buffer.
 - **First post**—Specifies the amount of pre-emphasis on the first post tap of the transmitter buffer.
 - **Second post**—Specifies the amount of pre-emphasis on the second post tap of the transmitter buffer.
- **Equalizer**—Specifies the setting for the receiver equalizer.
- **DC gain**—Specifies the DC portion of the receiver equalizer.



For restrictions on the PMA settings, refer to *Volume 2: Transceivers* of the *Arria II Device Handbook*.

Data Type

This control specifies the type of data contained in the transactions. The following data types are available for analysis:

- **PRBS**—Selects pseudo-random bit sequences.

- **Memory**—Selects a generic data pattern stored in the on chip memory of the Arria II GX device.
- **Math**—Selects data generated from a simple math function within the FPGA fabric.

Error Control

This control displays data errors detected during analysis and allows you to insert errors:

- **Detected Errors**—Displays the number of data errors detected in the hardware.
- **Inserted Errors**—Displays the number of errors inserted into the transmit data stream.
- **Insert Error**—Inserts a one-word error into the transmit data stream each time you click the button. **Insert Error** is only enabled during transaction performance analysis.
- **Clear**—Resets the **Detected errors** and **Inserted errors** counters to zeros.

Start

This control initiates HSMC transaction performance analysis.

Stop

This control terminates transaction performance analysis.

Performance Indicators

These controls display current transaction performance analysis information collected since you last clicked **Start**:

- **TX and RX performance bars**—Show the percentage of maximum theoretical data rate that the requested transactions are able to achieve.
- **Tx (MBytes/s) and Rx (MBytes/s)**—Show the number of bytes of data analyzed per second. The HSMA transceiver bus is 4 bits wide and the data rate is 3.75 Gbps, totaling 1.5625 GBps full-duplex. The LVDS SERDES bus is 17 bits wide. The transmit data bus is 16 bits wide and the frequency is 300 MHz double data rate (600 Mbps per pin), equating to a theoretical maximum bandwidth of 1200 MBps.

The Power Monitor

The Power Monitor measures and reports current power information for the board. To start the application, click **Power Monitor** in the Board Test System application.

 You can also run the Power Monitor as a stand-alone application. **PowerTool.exe** resides in the `<install dir>\kits\arriaIIGX_2agx125_fpga\examples\board_test_system` directory. On Windows, click **Start > All Programs > Altera > Arria II GX FPGA Development Kit <version> > Power Monitor** to start the application.

The Power Monitor communicates with the MAX II device on the board through the JTAG bus. A power monitor circuit attached to the MAX II device allows you to measure the power that the Arria II GX FPGA device is consuming regardless of the design currently running. Figure 6-9 shows the Power Monitor.

Figure 6-9. The Power Monitor

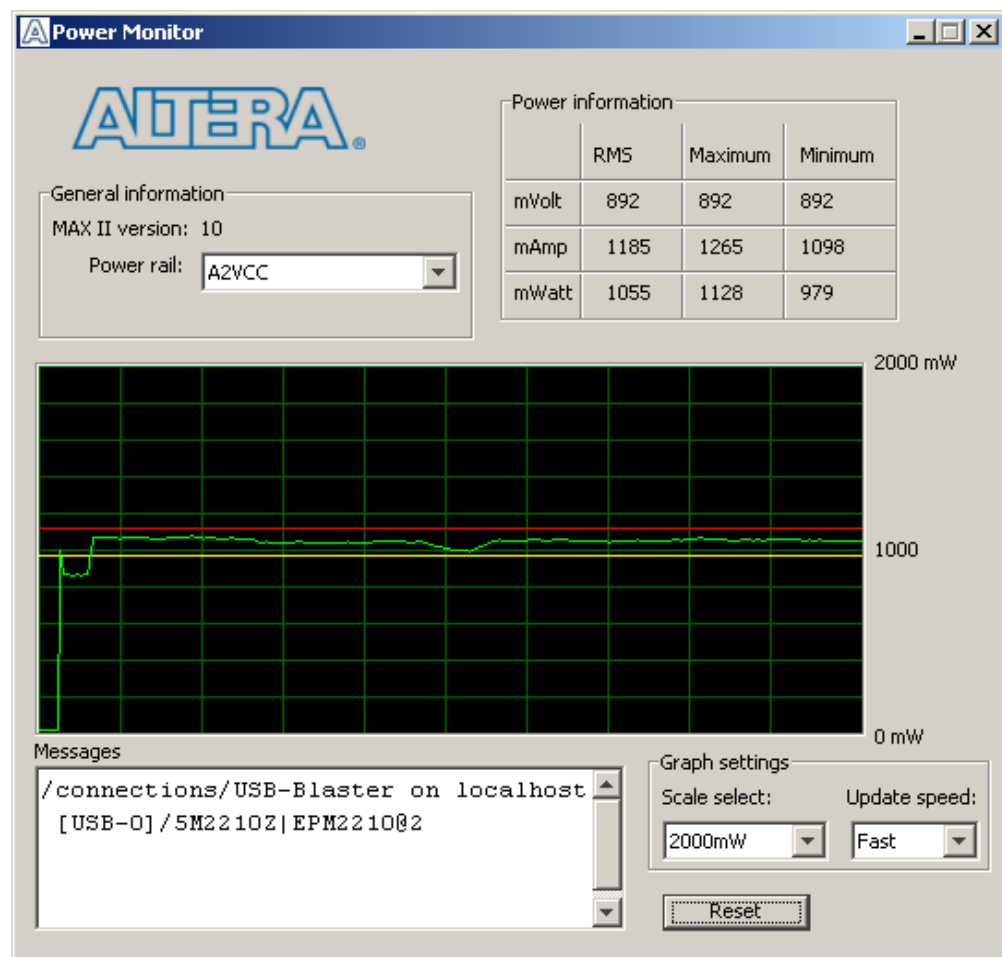

The following sections describe the Power Monitor controls.

General Information

The **General information** controls display the following information about the MAX II device:

- **MAX II Version**—Indicates the version of MAX II code currently running on the board. The MAX II code resides in the `<install dir>\kits\arriaIIGX_2agx125_fpga\factory_recovery` and `<install dir>\kits\arriaIIGX_2agx125_fpga\examples\max2` directories. Newer revisions of this code might be available on the [Arria II GX FPGA Development Kit](#) page of the Altera website.
- **Power Rail**—Selects the power rail to measure. After selecting the desired rail, click **Reset** to refresh the screen with new board readings.

 A table with the power rail information is available in the *Arria II GX FPGA Development Board Reference Manual*.

Power Information

This control displays RMS current, maximum, and minimum power readings for the following units:

- **mVolt**
- **mAmp**
- **mWatt**

Power Graph

This control displays the mWatt power consumption of your board over time. The green line indicates the current value. The red line indicates the maximum value read since the last reset. The yellow line indicates the minimum value read since the last reset.

Graph Settings

The following controls allow you to define the look and feel of the power graph:

- **Scale Select**—Specifies the amount to scale the power graph. Select a smaller number to zoom in to see finer detail. Select a larger number to zoom out to see the entire range of recorded values.
- **Update Speed**—Specifies how often to refresh the graph.

Reset

This control clears the graph, resets the minimum and maximum values, and restarts the Power Monitor.

Calculating Power

The Power Monitor calculates power by measuring two different voltages with the LT2418 A/D and applying the equation $P = V \times I$ to determine the power consumption. The LT2418 measures the voltage after the appropriate sense resistor (V_{sense}) and the voltage drop across that sense resistor (V_{dif}). The current (I) is calculated by dividing the measured voltage drop across the resistor by the value of the sense resistor ($I = V_{dif}/R$). Through substitution, the equation for calculating power becomes $P = V \times I = V_{sense} \times (V_{dif}/R) = (V_{sense}) \times (V_{dif}) \times (1/.009)$, except for the A2VCC rail which uses .001 for R .

You can verify the power numbers shown in the Power Monitor with a digital multimeter that is capable of measuring microvolts to ensure you have enough significant digits for an accurate calculation. Measure the voltage on one side of the resistor (the side opposite the power source) and then measure the voltage on the other side. The first measurement is V_{sense} and the difference between the two measurements is V_{dif} . Plug the values into the equation to determine the power consumption.

Configuring the FPGA Using the Quartus II Programmer

You can use the Quartus II Programmer to configure the FPGA with a specific .sof. Before configuring the FPGA, ensure that the Quartus II Programmer and the USB-Blaster driver are installed on the host computer, the USB cable is connected to the FPGA development board, power to the board is on, and no other applications that use the JTAG chain are running.

To configure the Arria II GX FPGA, perform the following steps:

1. Start the Quartus II Programmer.
2. Click **Add File** and select the path to the desired .sof.
3. Turn on the **Program/Configure** option for the added file.
4. Click **Start** to download the selected file to the FPGA. Configuration is complete when the progress bar reaches 100%.



Using the Quartus II programmer to configure a device on the board causes other JTAG-based applications such as the Board Test System and the Power Monitor to lose their connection to the board. Restart those applications after configuration is complete.

As you develop your own project using the Altera tools, you can program the flash memory device so that your own design loads from flash memory into the FPGA on power up. This appendix describes the preprogrammed contents of the common flash interface (CFI) flash memory device on the Arria II GX FPGA development board and the Nios II EDS tools involved with reprogramming the user portions of the flash memory device.

The Arria II GX FPGA development board ships with the CFI flash device preprogrammed with a default factory FPGA configuration for running the Board Update Portal design example and a default user configuration for running the Board Test System demonstration. There are several other factory software files written to the CFI flash device to support the Board Update Portal. These software files were created using the Nios II EDS, just as the hardware design was created using the Quartus II software.

 For more information about Altera development tools, refer to the [Design Software](#) page of the Altera website.

CFI Flash Memory Map

Table A-1 shows the default memory contents of the 512-Mb (64-MB) CFI flash device (Numonyx, PC28F512P30BF). For the Board Update Portal to run correctly and update designs in the user memory, this memory map must not be altered.

Table A-1. Byte Address Flash Memory Map (Part 1 of 2)

Block Description	Size	Address Range
Unused	32 KB	0x03FFFFFF 0x03FF8000
Unused	32 KB	0x03FF7FFF 0x03FF0000
Unused	32 KB	0x03FEFFFF 0x03FE8000
Unused	32 KB	0x03FE7FFF 0x03FE0000
User software	24,320 KB	0x03FDFFFF 0x02820000
Factory software	8,192 KB	0x0281FFFF 0x02020000
zipfs (html, web content)	8,192 KB	0x0201FFFF 0x01820000
Unused	6,357 KB	0x0181FFFF 0x01280000
User hardware 2	6,357 KB	0x0127FFFF 0x00C60000

Table A-1. Byte Address Flash Memory Map (Part 2 of 2)

Block Description	Size	Address Range
User hardware 1	6,357 KB	0x00C5FFFF 0x00640000
Factory hardware	6,357 KB	0x0063FFFF 0x00020000
PFL option bits	32 KB	0x0001FFFF 0x00018000
Board information	32 KB	0x00017FFF 0x00010000
Ethernet option bits	32 KB	0x0000FFFF 0x00008000
User design reset vector	32 KB	0x00007FFF 0x00000000



Altera recommends that you do not overwrite the factory hardware and factory software images unless you are an expert with the Altera tools. If you unintentionally overwrite the factory hardware or factory software image, refer to “Restoring the Flash Device to the Factory Settings” on page A-4.

Preparing Design Files for Flash Programming

You can obtain designs containing prepared **.flash** files from the [Arria II GX FPGA Development Kit](#) page of the Altera website or create **.flash** files from your own custom design.

The Nios II EDS **sof2flash** command line utility converts your Quartus II-compiled **.sof** into the **.flash** format necessary for the flash device. Similarly, the Nios II EDS **elf2flash** command line utility converts your compiled and linked Executable and Linking Format File (**.elf**) software design to **.flash**. After your design files are in the **.flash** format, use the Board Update Portal or the Nios II EDS **nios2-flash-programmer** utility to write the **.flash** files to the user hardware 1 and user software locations of the flash memory.



For more information about Nios II EDS software tools and practices, refer to the [Embedded Software Development](#) page of the Altera website.

Creating Flash Files Using the Nios II EDS

If you have an FPGA design developed using the Quartus II software, and software developed using the Nios II EDS, follow these instructions:

1. On the Windows Start menu, click **All Programs > Altera > Nios II EDS > Nios II Command Shell**.

2. In the Nios II command shell, navigate to the directory where your design files reside and type the following Nios II EDS commands:

- For Quartus II **.sof** files:

```
sof2flash --input=<yourfile>_hw.sof --output=<yourfile>_hw.flash --offset=0x00640000 --  
pfl --optionbit=0x18000 --programmingmode=PS
```

- For Nios II **.elf** files:

```
elf2flash --base=0x08000000 --end=0x0BFFFFFF --reset=0x0A020000  
--input=<yourfile>_sw.elf --output=<yourfile>_sw.flash  
--boot=$SOPC_KIT_NIOS2/components/altera_nios2/boot_loader_cfi.srec
```

-  For boards with dual-die CFI flash devices, use `--base=0x0A000000`. For more information, refer to the *Board Revision History* appendix of the *Arria II GX FPGA Development Board Reference Manual*.

The resulting **.flash** files are ready for flash device programming. If your design uses additional files such as image data or files used by the runtime program, you must first convert the files to **.flash** format and concatenate them into one **.flash** file before using the Board Update Portal to upload them.

-  The Board Update Portal standard **.flash** format conventionally uses either `<filename>_hw.flash` for hardware design files or `<filename>_sw.flash` for software design files.

Programming Flash Memory Using the Board Update Portal

Once you have the necessary **.flash** files, you can use the Board Update Portal to reprogram the flash memory. Refer to “Using the Board Update Portal to Update User Designs” on page 5-2 for more information.

-  If you have generated a **.sof** that operates without a software design file, you can still use the Board Update Portal to upload your design. In this case, leave the **Software File Name** field blank.

Programming Flash Memory Using the Nios II EDS

The Nios II EDS offers a **nios2-flash-programmer** utility to program the flash memory directly. To program the **.flash** files or any compatible S-Record File (**.srec**) to the board using **nios2-flash-programmer**, perform the following steps:

1. Set the USER_LOAD switch (SW4.4) to the off position to load the Board Update Portal design from flash memory on power up.
2. Attach the USB-Blaster cable and power up the board.
3. If the board has powered up and the LCD displays either "Connecting..." or a valid IP address (such as 152.198.231.75), proceed to step 8. If no output appears on the LCD or if the CONF DONE LED (D14) does not illuminate, continue to step 4 to load the FPGA with a flash-writing design.
4. Launch the Quartus II Programmer to configure the FPGA with a **.sof** capable of flash programming. Refer to “Configuring the FPGA Using the Quartus II Programmer” on page 6-20 for more information.

5. Click **Add File** and select *<install dir>\kits\arriaIIGX_2agx125_fpga\factory_recovery\ArriaIIGX_2agx125_dev_bup.sof*.
6. Turn on the **Program/Configure** option for the added file.
7. Click **Start** to download the selected configuration file to the FPGA. Configuration is complete when the progress bar reaches 100%. The CONF DONE LED (D14) and the four user LEDs (D7-D10) illuminate indicating that the flash device is ready for programming.
8. On the Windows Start menu, click **All Programs > Altera > Nios II EDS > Nios II Command Shell**.
9. In the Nios II command shell, navigate to the *<install dir>\kits\arriaIIGX_2agx125_fpga\factory_recovery* directory (or to the directory of the **.flash** files you created in “Creating Flash Files Using the Nios II EDS” on page A-2) and type the following Nios II EDS command:

```
nios2-flash-programmer --base=0x08000000 <yourfile>_hw.flash ↵
```

10. After programming completes, if you have a software file to program, type the following Nios II EDS command:

```
nios2-flash-programmer --base=0x08000000 <yourfile>_sw.flash ↵
```



For boards with dual-die CFI flash devices, use `--base=0x0A000000`. For more information, refer to the *Board Revision History* appendix of the *Arria II GX FPGA Development Board Reference Manual*.

11. Set the USER_LOAD switch (SW4.4) to the on position and power cycle the board to load and run the new user design.

Programming the board is now complete.



For more information about the `nios2-flash-programmer` utility, refer to the *Nios II Flash Programmer User Guide*.

Restoring the Flash Device to the Factory Settings

This section describes how to restore the original factory contents to the flash memory device on the FPGA development board. Make sure you have the Nios II EDS installed, and perform the following instructions:

1. Set the board switches to the factory default settings described in “Factory Default Switch Settings” on page 4-2.
2. Launch the Quartus II Programmer to configure the FPGA with a **.sof** capable of flash programming. Refer to “Configuring the FPGA Using the Quartus II Programmer” on page 6-20 for more information.
3. Click **Add File** and select *<install dir>\kits\arriaIIGX_2agx125_fpga\factory_recovery\ArriaIIGX_2agx125_dev_bup.sof*.
4. Turn on the **Program/Configure** option for the added file.

5. Click **Start** to download the selected configuration file to the FPGA. Configuration is complete when the progress bar reaches 100%. The CONF DONE LED (D14) and the four user LEDs (D7-D10) illuminate indicating that the flash device is ready for programming.
6. On the Windows Start menu, click **All Programs > Altera > Nios II EDS > Nios II Command Shell**.
7. In the Nios II command shell, navigate to the *<install dir>\kits\arriaIIGX_2agx125_fpga\factory_recovery* directory and type the following command to run the restore script:

```
./restore.sh ←
```

Restoring the flash memory might take several minutes. Follow any instructions that appear in the Nios II command shell.
8. After all flash programming completes, cycle the POWER switch (SW1) off then on.
9. Using the Quartus II Programmer, click **Add File** and select *<install dir>\kits\arriaIIGX_2agx125_fpga\factory_recovery\ArriaIIGX_2agx125_dev_bup.sof*.
10. Turn on the **Program/Configure** option for the added file.
11. Click **Start** to download the selected configuration file to the FPGA. Configuration is complete when the progress bar reaches 100%. The CONF DONE LED (D14) and the four user LEDs (D7-D10) illuminate indicating the flash memory device is now restored with the factory contents.
12. Cycle the POWER switch (SW1) off then on to load and run the restored factory design.
13. The restore script cannot restore the board's MAC address automatically. In the Nios II command shell, type the following Nios II EDS command:

```
nios2-terminal ←
```

and follow the instructions in the terminal window to generate a unique MAC address.

 To ensure that you have the most up-to-date factory restore files and information about this product, refer to the [Arria II GX FPGA Development Kit](#) page of the Altera website.

Restoring the MAX II CPLD to the Factory Settings

This section describes how to restore the original factory contents to the MAX II CPLD on the FPGA development board. Make sure you have the Nios II EDS installed, and perform the following instructions:

1. Set the board switches to the factory default settings described in “[Factory Default Switch Settings](#)” on page 4–2.



Uninstalling the shunt jumper from jumper J9 pins 1-2 includes the MAX II device in the JTAG chain.

2. Launch the Quartus II Programmer.
3. Click **Auto Detect**.
4. Click **Add File** and select *<install dir>\kits\arriaIIGX_2agx125_fpga\factory_recovery\max2.pof*.
5. Turn on the **Program/Configure** option for the added file.
6. Click **Start** to download the selected configuration file to the MAX II CPLD. Configuration is complete when the progress bar reaches 100%.



To ensure that you have the most up-to-date factory restore files and information about this product, refer to the [Arria II GX FPGA Development Kit](#) page of the Altera website.

This chapter provides additional information about the document and Altera.

Document Revision History

The following table shows the revision history for this document.

Date	Version	Changes
February 2011	1.1	Updates for production silicon speed grade C4N device, new single-die flash device, LVDS, DDR2 and DDR3 speed improvements.
July 2009	1.0	Initial release.

How to Contact Altera

To locate the most up-to-date information about Altera products, refer to the following table.

Contact (1)	Contact Method	Address
Technical support	Website	www.altera.com/support
Technical training	Website	www.altera.com/training
	Email	custrain@altera.com
Product literature	Website	www.altera.com/literature
Non-technical support (General) (Software Licensing)	Email	nacomp@altera.com
	Email	authorization@altera.com









Note to Table:

(1) You can also contact your local Altera sales office or sales representative.

Typographic Conventions

The following table shows the typographic conventions this document uses.

Visual Cue	Meaning
Bold Type with Initial Capital Letters	Indicate command names, dialog box titles, dialog box options, and other GUI labels. For example, Save As dialog box. For GUI elements, capitalization matches the GUI.
bold type	Indicates directory names, project names, disk drive names, file names, file name extensions, software utility names, and GUI labels. For example, \qdesigns directory, D: drive, and chiptrip.gdf file.
<i>Italic Type with Initial Capital Letters</i>	Indicate document titles. For example, <i>Stratix IV Design Guidelines</i> .
<i>italic type</i>	Indicates variables. For example, $n + 1$. Variable names are enclosed in angle brackets (< >). For example, <file name> and <project name>.pof file.

Visual Cue	Meaning
Initial Capital Letters	Indicate keyboard keys and menu names. For example, the Delete key and the Options menu.
“Subheading Title”	Quotation marks indicate references to sections within a document and titles of Quartus II Help topics. For example, “Typographic Conventions.”
Courier type	Indicates signal, port, register, bit, block, and primitive names. For example, <code>data1</code> , <code>tdi</code> , and <code>input</code> . The suffix <code>n</code> denotes an active-low signal. For example, <code>resetn</code> . Indicates command line commands and anything that must be typed exactly as it appears. For example, <code>c:\qdesigns\tutorial\chiptrip.gdf</code> . Also indicates sections of an actual file, such as a Report File, references to parts of files (for example, the AHDL keyword <code>SUBDESIGN</code>), and logic function names (for example, <code>TRI</code>).
	An angled arrow instructs you to press the Enter key.
1., 2., 3., and a., b., c., and so on	Numbered steps indicate a list of items when the sequence of the items is important, such as the steps listed in a procedure.
	Bullets indicate a list of items when the sequence of the items is not important.
	The hand points to information that requires special attention.
	A question mark directs you to a software help system with related information.
	The feet direct you to another document or website with related information.
 CAUTION	A caution calls attention to a condition or possible situation that can damage or destroy the product or your work.
 WARNING	A warning calls attention to a condition or possible situation that can cause you injury.
	The envelope links to the Email Subscription Management Center page of the Altera website, where you can sign up to receive update notifications for Altera documents.

Mouser Electronics

Authorized Distributor

Click to View Pricing, Inventory, Delivery & Lifecycle Information:

[Altera:](#)

[DK-DEV-2AGX125N](#)