



# **Intel® RAID Adapters**

## **RSP3TD160F, RSP3MD088F, RSP3DD080F and RSP3WD080E**

### ***Hardware User Guide***

A document providing an overview of product features, specification data, and hardware installation instructions

**Rev 1.5**  
**June 2021**

**Intel® Server Products and Solutions**

<Blank page>

## Document Revision History

Date Published	Revision	Revision Change Description
May 2017	1.0	Initial release
Sep 2019	1.1	Strip sizes corrected. Removed some conditions happening at launch. Added references to TPS document for cooling. Added missing MTBF data.
Dec 2019	1.2	RAID levels for iMR corrected.
Feb 2020	1.3	Corrected description for RSP3MD088F adapter. Corrected maximum supported devices for all adapters in the detailed description.
Apr 2020	1.4	Corrected support for NVMe drives on RSP3MD088F
Jun 2021	1.5	Corrected temperature and voltage values Corrected the dimension figures for RSP3WD080E Intel logo updated Section 7.3 added

## ***Disclaimers***

Intel technologies' features and benefits depend on system configuration and may require enabled hardware, software, or service activation. Performance varies depending on system configuration. No computer system can be absolutely secure. Check with your system manufacturer or retailer or learn more at Intel.com.

No license (express or implied, by estoppel or otherwise) to any intellectual property rights is granted by this document.

Intel disclaims all express and implied warranties, including without limitation, the implied warranties of merchantability, fitness for a particular purpose, and non-infringement, as well as any warranty arising from course of performance, course of dealing, or usage in trade.

The products and services described may contain defects or errors known as errata which may cause deviations from published specifications. Current characterized errata are available on request.

You may not use or facilitate the use of this document in connection with any infringement or other legal analysis concerning Intel products described herein. You agree to grant Intel a non-exclusive, royalty-free license to any patent claim thereafter drafted which includes subject matter disclosed herein.

Intel, the Intel logo, are trademarks of Intel Corporation in the U.S. and/or other countries.

\*Other names and brands may be claimed as the property of others.

© Intel Corporation 2017. All rights reserved.

## Safety Information

### Important Safety Instructions

Read all caution and safety statements in this document before performing any of the instructions. See also Intel Server Boards and Server Chassis Safety Information at

[https://www.intel.com/content/dam/support/us/en/documents/motherboards/server/sb/g23122-004\\_safetyregulatory.pdf](https://www.intel.com/content/dam/support/us/en/documents/motherboards/server/sb/g23122-004_safetyregulatory.pdf)

### Wichtige Sicherheitshinweise

Lesen Sie zunächst sämtliche Warnung und Sicherheitshinweise in diesem Dokument, bevor Sie eine der Anweisungen ausführen. Beachten Sie hierzu auch die Sicherheitshinweise zu Intel-Serverplatinen und Servergehäusen auf der

[https://www.intel.com/content/dam/support/us/en/documents/motherboards/server/sb/g23122-004\\_safetyregulatory.pdf](https://www.intel.com/content/dam/support/us/en/documents/motherboards/server/sb/g23122-004_safetyregulatory.pdf)

### Consignes de sécurité

Lisez attention toutes les consignes de sécurité et les mises en garde indiquées dans ce document avant de suivre toute instruction. Consultez Intel Server Boards and Server Chassis Safety Information sur le site

[https://www.intel.com/content/dam/support/us/en/documents/motherboards/server/sb/g23122-004\\_safetyregulatory.pdf](https://www.intel.com/content/dam/support/us/en/documents/motherboards/server/sb/g23122-004_safetyregulatory.pdf)

### Instrucciones de seguridad importantes

Lea todas las declaraciones de seguridad y precaución de este documento antes de realizar cualquiera de las instrucciones. Vea Intel Server Boards and Server Chassis Safety Information en

[https://www.intel.com/content/dam/support/us/en/documents/motherboards/server/sb/g23122-004\\_safetyregulatory.pdf](https://www.intel.com/content/dam/support/us/en/documents/motherboards/server/sb/g23122-004_safetyregulatory.pdf)

### 重要安全指导

在执行任何指令之前，请阅读本文档中的所有注意事项及安全声明。和/或

[https://www.intel.com/content/dam/support/us/en/documents/motherboards/server/sb/g23122-004\\_safetyregulatory.pdf](https://www.intel.com/content/dam/support/us/en/documents/motherboards/server/sb/g23122-004_safetyregulatory.pdf)

上的 *Intel® Server Boards and Server Chassis Safety Information*（《Intel 服务器主板与服务器机箱安全信息》）。

## Warnings

**Heed safety instructions:** Before working with your server product, whether you are using this guide or any other resource as a reference, pay close attention to the safety instructions. You must adhere to the assembly instructions in this guide to ensure and maintain compliance with existing product certifications and approvals. Use only the described, regulated components specified in this guide. Use of other products/components will void the UL listing and other regulatory approvals of the product and will most likely result in noncompliance with product regulations in the region(s) in which the product is sold.

**System power on/off:** The power button DOES NOT turn off the system AC power. To remove all power from the system, you must unplug the AC power cord from the wall outlet. Make sure the AC power cord is unplugged before you open the chassis, add, or remove any components.

**Hazardous conditions, devices and cables:** Hazardous electrical conditions may be present on power, telephone, and communication cables. Turn off the server and disconnect the power cord, telecommunications systems, networks, and modems attached to the server before opening it. Otherwise, personal injury or equipment damage can result.

**Installing or removing jumpers:** A jumper is a small plastic-encased conductor that slips over two jumper pins. Some jumpers have a small tab on top that you can grip with your fingertips or with a pair of fine needle nosed pliers. If your jumpers do not have such a tab, take care when using needle-nosed pliers to remove or install a jumper; grip the narrow sides of the jumper with the pliers, never the wide sides. Gripping the wide sides can damage the contacts inside the jumper, causing intermittent problems with the function controlled by that jumper. Take care to grip with, but not squeeze, the pliers or other tool you use to remove a jumper, or you may bend or break the pins on the board.

**Electrostatic discharge (ESD) and ESD protection:** ESD can damage disk drives, boards, and other parts. We recommend that you perform all procedures in this chapter only at an ESD workstation. If one is not available, provide some ESD protection by wearing an anti-static wrist strap attached to chassis ground, any unpainted metal surface on your server when handling parts.

**ESD and handling boards:** Always handle boards carefully. They can be extremely sensitive to ESD. Hold boards only by their edges. After removing a board from its protective wrapper or from the server, place the board component side up on a grounded, static-free surface. Use a conductive foam pad if available but not the board wrapper. Do not slide board over any surface.

# 1. Preface

---

## 1.1 About This Document

This document provides an overview of product features, specification data, and hardware installation instructions for the Intel® Redundant Array of Inexpensive Disks (RAID) Adapters RSP3TD160, RSP3MD088, RSP3DD080 and RSP3WD080

## 1.2 Document Organization

This document includes the following:

**Chapter 1 – Product Overview** – Provides a product overview of the features set and support specifications.

**Chapter 2 – General Feature Overview** – Provides a brief description for the features that are common for the products covered by this guide.

**Chapter 3 – Detailed Characteristics** – Provides details on the characteristics for each of the products covered by this guide.

**Chapter 4 – Connectivity and Drive Support** – Provides description of what drives are supported by the products covered by this guide and the way to connect them.

**Chapter 5 – Hardware Installation** - Provides support for the installation of the product on the Intel systems where they are supported.

**Chapter 6 – Safety and Regulatory**

**Chapter 7 – Intel® RAID Maintenance Free Backup Unit AXSRMFBU7** – Provides details of the Intel® RAID Maintenance-Free Backup Unit AXSRMFBU7 accessory option.

**Appendix A. Glossary of Terms**

**Reference Documents and Online Articles**

The following documents are available for download and will be useful to setting up and using the Intel RAID adapter.

Document Title	Description
<i>Intel® RAID Software User Guide for full featured and entry level RAID controllers</i>	A document that provides information on RAID Card Setup and usage of supported RAID utility software. <a href="http://www.intel.com/content/www/us/en/support/server-products/raid-products/000024126.html">http://www.intel.com/content/www/us/en/support/server-products/raid-products/000024126.html</a>
<i>What to Do when Unable to Enter BIOS or Intel® RAID BIOS Console During Boot for Intel® Server Boards</i>	Article ID: 000059999. If the Intel or OEM logo screen displays during POST, the BIOS entry or Intel® RAID BIOS console command prompts are not visible. To gain access to these prompts, disable the logo screen.
<i>Intel® Server Board S2600ST Product Family Technical Product Specification</i>	Appendix E provides guidance to provide adequate cooling when installing the RAID adapters on the P430XXMUXX and P430XXMFEN2 chassis.
<i>12 Gbps SAS or 6G SATA Data Transfer Controller Support for Intel® RAID Controllers</i>	Article ID# 000008025. A document that provides information on how and where the controller supports 12-Gbps SAS (6G SATA) data transfers.

### **1.3 Product Support Collaterals**

In addition to this user guide, Intel provides documentation, device driver updates, and utilities that may be necessary and/or useful for operation and support of this product. Additional product support collaterals can be downloaded from the following Intel websites:

For product documentation, go to the following Intel website: <http://www.intel.com/support/>

For product device drives and other software utilities, go to the following Intel website:

<https://downloadcenter.intel.com>



# Table of Contents

1.	Preface .....	i
1.1	About This Document.....	i
1.2	Document Organization.....	i
1.3	Product Support Collaterals .....	ii
1.	Product Overview.....	7
2.	Intel® Tri-Mode RAID adapters General Features.....	8
2.1	Overview .....	8
2.2	Benefits of the SAS Interface .....	8
2.3	Benefits of the NVM Express (NVMe) interface.....	8
2.4	Intel® Tri-Mode RAID Adapter Features.....	8
2.4.1	SAS Features.....	8
2.4.2	SATA III Features.....	9
2.4.3	NVMe Interface Features .....	9
2.4.4	Usability Features .....	9
2.4.5	Flexibility Features.....	9
2.4.6	Drive Roaming .....	9
2.4.7	Drive Migration .....	10
2.4.8	Safety Characteristics .....	10
2.5	Intel® Tri-Mode RAID adapters Feature Set.....	11
2.6	Data Protection Features.....	13
2.7	Fault Tolerance Features .....	13
2.8	Array Performance Features .....	13
2.9	Drive Support Limits.....	14
2.10	Over temperature protection .....	14
2.11	UART Interface .....	14
2.12	Optional Intel® RAID Maintenance Free Backup Unit (RMFBU) .....	15
3.	Intel® Tri-Mode RAID Adapters Detailed Characteristics .....	16
3.1	Intel RAID Adapter RSP3TD160F Description.....	16
3.2	Intel RAID Adapter RSP3TD160F Dimensions .....	17
3.2.1	Intel RAID Adapter RSP3TD160F Electrical, Thermal and Atmospheric Requirements.....	18
3.2.2	Intel RAID Adapter RSP3TD160F Power Consumption .....	18
3.3	Intel RAID Adapter RSP3DD080F.....	19
3.4	Intel RAID Adapter RSP3DD080F Dimensions.....	20
3.4.1	Intel RAID Adapter RSP3DD080F Electrical, Thermal and Atmospheric Requirements. ....	21
3.4.2	Intel RAID Adapter RSP3DD080F Power Consumption.....	21
3.5	Intel RAID Adapter RSP3MD088F .....	22
3.6	Intel RAID Adapter RSP3MD088F Dimensions .....	23
3.6.1	Intel RAID Adapter RSP3MD088F Electrical, Thermal and Atmospheric Requirements.....	24
3.6.2	Intel RAID Adapter RSP3MD088F Consumption. ....	24
3.7	Intel RAID Adapter RSP3WD080E.....	25
3.8	Intel RAID Adapter RSP3WD080E Dimensions .....	26
3.8.1	Intel RAID Adapter RSP3WD080E Electrical, Thermal and Atmospheric Requirements. ....	27
3.8.2	Intel RAID Adapter RSP3WD080E Power Consumption. ....	27
4.	Connectivity and Drive Support.....	28
4.1	Connectivity and Drive Support.....	28
4.2	Connector Pinout.....	28

4.3	SAS/SATA Drive Support .....	29
4.4	Intel® 12 Gb/s SAS 3.0 Expander Support.....	30
4.4.1	SAS Expander Configuration for the Intel® RSP3TD160F RAID Adapter .....	30
4.5	NVMe Drive Support.....	32
5.	Hardware Installation .....	34
5.1	RAID Adapter Installation.....	35
5.1.1	Requirements .....	35
5.1.2	Packing List.....	35
5.1.3	Installation Instructions .....	35
6.	Safety and Regulatory (Class A).....	38
6.1	Product Safety Compliance .....	38
6.2	Product EMC Compliance – Class A Compliance .....	38
6.3	Product Environmental Compliance.....	38
7.	Intel® RAID Maintenance Free Backup Unit AXRMFBU7 .....	40
7.1	Intel® RAID Maintenance Free Backup Unit AXRMFBU7 .....	40
7.2	FBU345 Specifications and Layout.....	41
7.2.1	Extender Cable .....	43
7.3	Intel® RAID Maintenance Free Backup Unit Installation.....	43
7.4	Monitoring the Intel® RAID Maintenance Free Backup Unit.....	45
7.4.1	Monitoring the RMFBU with the Human Interface Infrastructure. ....	45
Appendix A.	Glossary .....	48

## List of Figures

Figure 1 - Intel SAS RSP3TD160F RAID adapter Layout.....	16
Figure 2 - Intel RSP3TD160F RAID adapter Dimensions.....	17
Figure 3 - Intel SAS RSP3DD080F RAID adapter Layout .....	19
Figure 4 - Intel RSP3DD080F RAID adapter Dimensions .....	20
Figure 5 - Intel SAS RSP3MD088F RAID adapter Layout.....	22
Figure 6 - Intel RSP3MD088F RAID adapter Dimensions.....	23
Figure 7 - Intel SAS RSP3WD080E RAID adapter Layout.....	25
Figure 8 - Intel RSP3WD080E RAID adapter Dimensions .....	26
Figure 9. Intel® RSP3TD160F RAID Adapter SFF-8643 connector.....	28
Figure 10. Supported Intel® SAS expander options .....	30
Figure 11. RAID Adapter RMS3PTD160 SAS port domain identification .....	31
Figure 12. SAS ports for the RES3FV288 .....	31
Figure 13. SAS ports for the RES3TV360.....	31
Figure 14. Connecting the AXXCBL700HDCV to the backplane .....	32
Figure 15. Connecting the AXXCBL700HDCV cable to the RAID adapter.....	33
Figure 16 RAID Adapter Installation (insert adapter in slot).....	35
Figure 17 RAID Adapter Installation (insert riser card).....	36
Figure 18 RAID Adapter Installation (adapter installed).....	36
Figure 19. FBU345 layout .....	42
Figure 20. Extender cable pinout.....	43
Figure 21 - AXRMFBU7 Mounting Assembly .....	43
Figure 22 - RMFBU Assembly Installation.....	44
Figure 23 - Connecting the RMFBU7 to the RAID adapter .....	44
Figure 24. HII Dashboard view screen.....	45

Figure 25. HII Hardware Components screen..... 46  
Figure 26. HII Battery Management screen ..... 46

## List of Tables

Table 1. Intel® Tri-Mode RAID adapter comparative feature set ..... 11  
Table 2- Data Protection Features ..... 13  
Table 3. Fault-tolerant features ..... 13  
Table 4. Array performance features ..... 13  
Table 5. SAS/SATA drive support limits ..... 14  
Table 6- UART Connector Pinout ..... 15  
Table 7. SFF-8643 connector pinout ..... 29  
Table 8. FBU345 specifications..... 41

<Blank page>

# 1. Product Overview

---

The Intel® RAID adapters RSP3TD160F, RSP3MD088F, RSP3DD080F and RSP3WD080E are part of the new family of Intel® RAID adapters. This new family of *Tri-Mode* RAID adapters allow for creating RAID configurations with SAS drives, SATA drives, or NVMe drives.

The Intel® RAID adapters RSP3TD160F, RSP3MD088F, RSP3DD080F and RSP3WD080E are high-performance, intelligent adapters with RAID control capability. The Tri-Mode RAID Adapters provide reliability, high-performance, and fault-tolerant drive subsystem management.

The Tri-Mode RAID adapters are based on the LSI SAS IC technology and proven MegaRAID technology. Intel offers a family of Tri-Mode RAID adapters that address the needs for internal connectivity solutions as well as low and high port count:

- RSP3TD160F – Full featured tri-mode RAID adapter with 16 internal ports
- RSP3MD088F– Full featured tri-mode RAID adapter with 8 internal and 8 external ports
- RSP3DD080F– Full featured tri-mode RAID adapter with 8 internal ports
- RSP3WD080E– Entry level tri-mode RAID adapter with 8 internal ports

---

**NOTE:** The Intel Tri-Mode adapters are designed to work on systems configured for optimized UEFI boot mode. There is no built-in configuration utility for these adapters when the system is configured for legacy boot mode. There is no boot support if used in legacy mode. Some adapters like RSP3WD080E will not work at all if used in legacy mode.

---

## 2. Intel® Tri-Mode RAID adapters General Features

---

### 2.1 Overview

The Intel® Tri-Mode adapters include a SAS interface and an NVMe interface. Both share the same connectors by multiplexing the data and sideband signals. As compared with the previous generation of Intel RAID adapters, the new Tri-Mode family offers increased performance by reducing latency, increasing IOPS, increasing queue depth and increasing cache memory. They also offer NVMe drive support to allow doing hardware RAID using these new technology drives.

### 2.2 Benefits of the SAS Interface

SAS is a serial, point-to-point, enterprise-level device interface that leverages the proven SCSI protocol set. SAS is a convergence of the advantages of SATA, SCSI, and Fiber Channel and the mainstay of the enterprise and high-end workstation storage markets.

The SAS interface uses the SCSI command set to ensure reliable data transfers while providing the connectivity and flexibility of point-to-point serial data transfers. The serial transmission of SCSI commands eliminates clock-skew challenges. The SAS interface provides improved performance, simplified cabling, smaller connectors, and lower pin count and power requirements when compared to the original parallel SCSI.

SAS adapters leverage a common electrical and physical connection interface that is compatible with Serial ATA (SATA) technology. The SAS protocols and the SATA III protocols use a common thin, 7-wire connector. The SAS/SATA III connector and cable are easier to manipulate, allow connections to smaller devices, and do not inhibit airflow. The point-to-point SATA III architecture eliminates inherent difficulties created by the legacy ATA master-slave architecture while maintaining compatibility with existing ATA firmware.

### 2.3 Benefits of the NVM Express (NVMe) interface

NVMe (non-volatile memory express) is a storage protocol created to accelerate the transfer of data with solid-state drives (SSDs) by utilizing multiple PCIe connections. Benefits are increased bandwidth (up to 8Gb/s per lane), lower latency, increased efficiency, lower CPU utilization with multiple long command queues and lower power.

### 2.4 Intel® Tri-Mode RAID Adapter Features

Next is an explanation of the features of the Intel® Tri-Mode RAID Adapters.

#### 2.4.1 SAS Features

Characteristics of the SAS interface.

- Supports the following:
  - 12 Gb/s, 6Gb/s, and 3Gb/s SAS data transfers per PHY.
  - SMP communicating topology management information.
  - SSP enabling communication with other SAS devices.
  - STP enabling communication with SATA devices through an attached expander.
- Provides a serial, point-to-point, enterprise-level storage interface.
- Simplifies cabling between devices.
- Provides a scalable interface that supports up to 240 devices through the use of expanders.
- Supports x2 through x8 wide ports that consist of two (2), four (4), or eight(8) PHYs within a single port.
  - Supports narrow ports consisting of a single PHY.
  - Transfers data by using SCSI information units.

## 2.4.2 SATA III Features

The SAS interface is compatible with SATA and it has the following characteristics.

- Supports the following:
  - SATA III data transfers up to 6Gb/s.
  - STP data transfers up to 6Gb/s.
- Provides a serial, point-to-point storage interface.
- Simplifies cabling between devices.
- Eliminates the master-slave construction used in parallel ATA.
- Permits addressing of multiple SATA targets through an expander.

## 2.4.3 NVMe Interface Features

The new NVMe drive interface has the following characteristics.

- Supports the following:
  - Data transfers of 8Gb/s per lane (32 Gb/s when 4 PCIe lanes are being used).
  - *PCI Bus Power Management Interface Specification, Revision 1.2*.
  - Active State Power Management, states, by placing links in a power-saving mode during times of no link activity.
- Supports PCIe Hot Plug.
- Supports error handling.
- Provides high bandwidth per pin with low overhead and low latency.
- Supports lane reversal and polarity inversion.
- 4 PCIe lanes per drive.

## 2.4.4 Usability Features

The Tri-Mode RAID adapters have the next usability characteristics.

- Drives spin-up sequencing control.
- Provides one (1) LED signal to indicate link activity for all PHYs for the the drive activity LED on the chassis.
- Supports the internal SAS sideband signal SFF-8485 (SGPIO) interface.

---

**Note:** LED signals indicate an error condition or drive activity. RAID adapters support several blink patterns for these LEDs, depending on the user configuration and storage enclosure. For information about the LED blink patterns, contact the storage enclosure manufacturer.

---

## 2.4.5 Flexibility Features

The Tri-Mode RAID adapters have the next flexibility characteristics.

- Flash ROM interface, a non-volatile static RAM (NVS RAM) interface.
- Flexible programming interface to tune I/O performance.
- Permit mixed connections to SAS targets or SATA III targets.
- Leverage-compatible connectors for SAS connections and SATA III connections.
- Permit grouping of up to eight (8) PHYs into a single SAS-wide port.
- Permit programming of the World Wide Name.

## 2.4.6 Drive Roaming

Drive roaming occurs when once a VD is already set up, some or all of the drives that are part of this VD are manually changed to different ports on the same adapter. When this happens, the adapter detects the RAID configuration from the configuration data on the drives.

Configuration data is saved in both the NVRAM on the RAID adapter and on the drives attached to the adapter. This feature maintains the integrity of the data on each drive, even if the drives have changed their physical

device ID. More information on how to use the drive roaming feature can be found on the Intel® RAID Software User Guide for full featured and entry level RAID adapters.

#### **2.4.7 Drive Migration**

The Intel® Tri-Mode RAID adapters allow to move one VD from one adapter to another, this is called Drive Migration. In other words, Drive Migration is the transfer of a set of drives in an existing configuration from one adapter to another. In order to achieve this, there are some conditions: 1) The drives must remain on the same channel. 2) The drives must be reinstalled in the same order as in the original configuration. 3) The adapter to which the drives are migrated cannot have an existing configuration.

---

**Note:** When drives are migrated, move only the drives that make up the virtual drive (not all of the drives in a drive group), so that an NVRAM mismatch error does not occur (provided a configuration is on the destination adapter). The NVRAM mismatch error appears only when all of the drives are moved to the other adapter.

**Note:** Drive roaming and drive migration cannot be supported at the same time.

---

More information on how to use the drive migration feature can be found on the Intel® RAID Software User Guide for full featured and entry level RAID adapters.

#### **2.4.8 Safety Characteristics**

All the Intel® Tri-Mode RAID adapters meet or exceed the requirements of UL flammability rating 94 V0. Each bare board is also marked with the supplier name or trademark, type, and UL flammability rating.



## 2.5 Intel® Tri-Mode RAID adapters Feature Set.

The following table describes the feature set of the Intel Tri-Mode adapters

**Table 1. Intel® Tri-Mode RAID adapter comparative feature set**

Feature	RSP3TD160F	RSP3MD088F	RSP3DD080F	RSP3WD080E
I/O Processor	Broadcom* SAS3516 PCIe* RAID On-Chip (ROC)	Broadcom* SAS3516 PCIe* RAID On-Chip (ROC)	Broadcom* SAS3508 PCIe* RAID On-Chip (ROC)	Broadcom* SAS3408 PCIe* RAID On-Chip (ROC)
RAID Levels	0,1,5,6,10, 50, 60	0,1,5,6,10, 50, 60	0,1,5,6,10, 50, 60	0,1,5,10,50
JBOD Mode or Pass-thru mode (SAS/SATA)	Yes	Yes	Yes	Yes
Cache Memory	4 GB DDR4 at 2133 MHz	4 GB DDR4 at 2133 MHz	4 GB DDR4 at 2133 MHz	N/A
Form Factor	MD2 (PCIe card)	MD2 (PCIe card)	MD2 (PCIe card)	MD2 (PCIe card)
Drive Interface Connectors	4 internal	2 internal, 2 external	2 internal	2 internal
PCIe* Interface	x8 PCI Express* 3.0. PCIe Performance up to 8 GT/s per lane	x8 PCI Express* 3.0. PCIe Performance up to 8 GT/s per lane	x8 PCI Express* 3.0. PCIe Performance up to 8 GT/s per lane	x8 PCI Express* 3.0. PCIe Performance up to 8 GT/s per lane
Data Transfer Rates	12, 6, & 3 Gbps per port SAS, 6 & 3 Gbps per port SATA and 8 Gbps per lane NVMe	12, 6, & 3 Gbps per port SAS, 6 & 3 Gbps per port SATA and 8 Gbps per lane NVMe	12, 6, & 3 Gbps per port SAS, 6 & 3 Gbps per port SATA and 8 Gbps per lane NVMe	12, 6, & 3 Gbps per port SAS, 6 & 3 Gbps per port SATA and 8 Gbps per lane NVMe
Maximum Operating Temperature (chassis internal)	55°C	55°C	55°C	55°C
Operating System	Microsoft Window*, Linux* (SuSE*, Red Hat*) Solaris* FreeBSD*	Microsoft Window*, Linux* (SuSE*, Red Hat*) Solaris* FreeBSD*	Microsoft Window*, Linux* (SuSE*, Red Hat*) Solaris* FreeBSD*	Microsoft Window*, Linux* (SuSE*, Red Hat*) Solaris* FreeBSD*
Drive Types	SAS, SATA, NVMe	SAS, SATA, NVMe****	SAS, SATA, NVMe	SAS, SATA, NVMe
Maximum NVMe drives supported	4	2****	2	2
Maximum SAS/SATA devices supported**	240***	240***	240***	63
Maximum Virtual Drives	240***	240***	240***	32
Advanced array configuration and management utilities	Yes	Yes	Yes	Yes
Support for global hot spares and dedicated hot spares	Yes	Yes	Yes	Only global hot spares
Support for user-defined strip sizes: 64, 128, 256, 512, or 1024 KB	Yes	Yes	Yes	No
Advanced array configuration and	Yes	Yes	Yes	No

management utilities offer these capabilities: <ul style="list-style-type: none"> <li>• Online capacity expansion</li> <li>• Online RAID level migration</li> <li>• Drive migration</li> <li>• Drive roaming</li> <li>• No reboot necessary after expansion</li> <li>• Media scan</li> </ul>				
User-specified rebuild rate (specifying the percentage of system resources to use from 0 percent to 100 percent)	Yes	Yes	Yes	No
Nonvolatile random access memory (NVRAM) of 32 KB for storing RAID system configuration information; the MegaRAID SAS firmware is stored in flash ROM for easy upgrade.	Yes	Yes	Yes	Yes
Support for RAID Maintenance Free Backup Unit (RMFBU). Used to save RAID Cache in event of unexpected power loss	Yes Intel accessory AXSRMFBU7 – (Option)	Yes Intel accessory AXSRMFBU7 – (Option)	Yes Intel accessory AXSRMFBU7 – (Option)	No
Self-Encrypting Drive Support, SAS and SATA	TCG Enterprise only	TCG Enterprise only	TCG Enterprise only	No
Self-Encrypting Drive Support, NVMe	TCG Enterprise and OPAL	TCG Enterprise and OPAL	TCG Enterprise and OPAL	No
SSD Cache Support	No	No	No	No
Snapshot Recovery	No	No	No	No
MTBF(hours)	2,820,874	2,832,059	2,977,077	6,211,180
Standard Warranty	3 years, AWR options	3 years, AWR options	3 years, AWR options	3 years, AWR options

\*\* Devices include drives and expanders. Drives on Dual-ported backplanes count twice.

\*\*\* This number is profile dependent.

\*\*\*\* NVMe drives are only supported on the internal connectors.

## 2.6 Data Protection Features

The next table describes the Data protection features of the Intel® Tri-Mode RAID adapters.

**Table 2- Data Protection Features**

Feature	RSP3TD160F	RSP3MD088F	RSP3DD080F	RSP3WD080E
On-line Capacity Extension	Yes	Yes	Yes	Yes
Distributed Sparing	Yes	Yes	Yes	No
Background Consistency Checking	Yes	Yes	Yes	Yes
Patrol Read for Media Functionality	Yes	Yes	Yes	Yes
S.M.A.R.T Support	Yes	Yes	Yes	Yes
Enclosure Management	Yes	Yes	Yes	Yes
RAID Support Before Operating System Loaded	Yes	Yes	Yes	Yes
Write Back Cache with optional Protection	Yes	Yes	Yes	No
Intel® RAID Management Software	Yes	Yes	Yes	Yes
Hot-Spare Support, Global & Dedicated	Yes	Yes	Yes	Only Global

## 2.7 Fault Tolerance Features

The next table describes the Fault-tolerant features of the Intel® Tri-Mode RAID adapters

**Table 3. Fault-tolerant features**

Specification	RSP3TD160F	RSP3MD088	RSP3DD080F	RSP3WD080E
Support for SMART <sup>A</sup>	Yes	Yes	Yes	Yes
Drive failure detection	Automatic	Automatic	Automatic	Automatic
Drive rebuild using hot spares	Automatic	Automatic	Automatic	Automatic
Parity generation and checking	Yes	Yes	Yes	Yes

<sup>1</sup> The Self-Monitoring Analysis and Reporting Technology (SMART) detects up to 70 percent of all predictable drive failures. In addition, SMART monitors the internal performance of all motors, heads, and drive electronics.

## 2.8 Array Performance Features

The next table describes the Array performance features of the Intel® Tri-Mode RAID adapters

**Table 4. Array performance features**

Specification	RSP3TD160F	RSP3MD088F	RSP3DD080F	RSP3WD080E
PCI Express host data transfer	8GT/s per lane	8GT/s per lane	8GT/s per lane	8GT/s per lane
Drive data transfer rate	12, 6, 3 Gb/s (SAS) 6,3,1.5 Gb/s (SATA) 8 Gb/s per lane (NVMe)	12, 6, 3 Gb/s (SAS) 6,3,1.5 Gb/s (SATA) 8 Gb/s per lane (NVMe)	12, 6, 3 Gb/s (SAS) 6,3,1.5 Gb/s (SATA) 8 Gb/s per lane (NVMe)	12, 6, 3 Gb/s (SAS) 6,3,1.5 Gb/s (SATA) 8 Gb/s per lane (NVMe)

Maximum scatter/gather I/O	80 elements	80 elements	80 elements	60 elements
Maximum size of I/O requests	6.4 MB in 64-KB strips	6.4 MB in 64-KB strips	6.4 MB in 64-KB strips	6.4 MB in 64-KB strips
Maximum queue tags per drive	As many as the drive can accept	As many as the drive can accept	As many as the drive can accept	As many as the drive can accept
Strip sizes	64 KB, 128 KB, 256 KB, 512 KB, or 1 MB	64 KB, 128 KB, 256 KB, 512 KB, or 1 MB	64 KB, 128 KB, 256 KB, 512 KB, or 1 MB	64K

## 2.9 Drive Support Limits

The next table describes the SAS/SATA drive support limits of the Intel® Tri-Mode RAID adapters

**Table 5. SAS/SATA drive support limits**

Specification	RSP3TD160F	RSP3MD088F	RSP3DD080F	RSP3WD080E
Maximum virtual drives per adapter	240***	240***	240***	32
Maximum drive groups per adapter	240	240	240	32
Maximum virtual drives per drive group	16	16	16	16
Maximum drives per drive group	32	32	32	32
Maximum physical devices per adapter	240***	240***	240***	63
Maximum hot spares per adapter	64	64	64	63
Maximum spans per virtual drive	8	8	8	8
Maximum enclosures	10***	10***	10***	2***

\*\*\* This setting is profile dependent.

## 2.10 Over temperature protection

The Intel® Tri-Mode RAID adapters are designed to operate at a maximum internal chassis temperature of 55 degrees Celsius, with a minimum of 200 LFM air flow, this ensures the internal ROC IC will operate at less than 105 Celsius. If for any reason there's an overheating, the internal ROC over temperature protection circuitry will operate like this:

- If the ROC reaches 110 degrees Celsius, the over temperature LED is turned on, I/O is throttled and the event "MR\_EVT\_CTRL\_TEMP\_ABOVE\_OPTIMAL\_RANGE" is be registered in the adapter's log.
- If the ROC temperature goes down below 105 degrees Celsius (mostly due to I/O throttling), the over temperature LED is turned off, the event "MR\_EVT\_CTRL\_TEMP\_WITHIN\_OPTIMAL\_RANGE" is registered in the adapter's log and I/O throttling is turned off.
- If the ROC reaches 116 degrees Celsius, the over temperature LED continues to lit, I/O continues to throttle, the event "MR\_EVT\_CTRL\_TEMP\_CRITICAL " is registered in the adapter's log, then after 10 seconds of operation the cache is flushed, pending I/Os are completed and the ROC enters into the "Montask" state, in which state all I/Os stop except through the UART debugging interface.

## 2.11 UART Interface

The Intel® Tri-Mode RAID adapters include a UART interface for special debugging purposes. The UART connector debug port requires a special cable and Intel support to gather detailed ROC/IOC status. The UART connector uses the layout shown in the following table.

**Table 6- UART Connector Pinout**

Pin	Function
1	UART_TX
2	Gnd
3	UART_RX
4	1.8 V

The default communication parameters are 115,200 b/s, 8-bit characters, no parity bit, one stop bit, and no XON/XOFF flow control.

## 2.12 Optional Intel® RAID Maintenance Free Backup Unit (RMFBU)

To protect the integrity of cached data on the Intel® RAID Adapter during a power loss event, the Intel Tri-Mode Adapter RSP3TD160F and RSP3DD080F provide support for the Intel® Maintenance Free Backup Unit (RMFBU – Intel Accessory Kit **AXXRMFBU7**). During a power loss event, this optional accessory provides back-up power to the RAID Adapter, allowing the adapter to offload the data stored in the its onboard cache to its on-board non-volatile NAND flash.

Benefits of the RMFBU option include:

- Capacitor technology has a longer usable life span than batteries, and reduces maintenance and replacement costs
- Capacitors do not have the chemical volatility of batteries which carry a risk of exothermic events
- RMFBU options do not require the comprehensive certifications required of batteries in order to import and export them
- The RMFBU can constantly maintain the RAID volume in write back mode even when doing learn cycles
- The recharge rate of the super-capacitor is minutes as compared to hours for a battery

See Chapter 7 for additional RMFBU information.

### 3. Intel® Tri-Mode RAID Adapters Detailed Characteristics

#### 3.1 Intel RAID Adapter RSP3TD160F Description

The Intel® RAID adapter RSP3TD160F is a full featured tri-mode RAID adapter with 16 internal ports based on the Avago® SAS3516 RAID-On-Chip (ROC). It supports RAID levels 0, 1, 5,6,10, 50, 60 and includes 4 GB of 72-bit cache memory DDR4 at 2133 MHz. It has an x8 PCI Express\* 3.0. PCIe interface and it supports up to 240 physical SAS.SATA devices\*\* and up to 240 virtual drives. It also supports up to 4 direct attach NVMe drives. This adapter has a connector to install the Drive Encryption Premium Key. The next figures describe the connectors for this adapter.

\*\* Physical devices include expanders and if dual-ported back planes are being used, each drive counts twice.

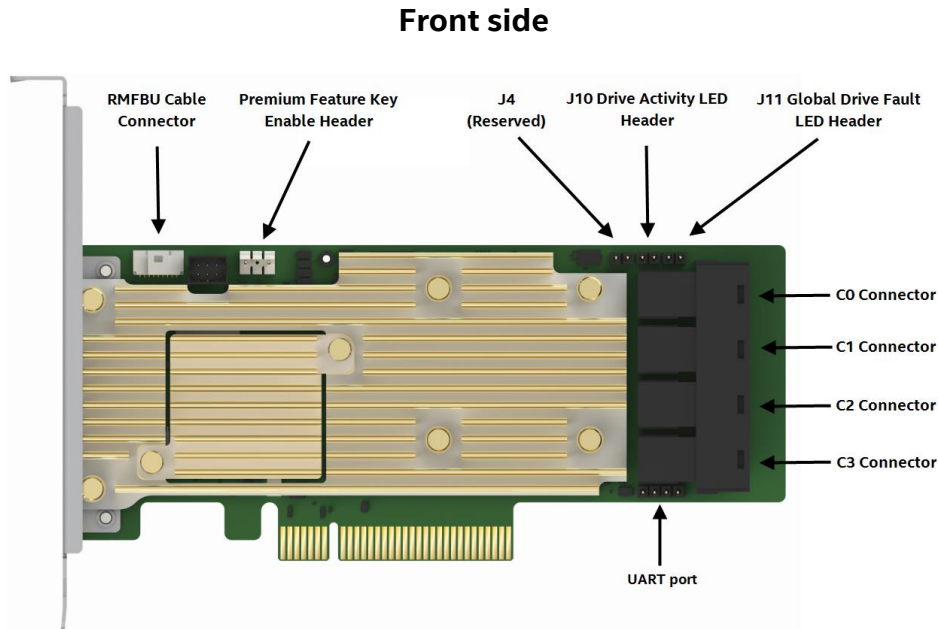

**Back side**

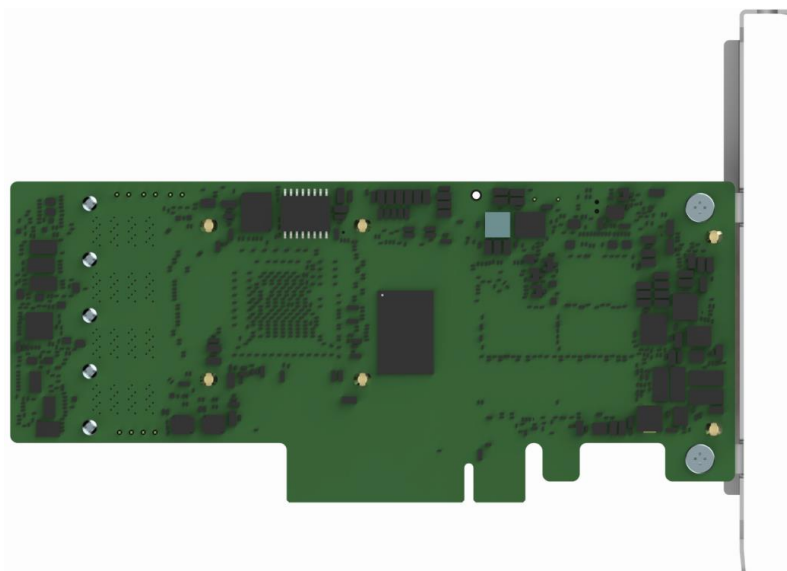

Figure 1 - Intel SAS RSP3TD160F RAID adapter Layout

### 3.2 Intel RAID Adapter RSP3TD160F Dimensions

The next figure show the dimensions for the Intel RAID Adapter RSP3TD160F.

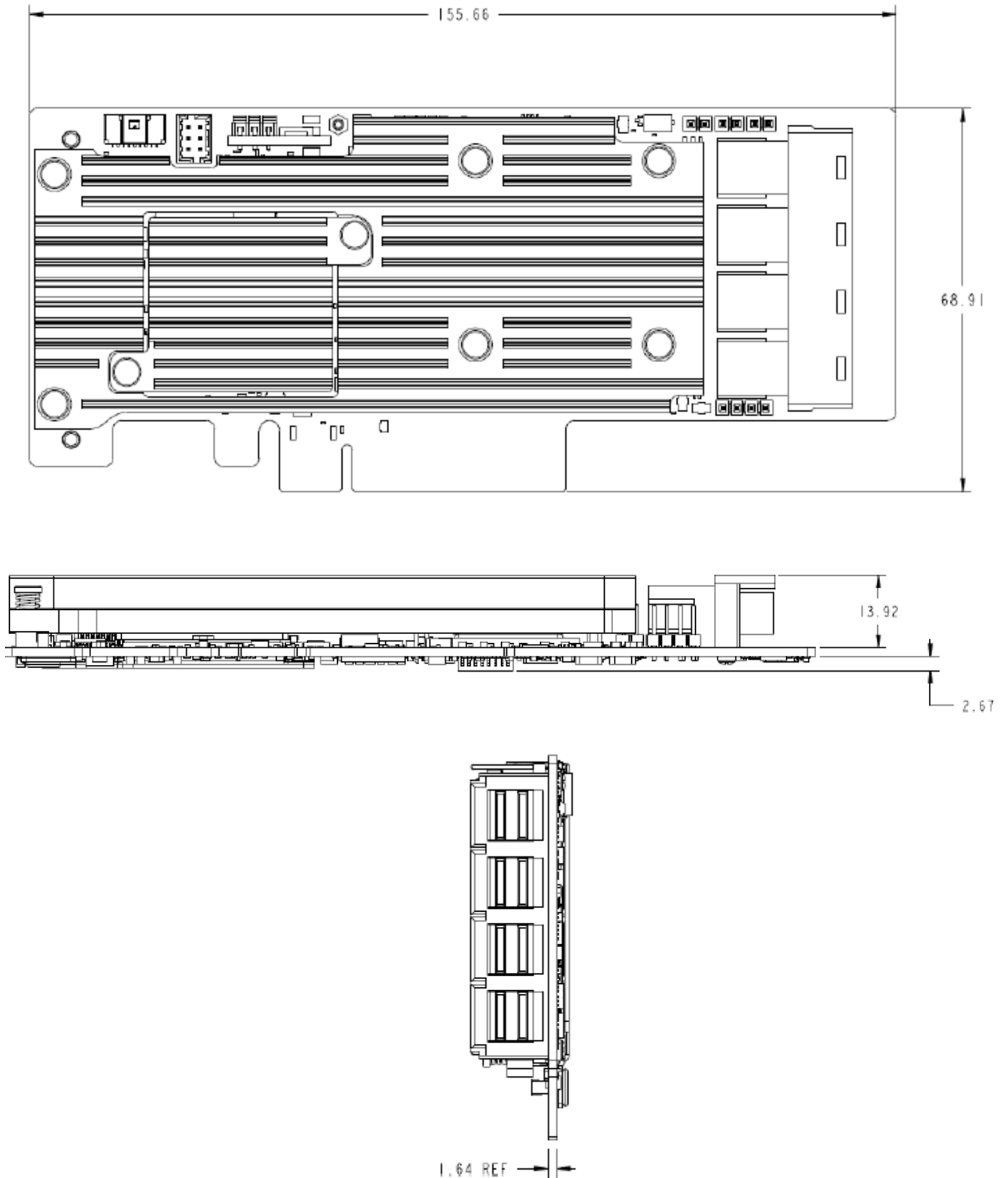

Figure 2 - Intel RSP3TD160F RAID adapter Dimensions

### 3.2.1 Intel RAID Adapter RSP3TD160F Electrical, Thermal and Atmospheric Requirements.

List of operating conditions for the Intel® RAID adapter RSP3TD160F:

- Power Supply voltage at the 12V rail (from PCI edge connector): 12V ± 8 percent.
- Power Supply voltage at the 3.3V rail (from PCI edge connector): 13.3V ± 9 percent.
- Relative humidity range is 20 percent to 80 percent non-condensing
- Temperature range: 0 °C to +55 °C (with or without the RMFBU Adapter attached)

List of non-operating conditions (while in storage or in transit) for the Intel® RAID adapter RSP3TD160F:

- Relative humidity range is 5 percent to 90 percent non-condensing.
- Temperature range: –45°C to +105°C without battery backup unit
- Temperature range: 0°C to +70°C with battery backup unit

### 3.2.2 Intel RAID Adapter RSP3TD160F Power Consumption.

The following table describes the power consumption of the Intel® RAID adapter RSP3TD160F under the following states:

State 1: While sitting idle at the DOS prompt or the EFI shell.

State 2: During a drive stress test; average over 20 minutes of sustained operation

Power Mode	State 1	State 2	
	Typical	Typical	RMFBU learn
<b>3.3V Supply</b>	0.24W	0.28W	6W
<b>+ 12 Supply</b>	16.4W	16.7W	
<b>3.3V Auxillary Supply</b>	0.03W	0.08W	
<b>Total Power</b>	16.67W	17.06W	6W



### 3.3 Intel RAID Adapter RSP3DD080F

The Intel® RAID Adapter RSP3DD080F is a full featured tri-mode RAID adapter with 8 internal ports based on the Avago® SAS3508 RAID-On-Chip (ROC). It supports RAID levels 0, 1, 5,6,10, 50, 60 and includes 4 GB of 72-bit cache memory DDR4 at 2133 MHz. It has an x8 PCI Express\* 3.0. PCIe interface and it supports up to 240 physical SAS/SATA devices\*, 2 direct attach NVMe drives and up to 240 virtual drives\*\*. This adapter has a connector to install the Drive Encryption Premium Key. The next figure describes the connectors for this adapter.

\*\* Physical devices include expanders and if dual-ported back planes are being used, each drive counts twice.

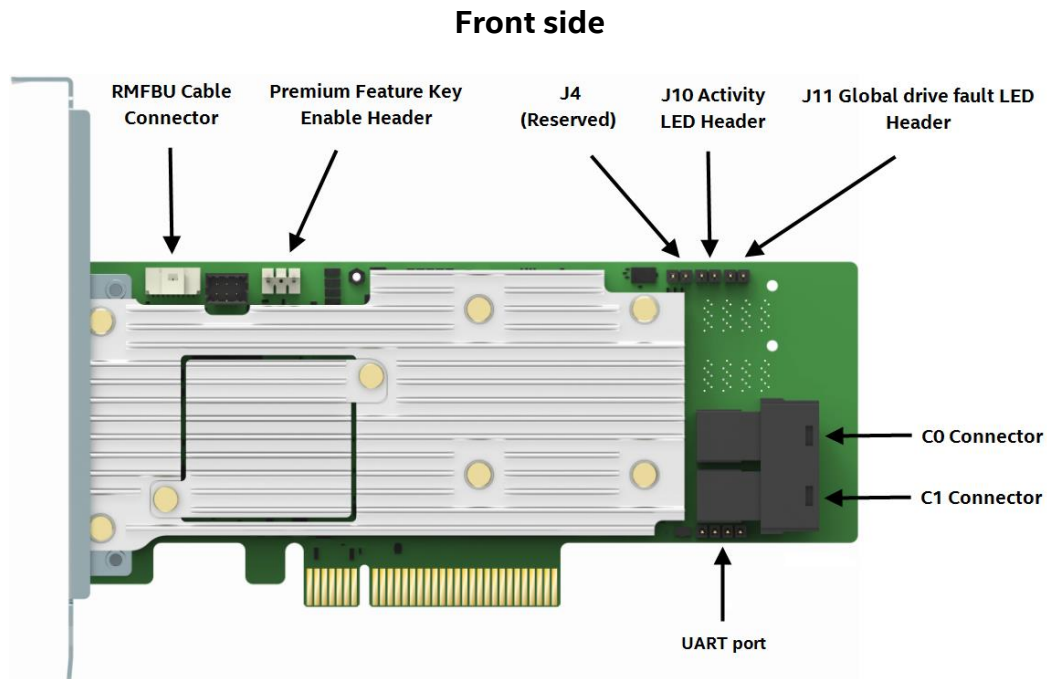

**Back side**

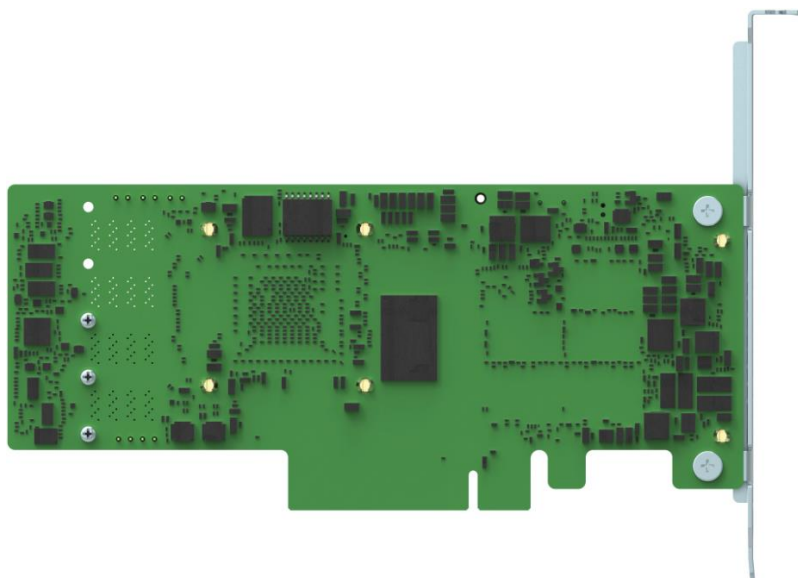

**Figure 3 - Intel SAS RSP3DD080F RAID adapter Layout**

### 3.4 Intel RAID Adapter RSP3DD080F Dimensions

The next figure shows the dimensions for the Intel RAID Adapter RSP3DD080F in millimeters.

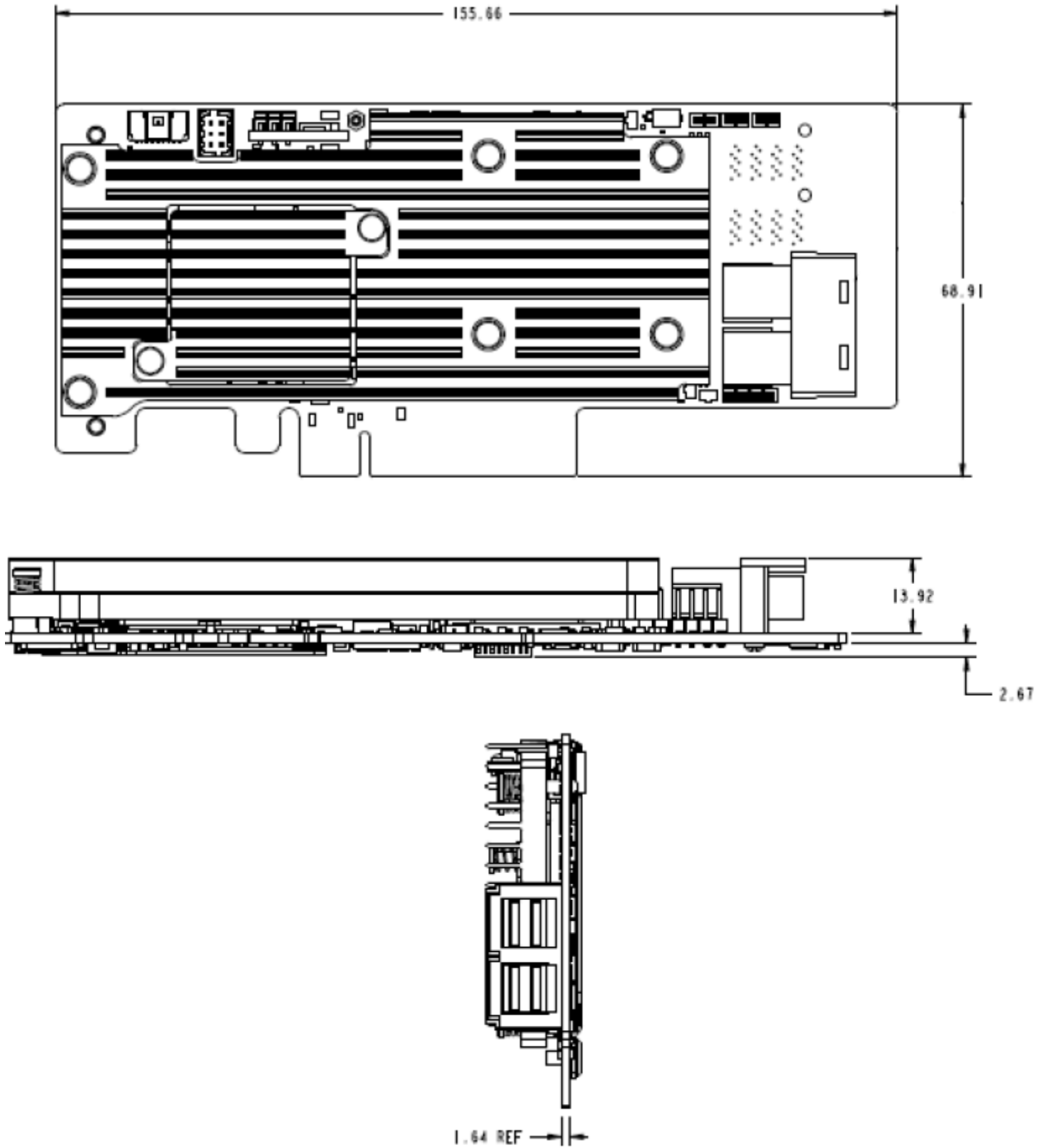

Figure 4 - Intel RSP3DD080F RAID adapter Dimensions

### 3.4.1 Intel RAID Adapter RSP3DD080F Electrical, Thermal and Atmospheric Requirements.

List of operating conditions for the Intel® RAID adapter RSP3DD080F:

- Power Supply voltage at the 12V rail (from PCI edge connector): 12V ± 8 percent.
- Power Supply voltage at the 3.3V rail (from PCI edge connector): 13.3V ± 9 percent.
- Relative humidity range is 20 percent to 80 percent non-condensing
- Temperature range: 0 °C to +55 °C (with or without the RMFBU Adapter attached)

List of non-operating conditions (while in storage or in transit) for the Intel® RAID adapter RSP3DD080F:

- Relative humidity range is 5 percent to 90 percent non-condensing.
- Temperature range: –45°C to +105°C without battery backup unit
- Temperature range: 0°C to +70°C with battery backup unit

### 3.4.2 Intel RAID Adapter RSP3DD080F Power Consumption.

The following table describes the power consumption of the Intel® RAID adapter RSP3DD080F under the following states:

State 1: While sitting idle at the DOS prompt or the EFI shell.

State 2: During a drive stress test; average over 20 minutes of sustained operation

Power Mode	State 1	State 2	
	<b>Typical</b>	<b>Typical</b>	RMFBU learn
<b>3.3V Supply</b>	0.24W	0.28W	6W
<b>+ 12 Supply</b>	13.56W	13.80W	
<b>3.3V Auxillary Supply</b>	0.03W	0.08W	
<b>Total Power</b>	13.83W	14.16W	6W

### 3.5 Intel RAID Adapter RSP3MD088F

The Intel® RAID Adapter RSP3MD088F is a full featured tri-mode RAID adapter with 8 internal ports and 8 external ports, based on the Avago® SAS3516 RAID-On-Chip (ROC). It supports RAID levels 0, 1, 5,6,10, 50, 60 and includes 4 GB of 72-bit cache memory DDR4 at 2133 MHz. It has an x8 PCI Express\* 3.0. PCIe interface, it supports up to 240 physical SAS/SATA devices\*, and up to 240 virtual drives\*\*. This adapter has a connector to install the Drive Encryption Premium Key. The next figure describes the connectors for this adapter.

\*\* Physical devices include expanders and if dual-ported back planes are being used, each drive counts twice.

#### Top side

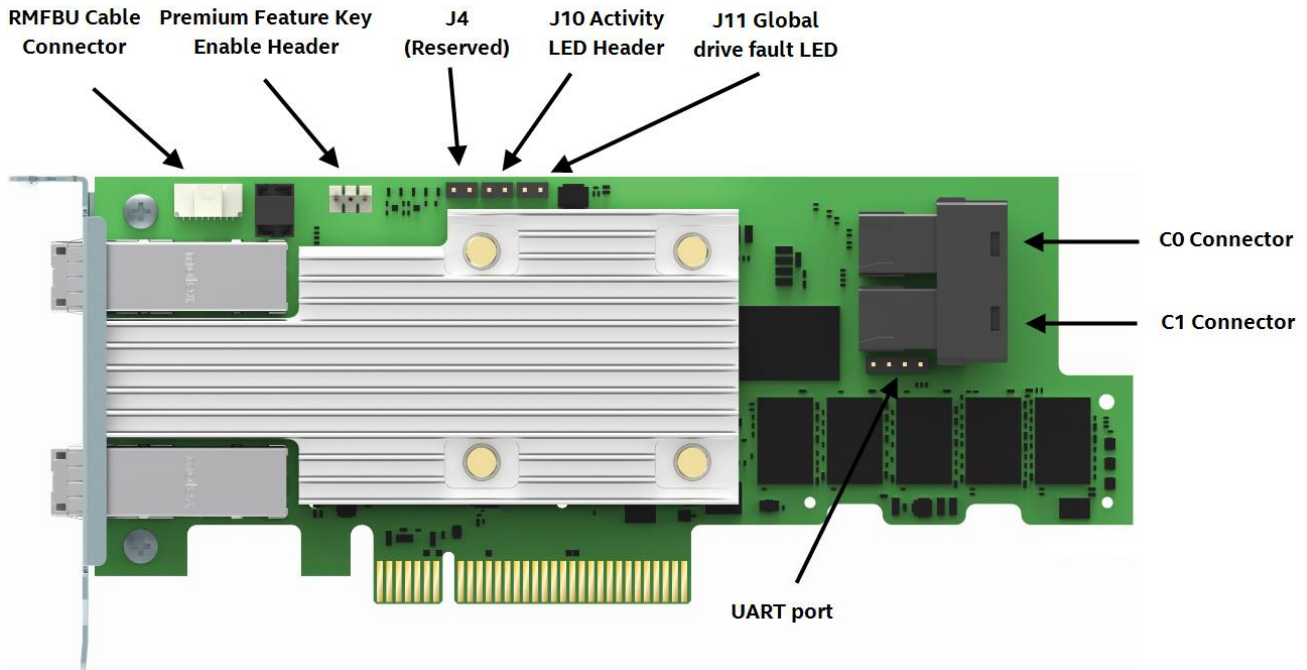

#### Bottom side

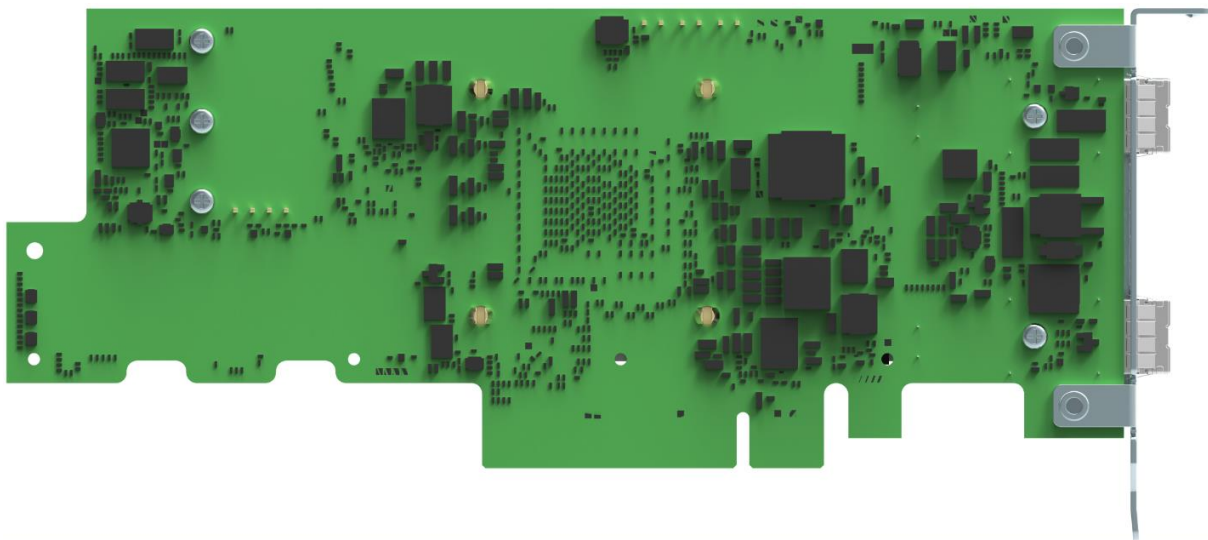

Figure 5 - Intel SAS RSP3MD088F RAID adapter Layout

### 3.6 Intel RAID Adapter RSP3MD088F Dimensions

The next figure shows the dimensions for the Intel RAID Adapter RSP3MD088F in millimeters.

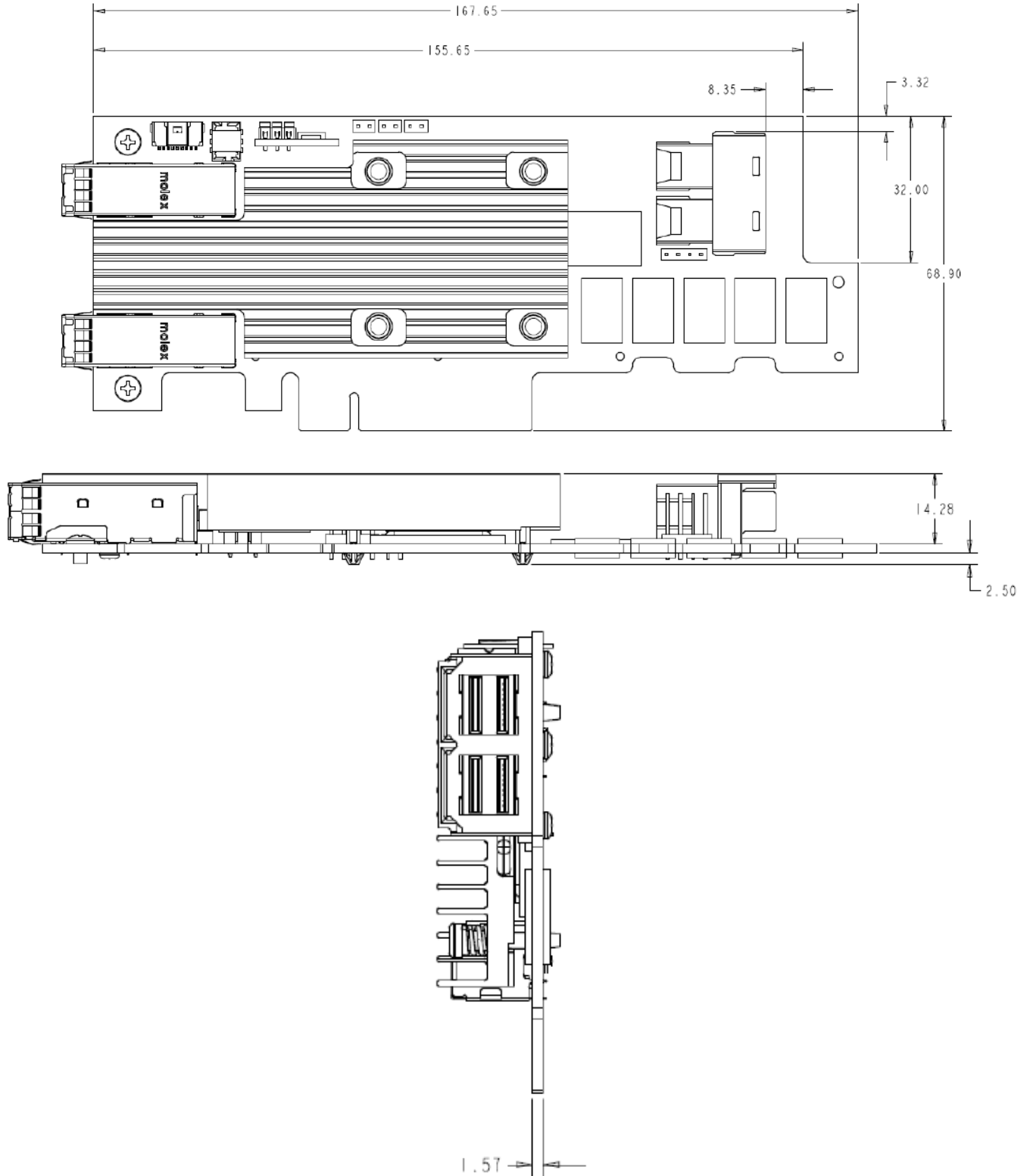

Figure 6 - Intel RSP3MD088F RAID adapter Dimensions

### 3.6.1 Intel RAID Adapter RSP3MD088F Electrical, Thermal and Atmospheric Requirements.

List of operating conditions for the Intel® RAID adapter RSP3MD088F:

- Power Supply voltage at the 12V rail (from PCI edge connector): 12V ± 8 percent.
- Power Supply voltage at the 3.3V rail (from PCI edge connector): 13.3V ± 9 percent.
- Relative humidity range is 20 percent to 80 percent non-condensing
- Temperature range: 0 °C to +55 °C (with or without the RMFBU Adapter attached)

List of non-operating conditions (while in storage or in transit) for the Intel® RAID adapter RSP3MD088F:

- Relative humidity range is 5 percent to 90 percent non-condensing.
- Temperature range: –45°C to +105°C without battery backup unit
- Temperature range: 0°C to +70°C with battery backup unit

### 3.6.2 Intel RAID Adapter RSP3MD088F Consumption.

The following table describes the power consumption of the Intel® RAID adapter RSP3MD088F under the following states:

State 1: While sitting idle at the DOS prompt or the EFI shell.

State 2: During a drive stress test; average over 20 minutes of sustained operation

Power Mode	State 1	State 2	
	Typical	Typical	RMFBU learn
<b>3.3V Supply</b>	0.23W	0.20W	6W
<b>+ 12 Supply</b>	16.40W	17.48W	
<b>3.3V Auxillary Supply</b>	0.07W	0.03W	
<b>Total Power</b>	16.70W	17.71W	6W

### 3.7 Intel RAID Adapter RSP3WD080E

The Intel® RAID Adapter RSP3WD080E is an entry level tri-mode RAID adapter with 8 internal ports based on the Avago® SAS3408 SAS I/O Controller (IOC). It supports RAID levels 0, 1, 10 and hybrid 5. It has an x8 PCI Express\* 3.0. PCIe interface and it supports up to 63 physical devices\* and up to 32 virtual drives\*\*. The next figure describes the connectors for this adapter.

\*\* Physical devices include expanders and if dual-ported back planes are being used, each drive counts twice.

#### Top side

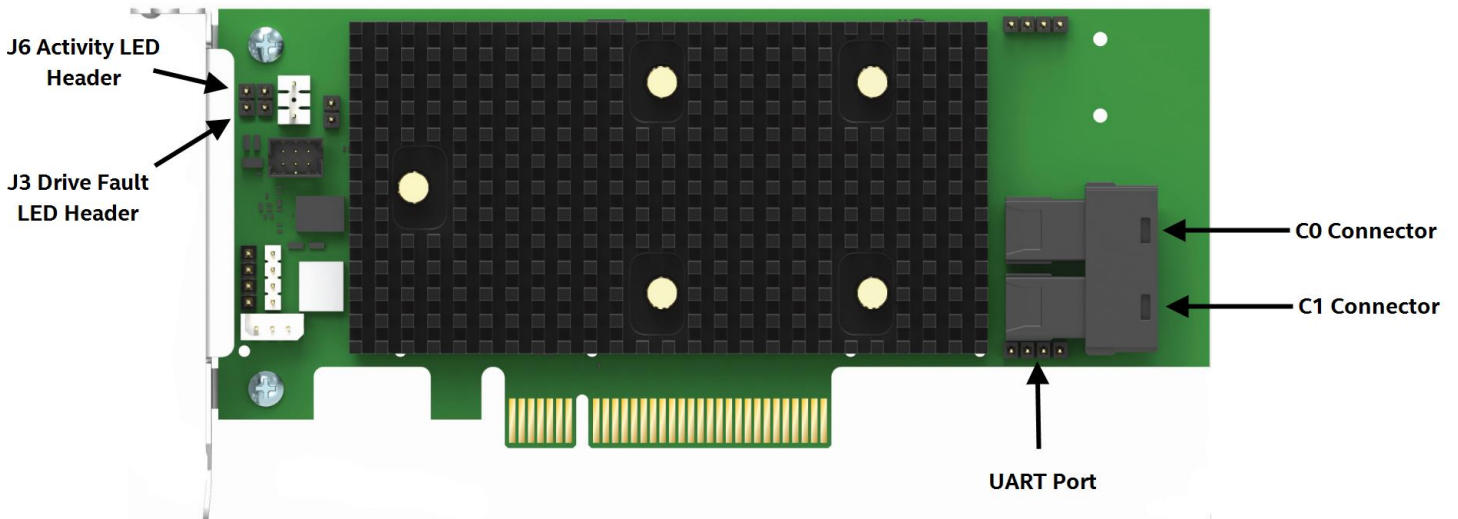

#### Bottom side

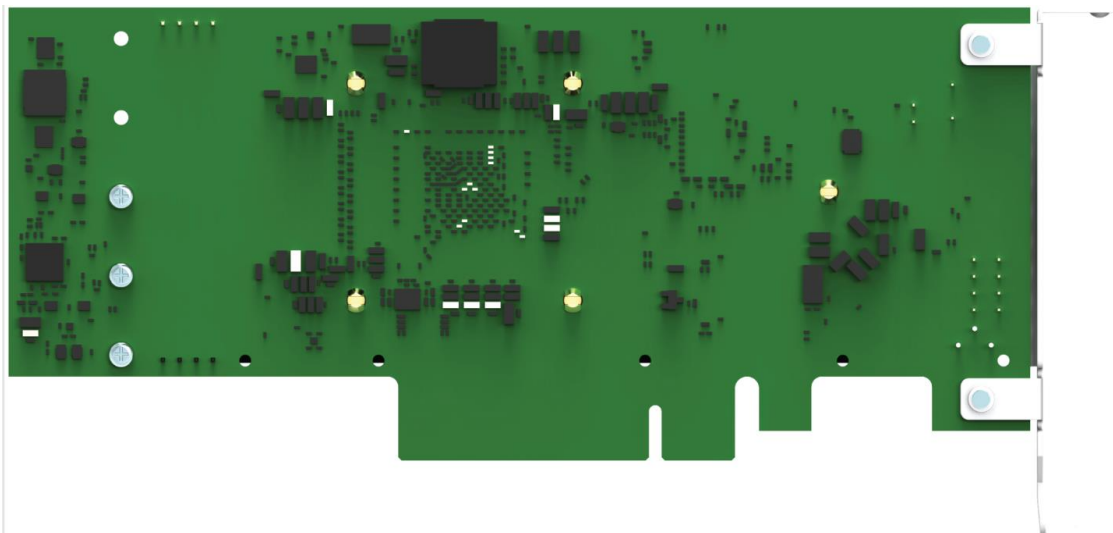

Figure 7 - Intel SAS RSP3WD080E RAID adapter Layout

### 3.8 Intel RAID Adapter RSP3WD080E Dimensions

The next figure shows the dimensions for the Intel RAID Adapter RSP3WD080E in millimeters.

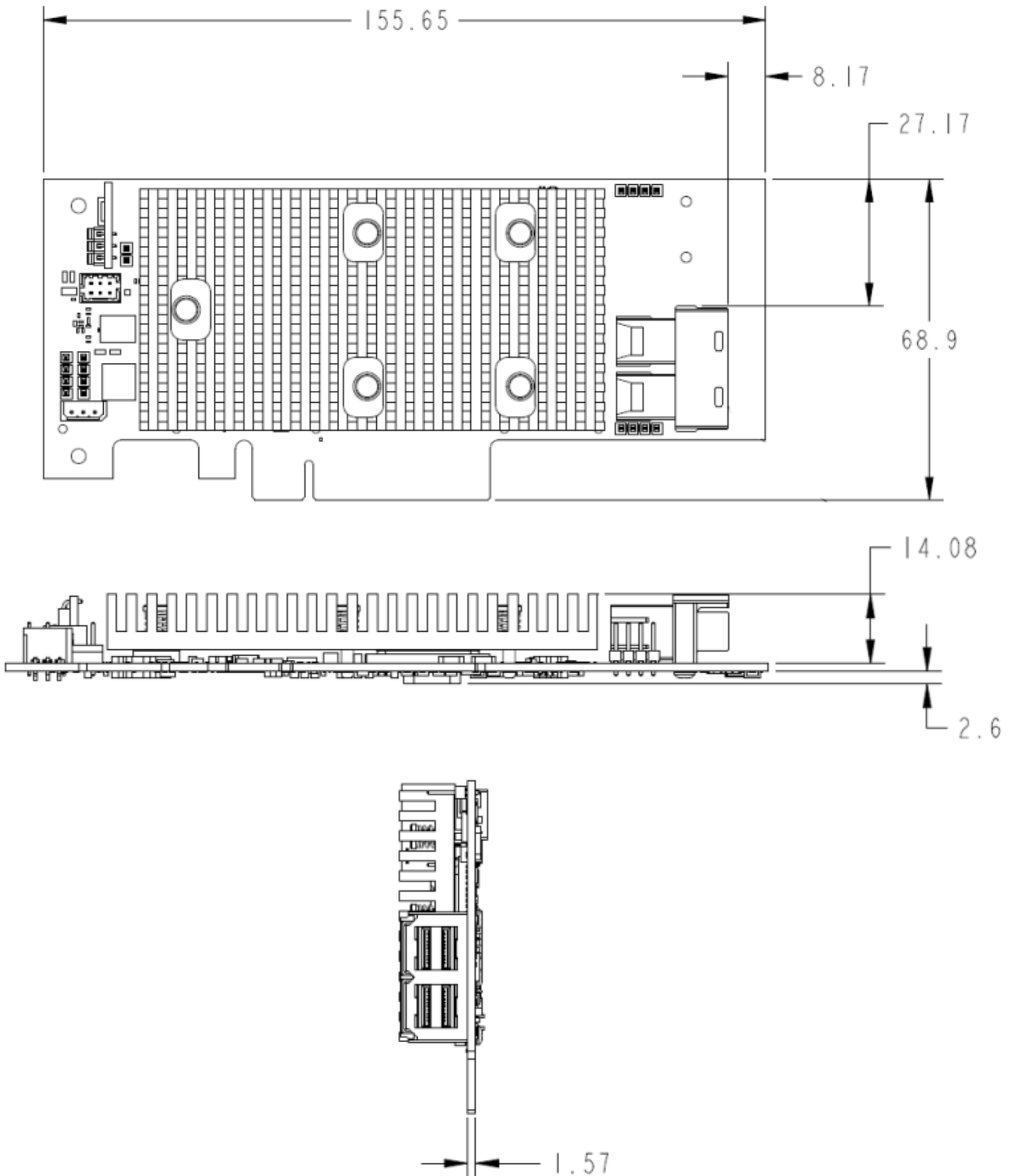

Figure 8 - Intel RSP3WD080E RAID adapter Dimensions



**3.8.1 Intel RAID Adapter RSP3WD080E Electrical, Thermal and Atmospheric Requirements.**

List of operating conditions for the Intel® RAID adapter RSP3WD080E:

- Power Supply voltage at the 12V rail (from PCI edge connector): 12V ± 8 percent.
- Power Supply voltage at the 3.3V rail (from PCI edge connector): 3.3V ± 9 percent.
- Relative humidity range is 20 percent to 80 percent non-condensing
- Temperature range: 0 °C to +55 °C

List of non-operating conditions (while in storage or in transit) for the Intel® RAID adapter RSP3WD080E:

- Relative humidity range is 5 percent to 90 percent non-condensing.
- Temperature range: –45°C to +105°C.

**3.8.2 Intel RAID Adapter RSP3WD080E Power Consumption.**

The following table describes the power consumption of the Intel® RAID adapter RSP3WD080E under the following states:

State 1: While sitting idle at the DOS prompt or the EFI shell.

State 2: During a drive stress test; average over 20 minutes of sustained operation

Power Mode	State 1	State 2	
	Typical	Typical	RMFBU learn
<b>3.3V Supply</b>	1.6W	1.6W	N/A
<b>+ 12 Supply</b>	8.26W	8.42W	
<b>3.3V Auxillary Supply</b>	0.03W	0.03W	
<b>Total Power</b>	9.89W	10.05W	N/A

## 4. Connectivity and Drive Support

### 4.1 Connectivity and Drive Support

The Intel® Tri- Mode RAID Adapters have standard female SFF-8643 (Mini-SAS High-Density) connectors to connect the drives and are designed for the Intel® Server Boards and Systems for the next-generation Intel® Xeon® processor product family. Those systems have the appropriate backplane capable of supporting SAS, SATA and NVMe drives.

### 4.2 Connector Pinout

The Intel® Tri- Mode RAID Adapters have standard female SFF-8643 (Mini-SAS High-Density) connectors to connect to drives. The connector pinout follows the SFF-9402 specification. SFF-9402 defines how to share sideband signals between SAS and PCI Express (NVMe).

When SAS/SATA drives are connected either as a direct attach through an SFF-8680 bay or through an enclosure, existing 12Gb/s SAS cables and mid-plane connector designs are supported by the RAID Adapter. The next figure shows the pinout for the female SFF-8643 connectors on the adapter cards.

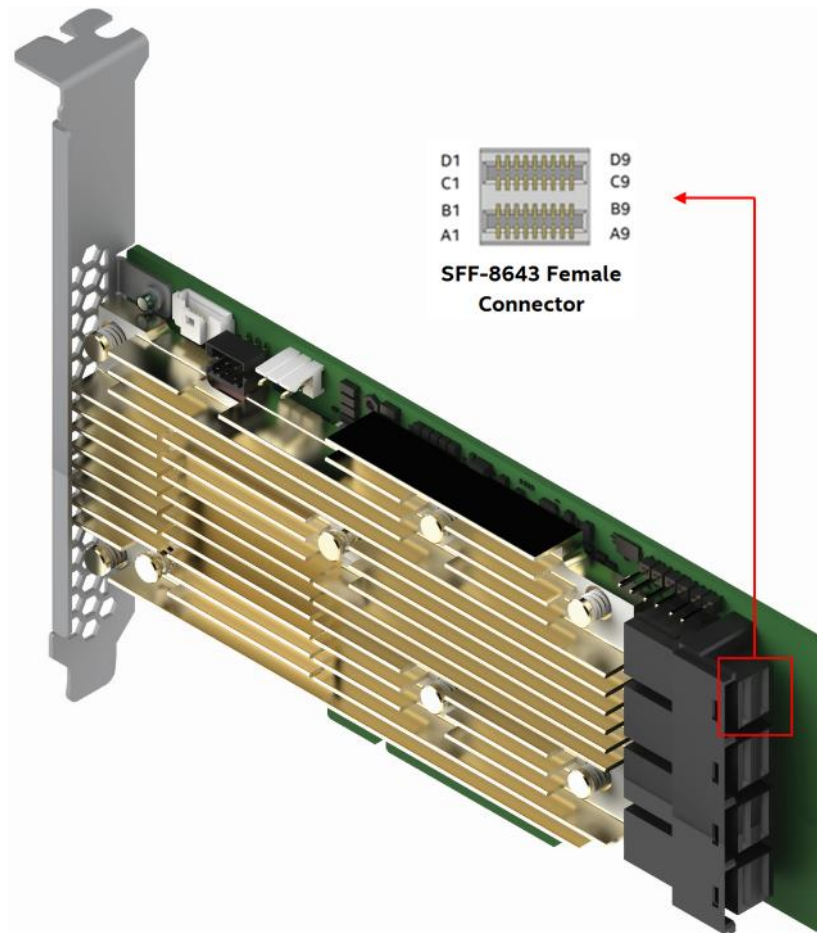

Figure 9. Intel® RSP3TD160F RAID Adapter SFF-8643 connector

**Table 7. SFF-8643 connector pinout**

Pin#	Signal Name	Pin#	Signal Name	Pin#	Signal Name	Pin#	Signal Name
A1	SB7	B1	SB3 GND	C1	SB4	D1	SB5
A2	SB0	B2	SB1	C2	SB2	D2	SB6
A3	GND	B3	GND	C3	GND	D3	GND
A4	RX1+	B4	RX0+	C4	TX1+	D4	TX0+
A5	RX1-	B5	RX0-	C5	TX1-	D5	TX0-
A6	GND	B6	GND	C6	GND	D6	GND
A7	RX3+	B7	RX2+	C7	TX3+	D7	TX2+
A8	RX3-	B8	RX2-	C8	TX3-	D8	TX2-
A9	GND	B9	GND	C9	GND	D9	GND

Signals on Pins A1, A2, B1, B2, C1, C2, D1 and D2 are the shared sideband signals.

### 4.3 SAS/SATA Drive Support

The Intel® Tri-Mode RAID Adapters are designed to support SAS, SATA and NVMe drives; however, if desired, they can be used to connect only SAS and SATA drives. In this case, standard SAS cables and backplanes can be used (make sure to use only those backplanes which have been tested and listed as compatible hardware).

The Intel® Tri-Mode RAID Adapters support the *ANSI Serial Attached SCSI standard, version 3.0*. In addition, the adapters support the SATA III protocol defined by the *Serial ATA specification (SAS), version 3.0*. Supporting both the SAS interface and the SATA interface, the SAS adapter is a versatile adapter that provides the backbone of both server and high-end workstation environments.

Each port on the RAID Adapter supports SAS devices, SATA devices, or both, through these protocols:

- SAS Serial SCSI Protocol (SSP), which enables communication with other SAS devices
- SATA, which enables communication with other SATA devices
- Serial Management Protocol (SMP), which communicates topology management information directly with an attached SAS expander device, and
  - Serial Tunneling Protocol (STP), which enables communication with SATA devices through an attached expander.

SAS technology brings a wealth of options and flexibility with the use of SAS devices and SATA devices within the same storage infrastructure. However, SAS devices and SATA devices bring individual characteristics that make each one a more suitable choice depending on the requirements of the given operating environment and storage needs. The Intel® Tri-Mode Adapters provides the flexibility to combine these two (2) storage technologies on the same adapter and within the same enclosure.

---

**Note:** combining SAS drives and SATA drives within the same virtual drive is allowed on some adapters but Intel discourages this practice.

---

## 4.4 Intel® 12 Gb/s SAS 3.0 Expander Support

For system configurations that require more physical SAS/SATA drives than the adapter's number of ports, the Intel® Tri-Mode RAID Adapters can support the following Intel® RAID Expanders:



Intel Product Code	Product Description
<p><b>iPC – RES3FV288</b></p>  <p>Intel® SAS Expander RES3FV288</p>	<p><b>SAS 3.0 12 Gb/s expander</b></p> <ul style="list-style-type: none"> <li>• Featuring 6Gbps data aggregation for 12Gbps data transfer with 6Gb/s devices</li> <li>• Low Profile MD2 PCIe* add-in card form factor</li> <li>• 28 internal ports and 8 external ports</li> <li>• Power from PCIe x1</li> <li>• HD Mini-SAS 8643 Connectors</li> </ul> <p><b>Kit includes:</b> (1) SAS Expander card, (2) HD-HD 250mm Expander-to-RAID card cables, and PCI brackets for low profile and full height.</p>
<p><b>iPC – RES3TV360</b></p>  <p>Intel® SAS Expander RES3TV360</p>	<p><b>SAS 3.0 12 Gb/s expander</b></p> <ul style="list-style-type: none"> <li>• Featuring 6Gbps data aggregation for 12Gbps data transfer with 6Gb/s devices</li> <li>• Internal mount mid-plane form factor</li> <li>• 36 internal ports supporting point-to-point 12, 6, and 3 Gb/s data transfer rates</li> <li>• RA 4-pin power connector</li> <li>• HD Mini-SAS 8643 connectors</li> </ul> <p><b>Kit includes:</b> (1) SAS expander card; (1) 130mm power cable; (1 set) Expander-to-backplane cables: (4) HD-HD 165mm, (1) HD-HD 300mm, (1) HD-HD 250mm, (3) Rubber Pads, and mounting screws.</p>

Figure 10. Supported Intel® SAS expander options

### 4.4.1 SAS Expander Configuration for the Intel® RSP3TD160F RAID Adapter

The SAS ports of the Intel® RSP3TD160F RAID Adapter are driven by two (2) SAS cores and therefore, are divided into two (2) separate SAS domains: Domain 1 and Domain 2. One or two SAS connectors within a common domain can be cabled to a single SAS Expander Card when cabling the RAID Adapter to a SAS Expander.

**Note:** Mixing SAS ports from different domains to a single SAS expander card is not supported.

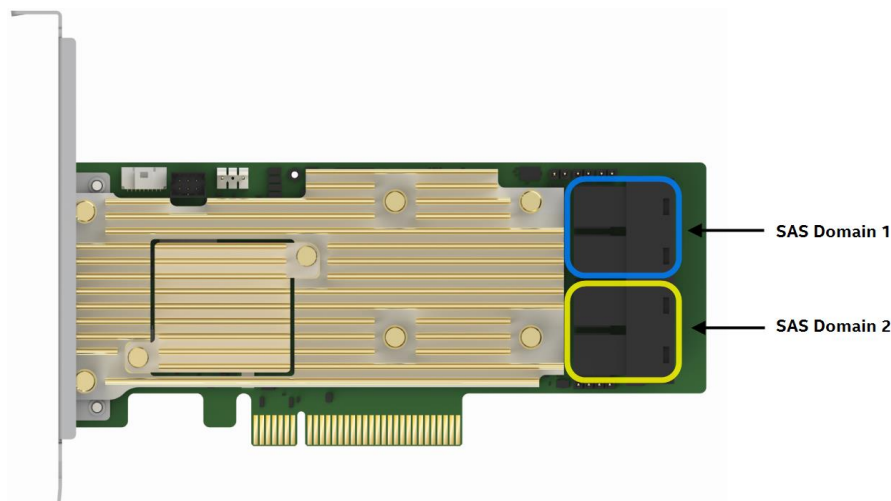

**Figure 11. RAID Adapter RMS3PTD160 SAS port domain identification**

Supported Intel SAS Expanders include several multiport mini-SAS HD (8643) connectors. Some are used as output connectors to a backplane while others are used as input connectors from the RAID Adapter. The following diagrams identify the connector types for each supported SAS expander card.

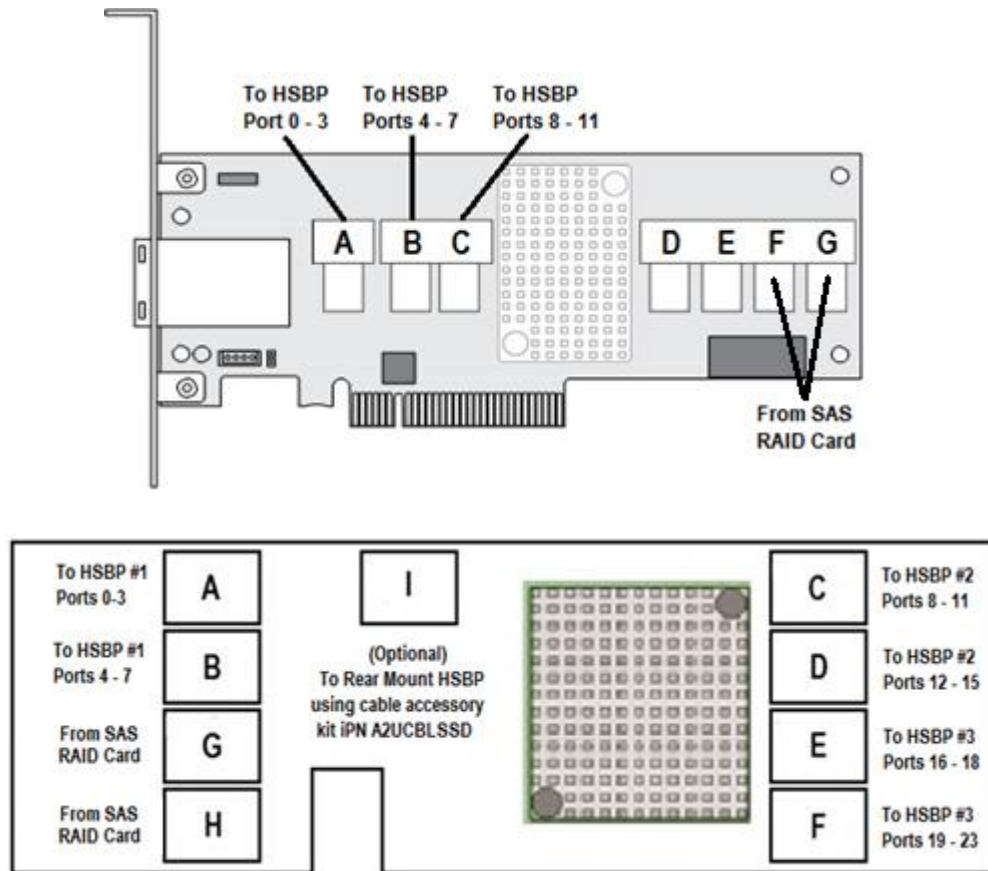

**Input Cable Configuration NOTES:**

The SAS Expander cards identified above can support one (1) or two (2) Input SAS port cables.

When routing two (2) input SAS port cables from the RAID Adapter, use cables from the same SAS domain, as illustrated on the previous page.

**Important notice:**

**Be careful not to connect a SAS expander to a RAID Adapter port configured for NVMe use.**

## 4.5 NVMe Drive Support

The Intel® Tri-Mode RAID adapters are designed to support SAS, SATA and NVMe drives; however, if desired, they can be used to connect only NVMe drives.

The support for NVMe drives is limited to the U.2 (SFF-8639) form factor, connected through a supported backplane using a specially designed Tri-Mode cable. This cable has one (1) dual SF- SFF-8643 (Mini-SAS High-Density) on one end and two (2) OCUlink connectors on the other end to connect to the backplane (the backplane too has both, SF- SFF-8643 and OCUlink connectors). The Intel Part Number for this cable is AXXCBL700HDCV and it connects up to two NVMe drives.

**Note 1:** Previous generation servers like the R2000WT family or the S2600CW family provide support for NVME drives using a special NVMe kit which includes a backplane. This backplane only has SFF-8643 (Mini-SAS HD) connectors and is NOT compatible with the Tri-Mode RAID Adapters.

**Note 2:** Using the cable AXXCBL700HDCV on a RAID adapter other than the Tri-Mode RAID adapters can damage your equipment. Only use the cables intended for those adapters.

The next figures show how to connect the AXXCBL700HDCV cable

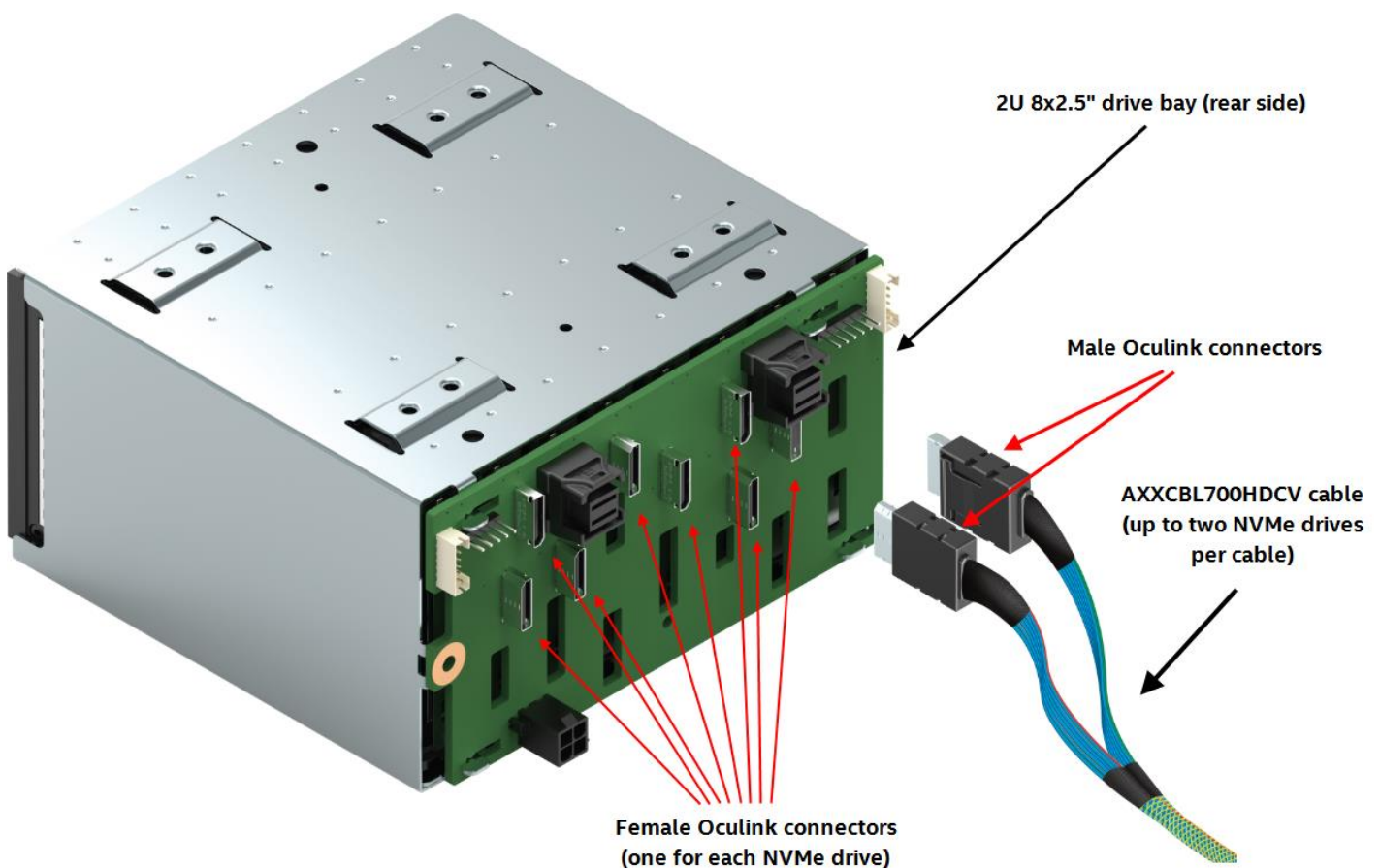

Figure 14. Connecting the AXXCBL700HDCV to the backplane

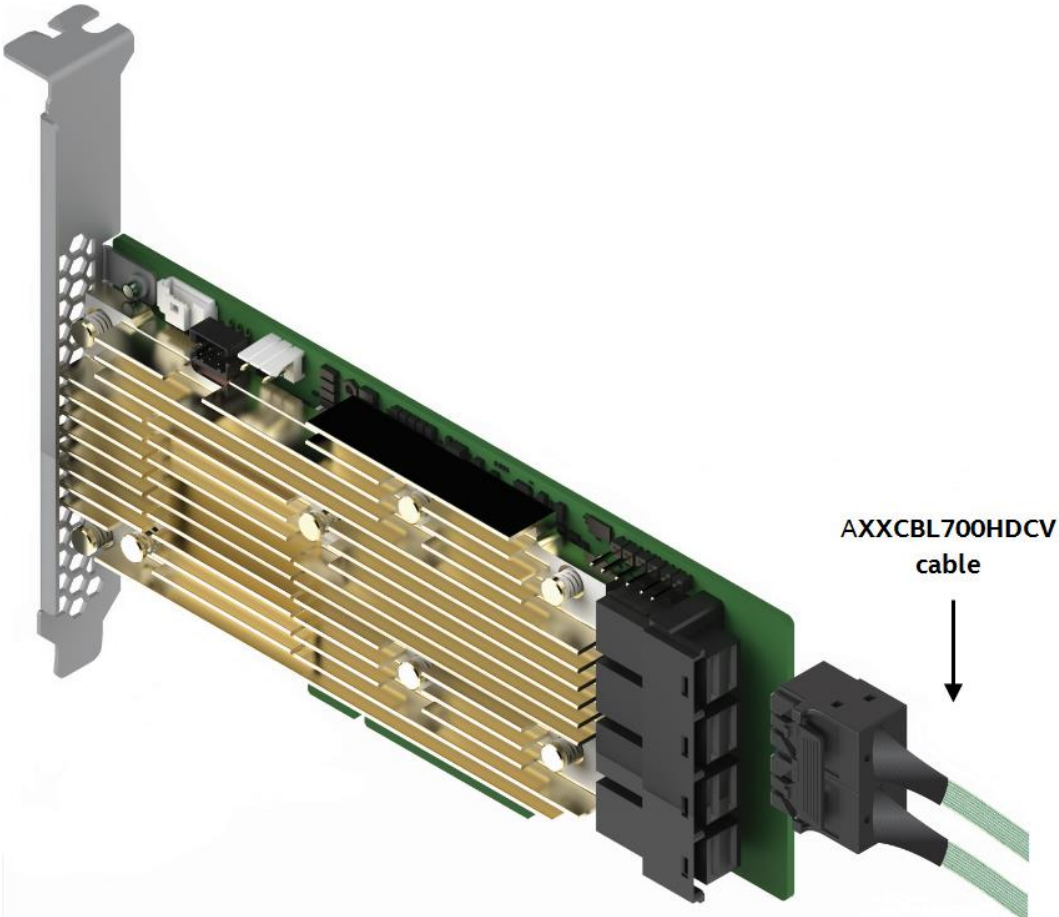

Figure 15. Connecting the AXXCBL700HDCV cable to the RAID adapter

## 5. Hardware Installation

### Warnings

**Heed safety instructions:** Before working with your server product, whether you are using this guide or any other resource as a reference, pay close attention to the safety instructions. You must adhere to the assembly instructions in this guide to ensure and maintain compliance with existing product certifications and approvals. Use only the described, regulated components specified in this guide. Use of other products/components will void the UL listing and other regulatory approvals of the product and will most likely result in noncompliance with product regulations in the region(s) in which the product is sold.

**System power on/off:** The power button DOES NOT turn off the system AC power. To remove power from the system, you must unplug all AC power cords from the server system before you open the chassis, add, or remove any components.

**Hazardous conditions, devices and cables:** Hazardous electrical conditions may be present on power, telephone, and communication cables. Turn off the server and disconnect the power cord, telecommunications systems, networks, and modems attached to the server before opening it. Otherwise, personal injury or equipment damage can result.

**Installing or removing jumpers:** A jumper is a small plastic encased conductor that slips over two jumper pins. Some jumpers have a small tab on top that you can grip with your fingertips or with a pair of fine needle nosed pliers. If your jumpers do not have such a tab, take care when using needle nosed pliers to remove or install a jumper; grip the narrow sides of the jumper with the pliers, never the wide sides. Gripping the wide sides can damage the contacts inside the jumper, causing intermittent problems with the function controlled by that jumper. Take care to grip with, but not squeeze, the pliers or other tool you use to remove a jumper, or you may bend or break the pins on the board.

#### Electrostatic Discharge (ESD)

Electrostatic discharge can cause damage to your computer or the components within it. ESD can occur without the user feeling a shock while working inside the system chassis or while improperly handling electronic devices like processors, memory or other storage devices, and add-in cards.



Intel recommends the following steps be taken when performing any procedures described within this document or while performing service to any computer system.

- Where available, all system integration and/or service should be performed at a properly equipped ESD workstation
- Wear ESD protective gear like a grounded antistatic wrist strap, sole grounders, and/or conductive shoes
- Wear an anti-static smock or gown to cover any clothing that may generate an electrostatic charge
- Remove all jewelry
- Disconnect all cables and cords attached to the server before performing any integration or service
- Touch any unpainted metal surface of the chassis before performing any integration or service
- Hold all circuit boards and other electronic components by their edges only
- After removing electronic devices from the system or from their protective packaging, place them component side up on to a grounded anti-static surface or conductive foam pad. **Do not** place electronic devices on to the outside of any protective packaging.



## 5.1 RAID Adapter Installation

### 5.1.1 Requirements

The following items are required to install an Intel® RAID Adapter:

- Intel® RAID Adapter
- Intel server board based server system with support for an Intel Integrated RAID Adapter
- Internal SAS/SATA data cables
- SAS drives or SATA drives

### 5.1.2 Packing List

- 1 – Intel RAID Adapter
- 2 – Low profile mounting bracket
- 3 – Attention Document
- 4 – Warranty Document

---

**Note:** Intel RAID Products do not include SAS / SATA data cables. Appropriate SAS / SATA data cables may be included with your server system or must be purchased separately.

---

### 5.1.3 Installation Instructions

1. Unpack the Intel® RAID Adapter.  
Unpack your RAID Adapter. Inspect it for damage. If it appears damaged, contact your Intel Customer and Technical Support representative.
2. Turn off the power to the computer, and disconnect the AC power cord.
3. Remove the computer cover. Refer to the system documentation for instructions.
4. Install the RAID Adapter.
  - a) Remove the riser card (the adapter can be installed on any riser card)
  - b) Remove the filler panel
  - c) Insert the adapter in the desired slot. Press down gently, but firmly to make sure that the card is seated correctly in the slot. Secure the bracket with the bracket screw.

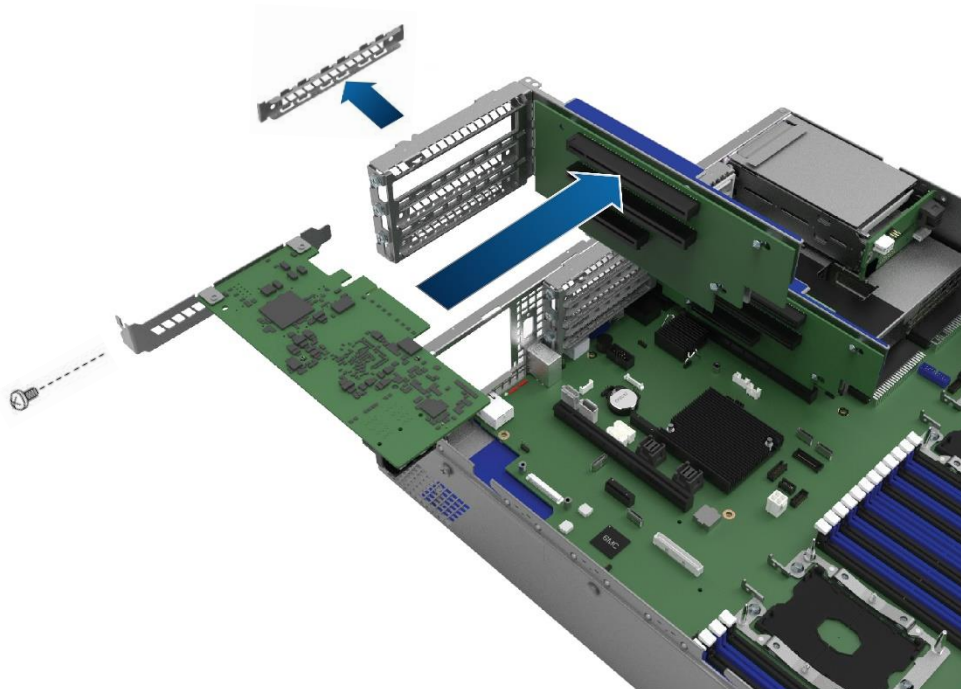

Figure 16 RAID Adapter Installation (insert adapter in slot)

d) Insert back the riser card, press down gently, but firmly.

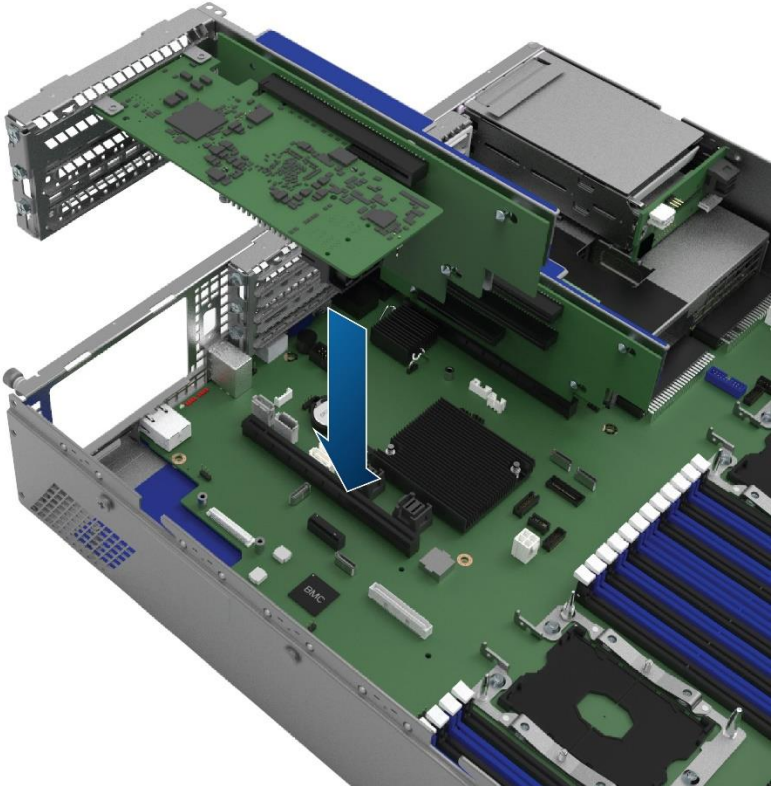

Figure 17 RAID Adapter Installation (insert riser card)

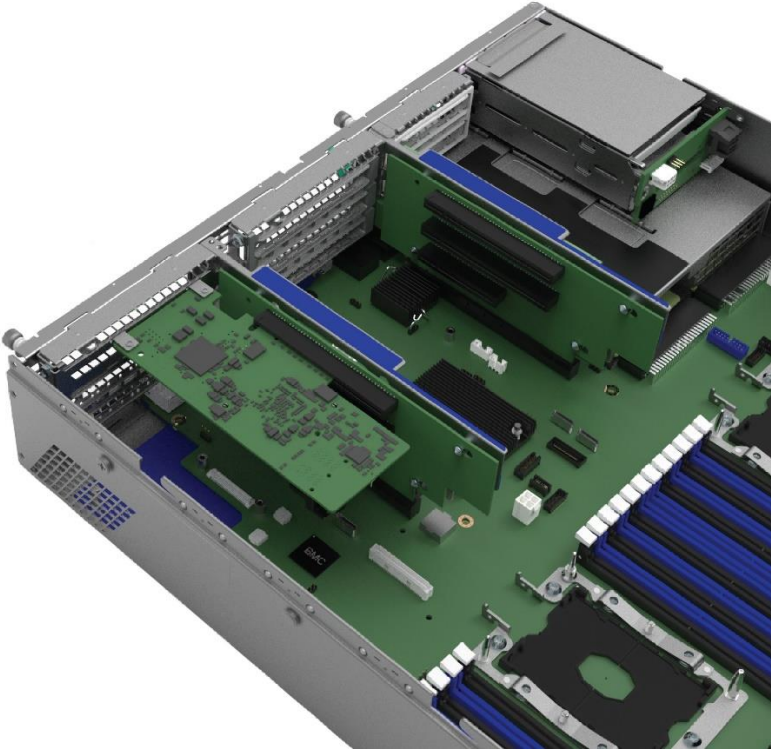

Figure 18 RAID Adapter Installation (adapter installed)

5. Install SAS and / or SATA drives in the host computer case. Refer to the documentation for the devices for any pre-installation configuration requirements.
6. Connect internal SAS / SATA data cables to appropriate Drives or Backplane
7. Carefully route SAS / SATA data cables back to the Intel RAID Adapter
8. Attach SAS / SATA data cables to the Intel RAID Adapter
9. Reinstall the computer cover, and reconnect the AC power cords to the system

The hardware installation is now complete and the Intel RAID Adapter is ready to be configured. For complete Intel RAID Adapter configuration information, refer to the **Intel® RAID Software User Guide for full featured and entry level RAID controllers** available to download from the Intel Support Site:

<http://support.intel.com>

## 6. Safety and Regulatory (Class A)

Intel RAID products typically have a variety of individual component level certifications; however final regulatory compliance is based on the combination of the RAID card being within an Intel Server System.

**Intended Application** – The RAID products are evaluated as Information Technology Equipment (ITE) as part of Intel's server chassis systems. These products are intended to be into Intel server systems that will be installed in offices, schools, computer rooms, and similar commercial type locations. The suitability of this product for other product categories and environments (such as: medical, industrial, telecommunications, NEBS, residential, alarm systems, test equipment, etc.), other than an ITE application, may require further evaluation. Product Safety and EMC Compliance noted below is based on the RAID product into an Intel server.

### 6.1 Product Safety Compliance

- UL60950 – CSA 60950(USA / Canada)
- EN60950 (Europe)
- IEC60950 (International)
- CB Certificate & Report, IEC60950 (report to include all country national deviations)
- CE - Low Voltage Directive 2006/95/EC (Europe)

### 6.2 Product EMC Compliance – Class A Compliance

- FCC /ICES-003 - Emissions (USA/Canada) Verification
- CISPR 22 – Emissions (International)
- EN55022 - Emissions (Europe)
- EN55024 - Immunity (Europe)
- CE – EMC Directive 2004/108 EC (Europe)
- VCCI Emissions (Japan)
- AS/NZS 3548 Emissions (Australia / New Zealand)
- BSMI CNS13438 Emissions (Taiwan)
- KC Certification (Korea)

### 6.3 Product Environmental Compliance

Intel has a system in place to restrict the use of banned substances in accordance with worldwide regulatory requirements. A Material Declaration Data Sheet is available for Intel products. For more reference on material restrictions and compliance you can view Intel's Environmental Product Content Specification at <http://supplier.intel.com/ehs/environmental.htm>.

- Europe - European Directive 2002/95/EC
  - Restriction of Hazardous Substances (RoHS)  
Threshold limits and banned substances are noted below.  
Quantity limit of 0.1% by mass (1000 PPM) for:  
Lead, Mercury, Hexavalent Chromium,  
Polybrominated Biphenyls Diphenyl Ethers (PBB/PBDE)  
Quantity limit of 0.01% by mass (100 PPM) for:  
Cadmium

- California Code of Regulations, Title 22, Division 4.5, Chapter 33:  
Best Management Practices for Perchlorate Materials
- China – Restriction of Hazardous Substances (China RoHS)
- WEEE Directive (Europe)
- Packaging Directive (Europe)
- REACH Directive (Europe)

## **7. Intel® RAID Maintenance Free Backup Unit AXRMFBU7**

---

### **7.1 Intel® RAID Maintenance Free Backup Unit AXRMFBU7**

Intel® RAID Adapters provide reliability, high performance, and fault-tolerant disk subsystem management. A complete fault-tolerant strategy requires protection of all data, including the unwritten cached data in the RAID card's RAM cache. If power is lost, the data in the RAM cache is lost. To avoid losing this data, a RAID Maintenance Free Backup Unit (RMFBU) can be added to the configuration.

During normal system operation, the RMFBU monitors the voltage level of the DRAM of the Intel® RAID Adapter or Intel® RAID Adapter. If the voltage drops below a predefined level due to an AC power failure or brief power outage, the RMFBU protects the integrity of the cached data by providing sufficient back-up power to offload the data from the RAID RAM to the NAND flash. When the voltage level returns to an acceptable level, the RAID RAM is recovered from flash, and all pending writes to storage devices are completed without losing any data. The cache memory available on Intel® RAID Adapters and Intel® RAID Adapters can improve the overall system performance. Writing data to the adapter's cache memory is much faster than writing data to a storage device. Write operations appear to complete very quickly at the software application level. The Intel® RAID Adapter writes the cached data to the storage device when system activity is low or when the cache is getting full. The risk of using write-back cache is that the cached data can be lost if the AC power fails before it is written to the storage device. This risk factor is eliminated when the Intel® RAID Adapter has an RMFBU installed. In addition, the RMFBU provides an alternative to using an Uninterruptible Power Supply (UPS) or can act as a second level of fault tolerance when used with a UPS. Furthermore, it eliminates the need for lithium ion (Li-ion) batteries traditionally used to protect DRAM cache memory on PCI RAID adapters. Therefore, this is a greener and lower total cost cache protection solution.

The RMFBU has built-in functionality to charge the capacitor Adapter automatically and to communicate status information such as voltage, temperature, and current to the host server system.

The AXRMFBU7 RMFBU is a kit consisting of a FBU345 super capacitor bank, a plastic bracket to attach the super capacitor bank to the chassis, and two (2) extender cables, one 605 mm long and the other 930 mm long. The FBU345 consists of a bank of Electric Double-Layer Capacitors (EDLC) or super capacitors capable of storing a high amount of electric energy while active. In the event of a power failure, the FBU345 provides the power needed for the data offload. It also has an over-temperature detection circuitry and a discharge circuitry that discharges the capacitors while disconnected from the RAID adapter or when the system on which it is installed is turned off.

## 7.2 FBU345 Specifications and Layout

The Table 8. FBU345 specifications shows the specifications for the FBU 345 Supercap. The Figure 19. FBU345 layouts same device followed by its dimensions and pin description.

Item	Value
Super Capacitor Adapter Operating Temperature	0°C to 55°C
Super Capacitor Adapter Storage Temperature	0°C to 70°C
Rated Voltage	13.5 VDC
Surge Voltage	14.25 VDC
Super Capacitor Adapter Capacity	7.6 F
Capacity Tolerance	65 mm x 52 mm
RMFBU5 Cache Off-load Adapter Mechanical	-0%, +30%
Rated Energy	0.04 Wh
Super Capacitor Adapter Charge Time	Approximately 2 minutes
Super Capacitor Adapter Shelf Life	3 years
Super Capacitor Adapter Operational Life	Intel provides a three-year warranty on the Intel® RMFBU AXRMFBU7.
Maximum Equivalent Series Resistance (ESR)	190 mOhm
Weight	46 g

**Table 8. FBU345 specifications**

## 7.3 Heat considerations

The FBU345 does not generate any significant heat by itself but the heat from other adjacent sources may affect it. This device is very sensitive to the high operating temperature, and excessive heat may shorten its life. The over temperature detection circuitry sends an event to the RAID adapter when the operating temperature is over 55 degrees Celsius, which gets registered in the adapter's log file.

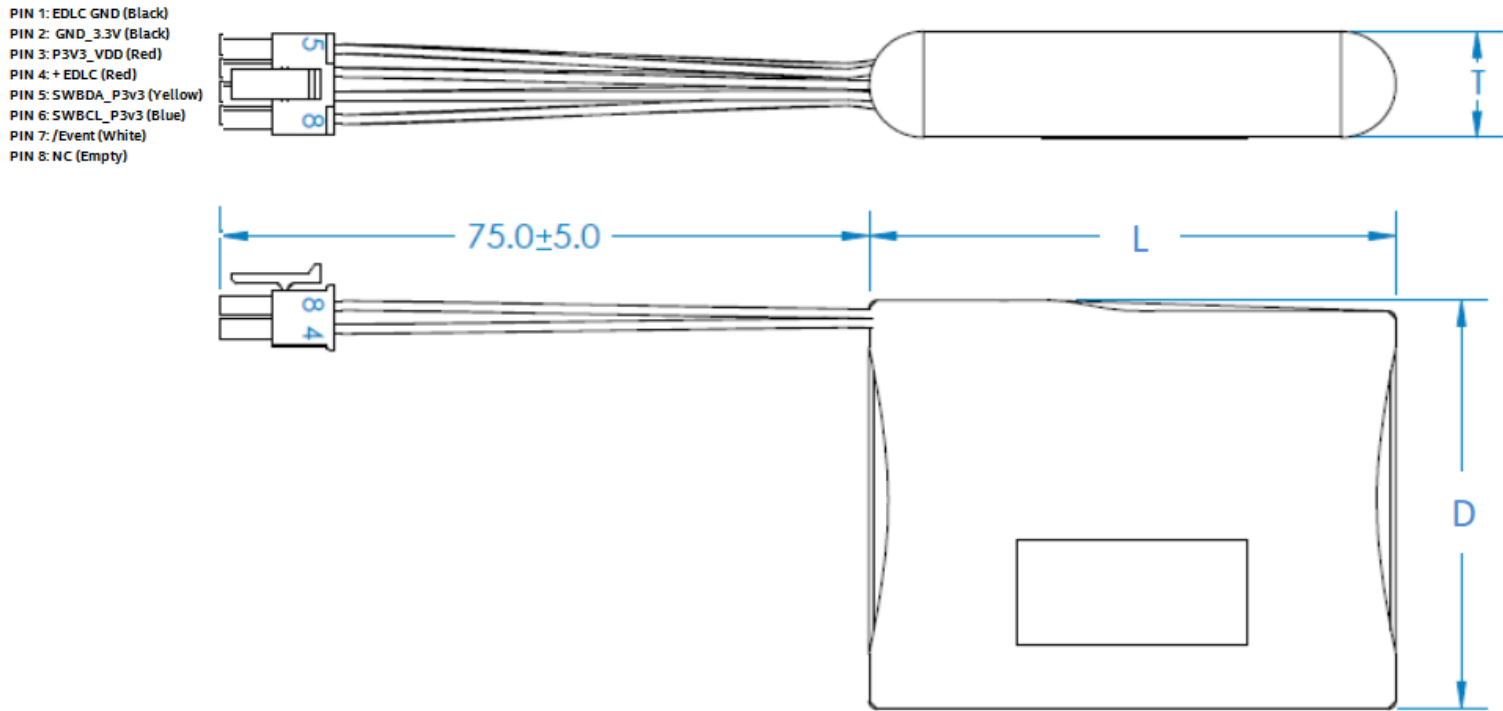

**Figure 19. FBU345 layout**

**FBU 345 Dimensions**

Width (D)	51.0 +/- 1.0 mm
Length (L)	64.0 +/- 1.0 mm
Height T	13.1 +/- 0.4 mm

**Pin Description**

Pin #	Signal	Color
1	EDLC GND	Black
2	GND_3.3V	Black
3	P3V3_VDD	Red
4	+EDLC	Red
5	SWBDA_P3V3	Yellow
6	SWBCL_P3V3	Blue
7	/Event	White
8	NC	Empty



### 7.3.1 Extender Cable

The extender cable has an 8-pin Molex 43020-0601 connector on one end and a 9-pin Molex 501330-0900 connector on the other end. Two (2) versions of the cable are included in the kit, one 605 mm long and the other 930 mm long. The routing of the cable is shown in Figure 20. Extender cable pinout

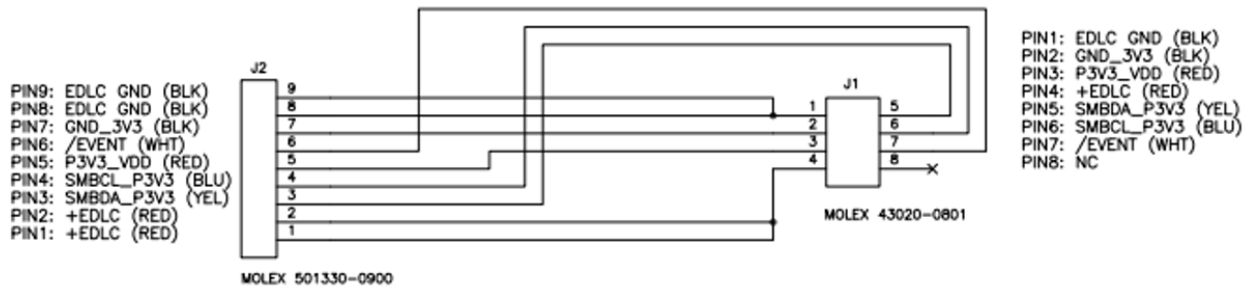

Figure 20. Extender cable pinout

## 7.4 Intel® RAID Maintenance Free Backup Unit Installation

The mounting hardware included with Intel® Accessory Kit AXSRMFBU7 is designed to be compatible for installation in to a supported Intel pedestal and rack mount server system. An alternate attachment method may be needed when installing this accessory into a non-Intel chassis. Intel recommends using industrial-grade Velcro\* or other industrial adhesive material as an acceptable option. Refer to the server chassis documentation or discuss an appropriate attachment method with the server chassis manufacturer to ensure the attachment mechanism complies with the chassis requirements.

1. Place the Super Capacitor Adapter and the plastic holder front-side-up on a flat, clean, static-free surface.
2. Press the Super Capacitor Adapter into the plastic holder until the Adapter clicks firmly into place, as shown in the following figure (note that the actual shape of the product may vary).

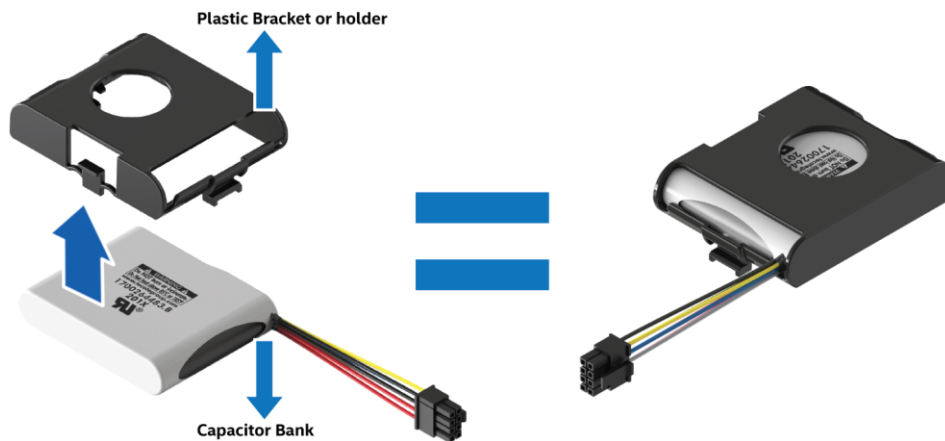

Figure 21 - AXSRMFBU7 Mounting Assembly

3. Identify the mounting location for the RMFBU Assembly
  - a) In a compatible Intel Server system, align the tabs on the holder with the holes on the mounting plate and slide the holder until it clicks and locks into place.

b) In a non-Intel chassis, apply adhesive material to the RMFBU assembly and affix to desired mounting location within the chassis.

### 2U System – Air Duct RMFBU Mounting Plate

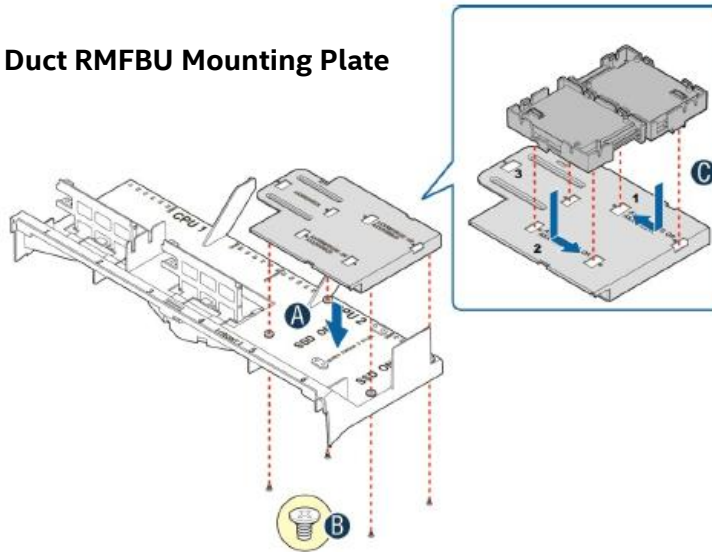

Figure 22 - RMFBU Assembly Installation

4. Carefully route the extender cable to the Intel RAID Adapter and attach the cable to the matching connector. Use the appropriate cable (605 mm or 930 mm long) that best fits.

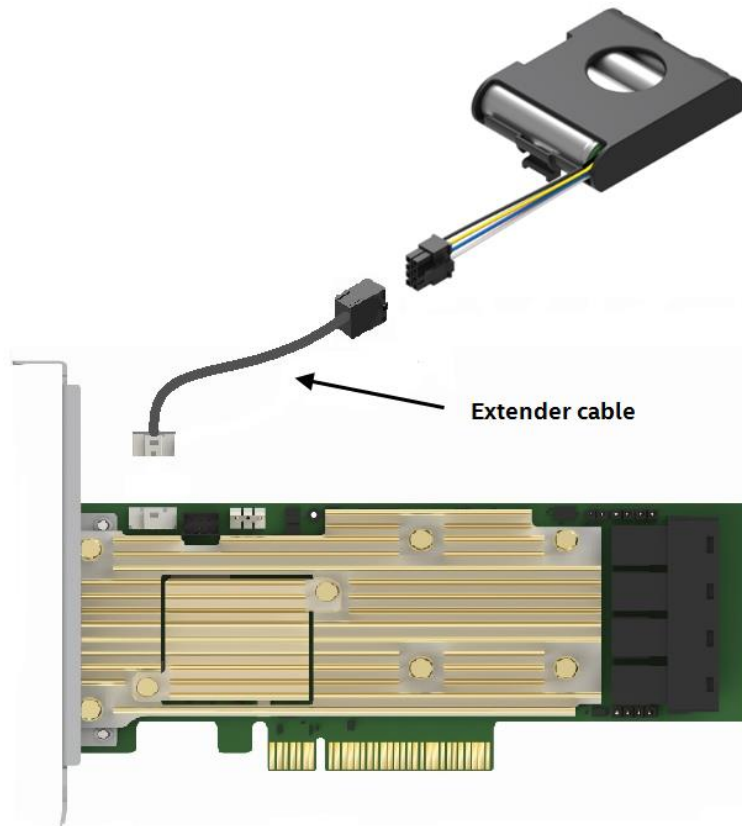

Figure 23 - Connecting the RMFBU7 to the RAID adapter

## 7.5 Monitoring the Intel® RAID Maintenance Free Backup Unit

Three different utilities can be used to monitor the RMFBU: StorCli, RAID Web Console 3 and HII. This section only describes how to use HII for this purpose. For details on how to monitor using the other utilities, consult the Intel® RAID Utilities User Guide.

### 7.5.1 Monitoring the RMFBU with the Human Interface Infrastructure.

The Human Interface Infrastructure (HII) can be used to configure disk arrays and logical drives. It is independent of the operating system and can be accessed at server start-up through the Setup BIOS. The HII can only be accessed when the system is configured for UEFI boot mode. The HII can also be used to monitor the MFBU.

**Note:** Refer to the *Intel® RAID Software User Guide for full featured and entry level RAID controllers* for more information on the Human Interface Infrastructure.

To view the RMFBU information, do the following:

1. At boot, press the <F2> key when prompted and enter the Setup BIOS.
2. Navigate to **Main, Advanced, PCI Configuration**, and then **UEFI Option ROM Control**.
3. Look for the RAID card under the **Storage Controller** list.
4. Press **Enter** to get into the Main Menu for the **HII Configuration Utility**.

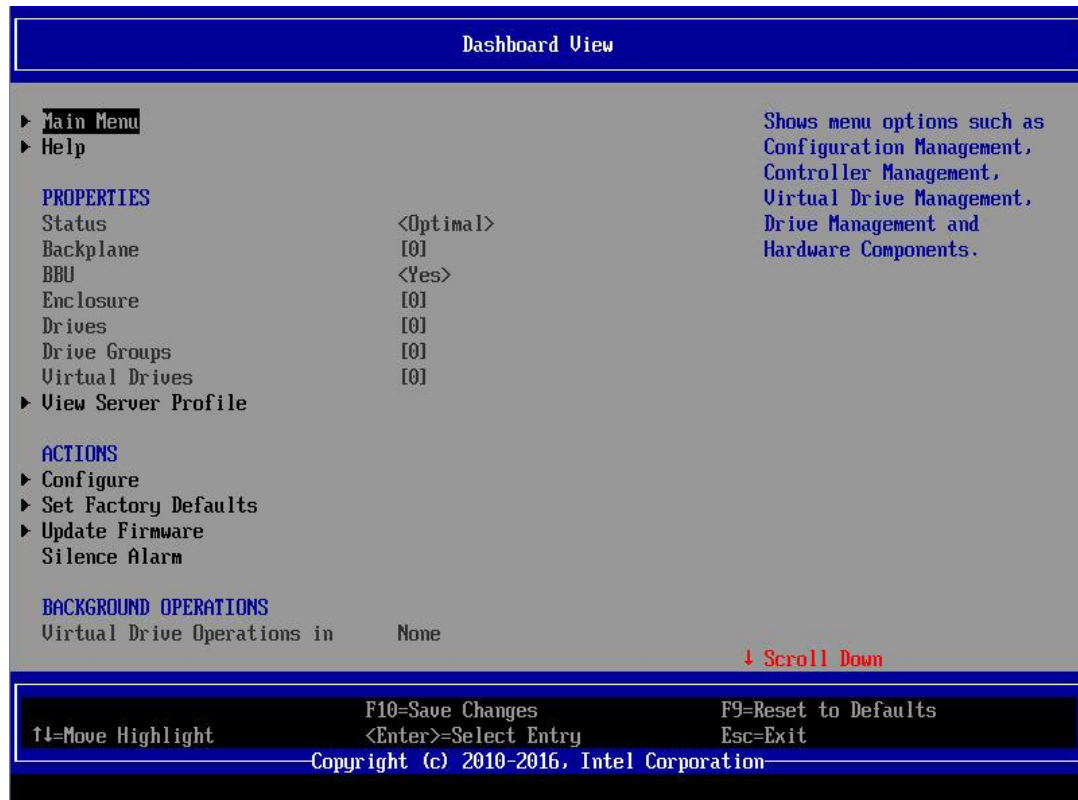

Figure 24. HII Dashboard view screen

5. Enter the **Main Menu** and select **Hardware Components** to go to the **Hardware Component Screen**.



Figure 25. HII Hardware Components screen

- The **Hardware Component Screen** shows the **Battery Status**. Select the **Battery Management** option.

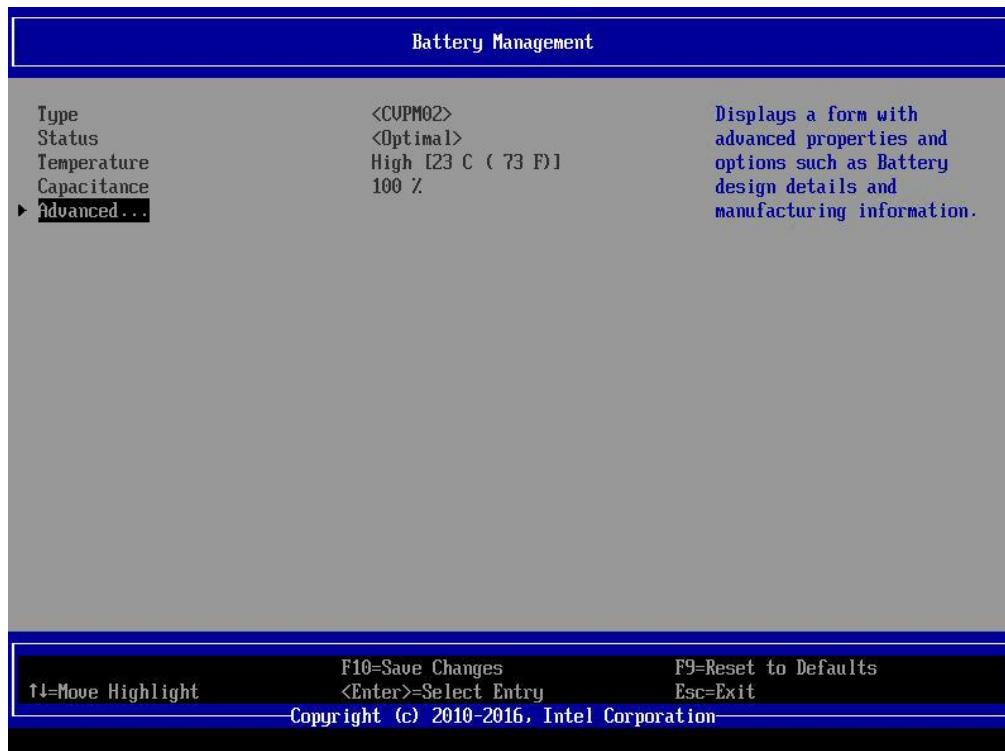

Figure 26. HII Battery Management screen

- The **Battery Management** screen contains the following information:

Battery Type	A string that identifies the RMFBU type.
--------------	--

Battery Status	The current status of the RMFBU, normally it should be optimal.
Temperature	The current temperature of the battery pack or supercap
Capacitance	With time, the capacitance decreases, this field shows the current capacitance of the battery pack or supercap.

8. Select the **Advanced** field at the bottom of the of the **Battery Management Screen**.

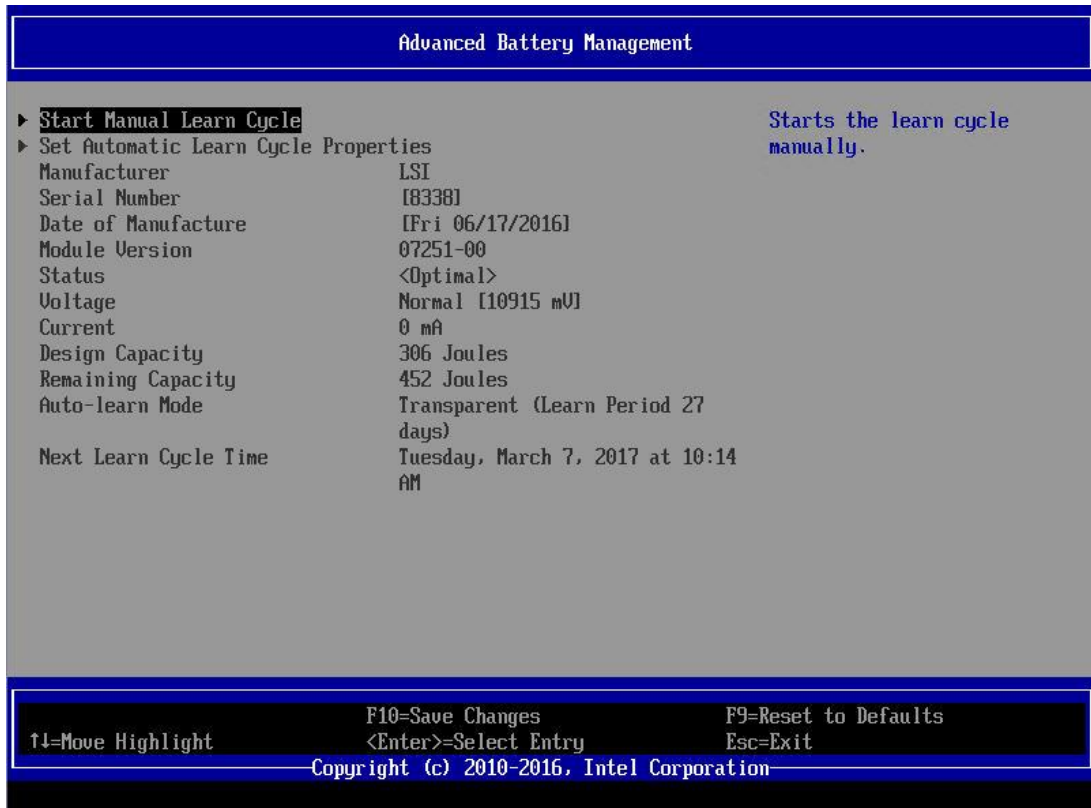

9. The **Battery Management Screen** contains the following information:

Manufacturer	The manufacturer of the RMFBU unit.
Serial Number	The serial number of the RMFBU unit.
Date of Manufacture	The date of manufacture of the RMFBU unit.
Adapter Version	The identifier of the version of the firmware that controls the RMFBU.
Status	The current status of the RMFBU, normally it should be optimal.
Voltage	The current voltage of the RMFBU unit.
Current	The amount of current being delivered by the RMFBU.
Design Capacity	The original capacitance that was intended for the Supercap.
Remaining Capacity	The capacitance left in the Supercap.
Auto-learn Mode	The learning mode currently set for the RMFBU.
Next Learn Cycle Time	The time and date for the next learn cycle.

## Appendix A. Glossary

Term	Description
BIOS	<p>Acronym for Basic Input/Output System. Software that provides basic read/write capability. Usually kept as firmware (ROM-based).</p> <p>The system BIOS on the motherboard of a computer boots and controls the system. The BIOS on your host adapter acts as an extension of the system BIOS.</p>
configuration	<p>Refers to the way a computer is set up, the combined hardware components (computer, monitor, keyboard, and peripheral devices) that make up a computer system, or the software settings that allow the hardware components to communicate with each other.</p>
device driver	<p>A program that permits a microprocessor (through the operating system) to direct the operation of a peripheral device.</p>
domain validation	<p>A software procedure in which a host queries a device to determine its ability to communicate at the negotiated data rate.</p>
DRAM cache memory	<p>Dynamic random access memory (DRAM) is a type of memory typically used for data or program code that a computer processor needs to function. DRAM is a common type of random access memory (RAM) used in personal computers (PCs), workstations, and servers.</p>
drive group	<p>A group of physical drives that combines the storage space on the drives into a single segment of storage space. A hot spare drive does not actively participate in a drive group.</p>
EEPROM	<p>Acronym for Electronically Erasable Programmable Read-Only Memory. It is a memory chip that typically stores configuration information, as it provides stable storage for long periods without electricity and can be reprogrammed. See NVRAM.</p>
EDLC	<p>Electric Double-Layer Capacitors</p>
external SAS device	<p>A SAS device installed outside the computer cabinet. These devices are connected using specific types of shielded cables.</p>
Fusion-MPT architecture	<p>Acronym for Fusion-Message Passing Technology architecture. Fusion-MPT consists of several main elements: Fusion-MPT firmware, the Fiber Channel and SCSI hardware, and the operating system-level drivers that support these architectures. Fusion-MPT architecture offers a single binary, operating system driver that supports both Fiber Channel and SCSI devices.</p>
host	<p>The computer system in which a RAID controller is installed. It uses the RAID controller to transfer information to and from devices attached to the SCSI bus.</p>
host adapter board	<p>A circuit board or circuit that provides a device connection to the computer system.</p>
hot spare	<p>An idle, powered on, standby drive that is ready for immediate use in case of drive failure. A hot spare does not contain any user data. A hot spare can be dedicated to a single redundant array or it can be part of the global hot-spare pool for all arrays managed by the controller.</p> <p>When a drive fails, the controller firmware automatically replaces and rebuilds the data from the failed drive to the hot spare. Data can be rebuilt only from virtual drives with redundancy (RAID levels 1, 5, 6, 10, 50, and 60; not RAID level 0), and the hot spare must have sufficient capacity.</p>
internal SAS device	<p>A SAS device installed inside the computer cabinet. These devices are connected by using a shielded cable.</p>
main memory	<p>The part of computer memory that is directly accessible by the CPU (usually synonymous with RAM).</p>

Term	Description
NVRAM	Acronym for nonvolatile random access memory. An EEPROM (electronically erasable read-only memory) chip that stores configuration information. See EEPROM.
PCI	Acronym for peripheral component interconnect. A high-performance, local bus specification that allows the connection of devices directly to computer memory. The PCI Local Bus allows transparent upgrades from 32-bit data path at 33 MHz to 64-bit data path at 33 MHz, and from 32-bit data path at 66 MHz to 64-bit data path at 66 MHz.
PCI Express	Acronym for peripheral component interconnect Express. A high-performance, local bus specification that allows the connection of devices directly to computer memory. PCI Express is a two-way, serial connection that transfers data on two pairs of point-to-point data lines. PCI Express goes beyond the PCI specification in that it is intended as a unifying I/O architecture for various systems: desktops, workstations, mobile, server, communications, and embedded devices.
peripheral devices	A piece of hardware (such as a video monitor, drive, printer, or CD-ROM) used with a computer and under the control of the computer. SCSI peripherals are controlled through an Intel® RAID Controller (host adapter).
PHY	The interface required to transmit and receive data packets transferred across the serial bus. Each PHY can form one side of the physical link in a connection with a PHY on a different SAS device. The physical link contains four wires that form two differential signal pairs. One differential pair transmits signals, while the other differential pair receives signals. Both differential pairs operate simultaneously and allow concurrent data transmission in both, thereceive and the transmit directions.
RAID	Acronym for Redundant Array of Independent Disks (originally Redundant Array of Inexpensive Disks). An array (group) of multiple independent drives managed together to yield higher reliability, performance, or both exceeding that of a single drive. The RAID array appears to the controller as a single storage unit. I/O is expedited because several drives can be accessed simultaneously. Redundant RAID levels (RAID levels 1, 5, 6, 10, 50, and 60) provide data protection.
RAID levels	A set of techniques applied to drive groups to deliver higher data availability, performance characteristics, or both to host environments. Each virtual drive must have a RAID level assigned to it.
SAS	Acronym for Serial Attached SCSI. A serial, point-to-point, enterprise-level device interface that leverages the proven SCSI protocol set. The SAS interface provides improved performance, simplified cabling, smaller connections, lower pin count, and lower power requirements when compared to parallel SCSI. SAS controllers leverage a common electrical and physical connection interface that is compatible with Serial ATA. The SAS controllers support the ANSI <i>Serial Attached SCSI Standard, Version 2.0</i> . In addition, the controller supports the Serial ATA III (SATA III) protocol defined by the <i>Serial ATA Specification, Version 3.0</i> . Supporting both the SAS interface and the SATA III interface, the SAS controller is a versatile controller that provides the backbone of both server and high-end workstation environments. Each port on the SAS RAID controller supports SAS devices, SATA devices, or both.
SAS device	Any device that conforms to the SAS standard and is attached to the SAS bus by a SAS cable. This includes SAS RAID controllers (host adapters) and SAS peripherals.
SATA	Acronym for Serial Advanced Technology Attachment. A physical storage interface standard, SATA is a serial link that provides point-to-point connections between devices. The thinner serial cables allow for better airflow within the system and permit smaller chassis designs.
SSP	Acronym for Serial SCSI Protocol. SSP enables communication with other SAS devices. Each PHY on the SAS controller can function as an SSP initiator.
stripe	The portion of a stripe that resides on a single drive.

<b>Term</b>	<b>Description</b>
stripe size	<p>The total drive space consumed by a stripe not including a parity drive. For example, if a stripe contains 64 KB of drive space and has 16 KB of data residing on each drive, the stripe size is 64 KB and the strip size is 16 KB.</p> <p>A larger stripe size produces improved read performance, especially if most of the reads are sequential. For mostly random reads, select a smaller stripe size.</p>
striping	<p>Drive striping writes data across two or more drives. Each stripe spans two or more drives but consumes only a portion of each drive. Each drive, therefore, may have several stripes. The amount of space consumed by a stripe is the same on each drive that is included in the stripe. The portion of a stripe that resides on a single drive is a strip, also known as a stripe element. Striping by itself does not provide data redundancy; striping in combination with parity provides data redundancy.</p>
strip size	<p>The drive space consumed by a strip. For example, if a stripe contains 64 KB of drive space and has 16 KB of data residing on each drive, the stripe size is 64 KB and the strip size is 16 KB. The stripe depth is four (four drives in the stripe).</p>
UPS	<p>Uninterruptible Power Supply. An electrical device that provides power off of a battery when the input power source (AC) fails.</p>



# Mouser Electronics

Authorized Distributor

Click to View Pricing, Inventory, Delivery & Lifecycle Information:

[Intel:](#)

[RSP3DD080F](#) [RSP3MD088F](#) [RSP3TD160F](#) [RSP3WD080E](#)