

Typical Applications

The HMC848LC5 is ideal for:

- SONET OC-768
- RF ATE Applications
- Broadband Test & Measurements
- Serial Data Transmission up to 45 Gbps
- High Speed ADC Interfacing

Features

- Supports Data Rates up to 45 Gbps
- Half Rate Clock Input
- Quarter Rate Reference Clock Output
- Fast Rise and Fall Times: 25 / 21 ps
- Programmable Differential Output Voltage Swing: 300 - 1000 mVp-p
- Single Supply: +3.3V
- 32 Lead Ceramic 5x5 mm SMT Package: 25 mm²

Functional Diagram

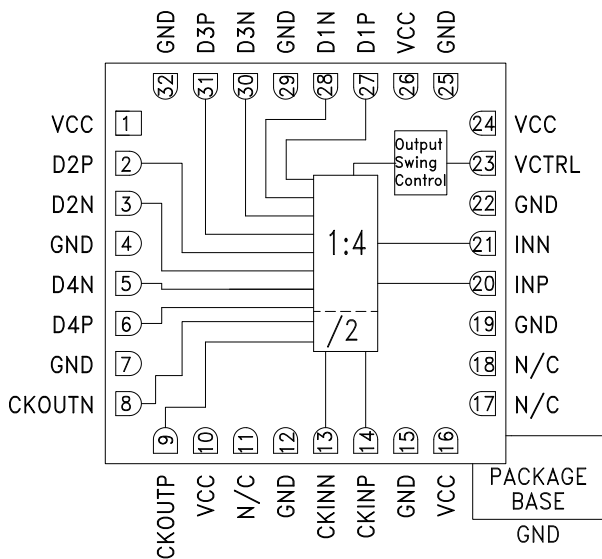

General Description

The HMC848LC5 is a 1:4 demultiplexer designed for data deserialization up to 45 Gbps. The device uses both rising and falling edges of the half-rate clock to sample the input data in sequence, D0-D3 and latches the data onto the differential outputs. A quarter-rate clock output generated on-chip can be used to clock the data into other devices.

All clock and data inputs / outputs of the HMC848LC5 are CML and terminated on-chip with 50 Ohms to the VCC, and may be DC or AC coupled. The inputs and outputs of the HMC848LC5 may be operated either differentially or single-ended. The HMC848LC5 also features an output level control pin, VCTRL, which allows for loss compensation or signal level optimization. The HMC848LC5 operates from a single +3.3V supply and is available in ROHS compliant 5x5 mm SMT package.

Electrical Specifications, $T_A = +25^\circ\text{C}$, $V_{CC} = 3.3\text{V}$

Parameter	Conditions	Min.	Typ.	Max	Units
Power Supply Voltage	± 5% Tolerance	3.13	3.3	3.47	V
Power Supply Current	Vctrl = 2.5V	480	540	600	mA
Output Amplitude Control Voltage Range (Vctrl)		1.7	2.5	3	V
Maximum Data Rate		45			Gbps
Maximum Clock Rate	Half Rate Clock	22.5			GHz
Input Amplitude (Data)	Single-Ended, peak-to-peak ^[1]	150		800	mVp-p
	Differential, peak-to-peak	150		1000	mVp-p
Input Amplitude (Clock)	Single-Ended, peak-to-peak ^[1]	100		700	mVp-p
	Differential, peak-to-peak	100		1000	mVp-p

[1] The un-used port is biased @ 3.3V



45 Gbps, 1:4 DEMUX WITH PROGRAMMABLE OUTPUT VOLTAGE

Electrical Specifications, (continued)

Parameter	Conditions	Min.	Typ.	Max	Units
Input High Voltage (Data & Clock)	Vctrl = 2.5V	2.8		3.8	V
Input Low Voltage (Data & Clock)	Vctrl = 2.5V	2.3		3.3	V
Data Output Voltage Swing Range	Differential, peak-to-peak @ 40 Gbps	300		1000	mVp-p
Clock Output Voltage Swing	Differential, peak-to-peak @ 10 GHz	600	700	800	mVp-p
Output High Voltage	Vctrl = 2.5V		2.95		V
Output Low Voltage	Vctrl = 2.5V		2.6		V
Input Return Loss	Data input up to 11.25 GHz		10		dB
	Clock input up to 22.5 GHz		9		dB
Output Return Loss	Data output up to 22.5 GHz		8		dB
	Clock output up to 11.25 GHz		8		dB
Deterministic Jitter, Jd [2]			4		ps p-p
Additive Random Jitter, Jr [3]			0.35		ps rms
Rise Time, tr [2]	20% - 80%		25		ps
Fall Time, tf [2]	20% - 80%		21		ps
Propagation Delay Clock to Data, Tdpd	Input clock to output data		380		ps
Propagation Delay Clock to Output Clock, Tcpd	Input clock to output clock		80		ps
Set Up Time, ts	Both at rising and falling edges		20		ps
Hold Time, th	Both at rising and falling edges		2		ps

[2] CKINP: 20 GHz clock signal, 250 mVp-p single-ended, INP: 40 Gbps PRBS 2²³-1 pattern, 250 mVp-p single-ended

[3] Random jitter is measured with 40 Gbps 10101... pattern

DC Current vs. Supply Voltage [1] [2]

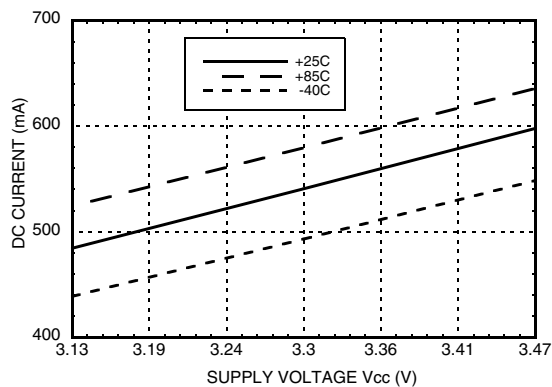

Differential Output Swing vs. Supply Voltage [1] [2]

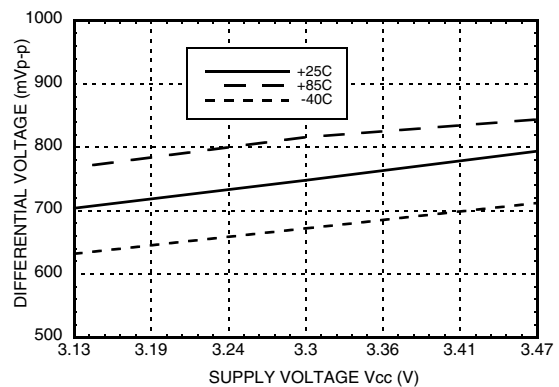

[1] Vctrl = 2.5V

[2] Data Rate = 40 Gbps

45 Gbps, 1:4 DEMUX WITH PROGRAMMABLE OUTPUT VOLTAGE

MUX & DEMUX - SMT

DC Current vs. Vctrl [1]

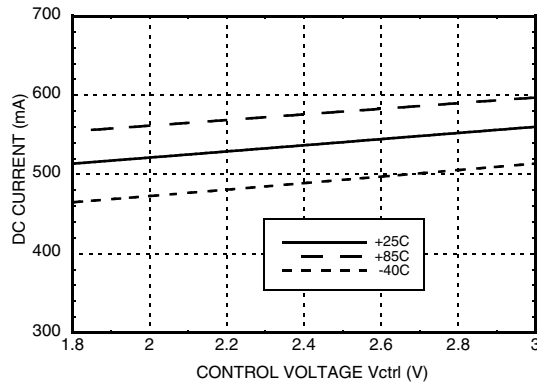

Differential Output Swing vs. Vctrl [1]

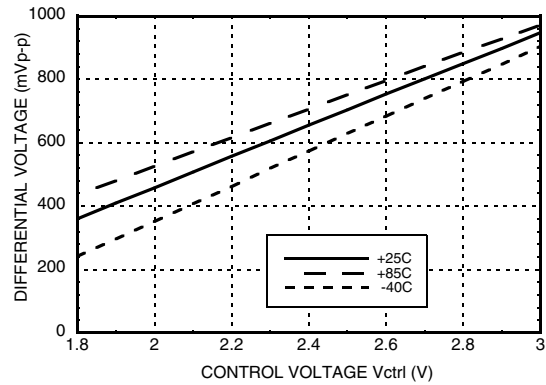

Rise Time vs. Supply Voltage [1][2][3][4]

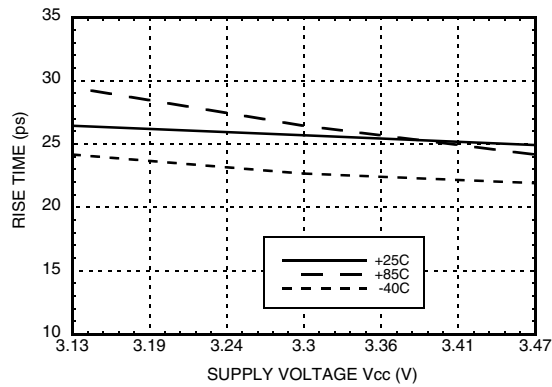

Fall Time vs. Supply Voltage [1][2][3][4]

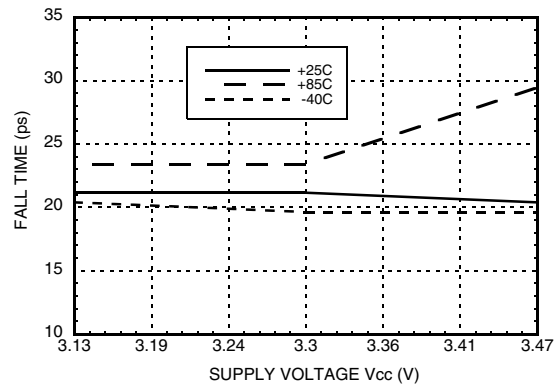

Rise Time vs. Vctrl [1][3][4]

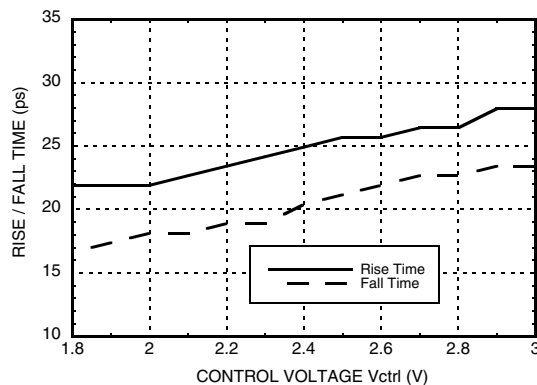

Peak-to-Peak Jitter vs. Supply Voltage [1][2][3][5]

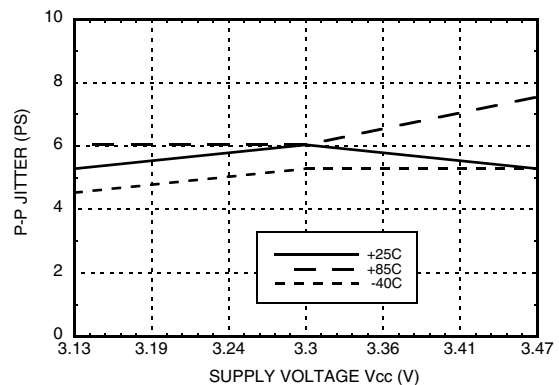

[1] Data Rate = 40 Gbps [2] Vctrl = 2.5V [3] Data was taken at single-ended output [4] 20% - 80%
 [5] Source jitter was not deembedded

45 Gbps, 1:4 DEMUX WITH PROGRAMMABLE OUTPUT VOLTAGE

Data Input Return Loss vs. Frequency [1][2]

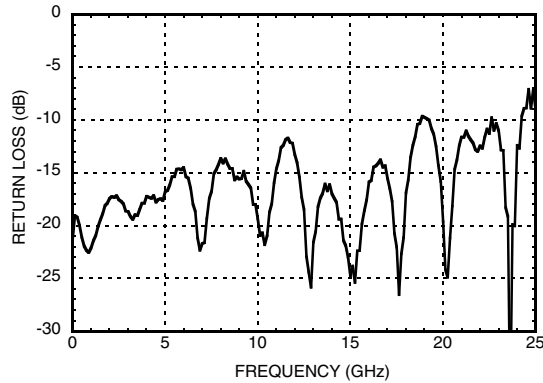

Data Output Return Loss vs. Frequency [1][2]

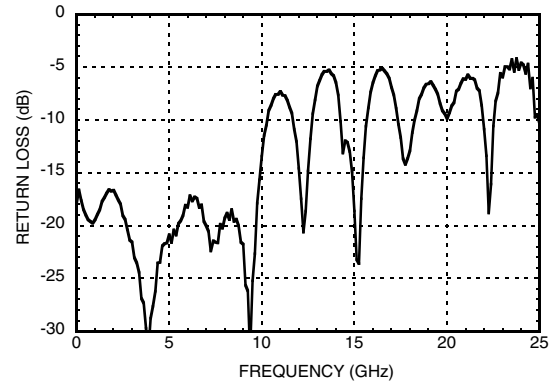

Clock Input Return Loss vs. Frequency [1][2]

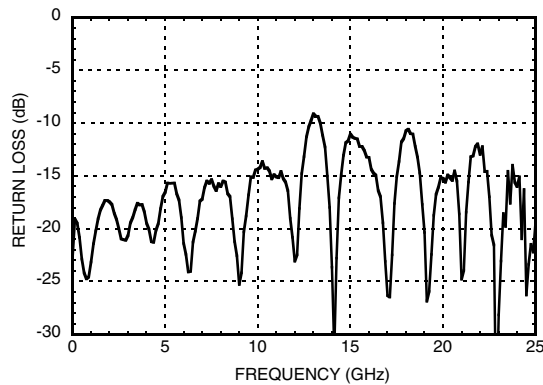

Clock Output Return Loss vs. Frequency [1][2]

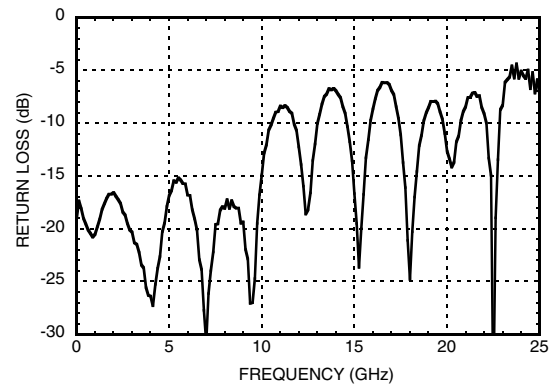

10 Gbps Single-Ended Output Eye Diagram

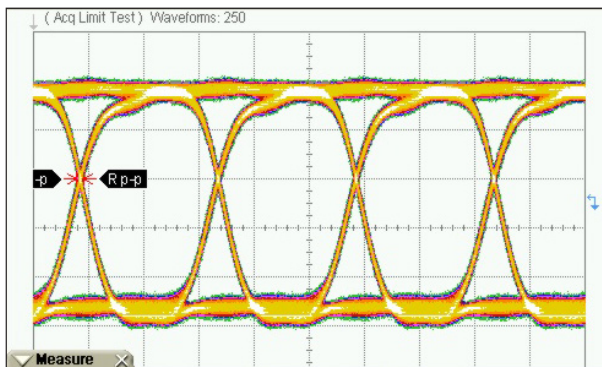

Measurements				
	Current	Minimum	Maximum	Total Meas.
Eye Amp	356 mV	356 mV	356 mV	84
Rise Time	25.8 ps	25.8 ps	26.7 ps	84
Fall Time	21.3 ps	21.3 ps	21.3 ps	84
p-p jitter	5.33 ps	4.44ps	5.33 ps	84

Time Scale: 40 ps/div
Amplitude Scale: 79.7 mV/div

Test Conditions:

VCC = +3.3V, VCTRL = 2.5V

INP: 40 Gbps NRZ PRBS 2²³-1 pattern, 250 mVp-p single-ended

CKINP: 20 GHz Clock Signal, 250 mVp-p single-ended

[1] Vctrl = 2.5V

[2] Device measured on evaluation board with single ended time domain gating

Timing Diagram

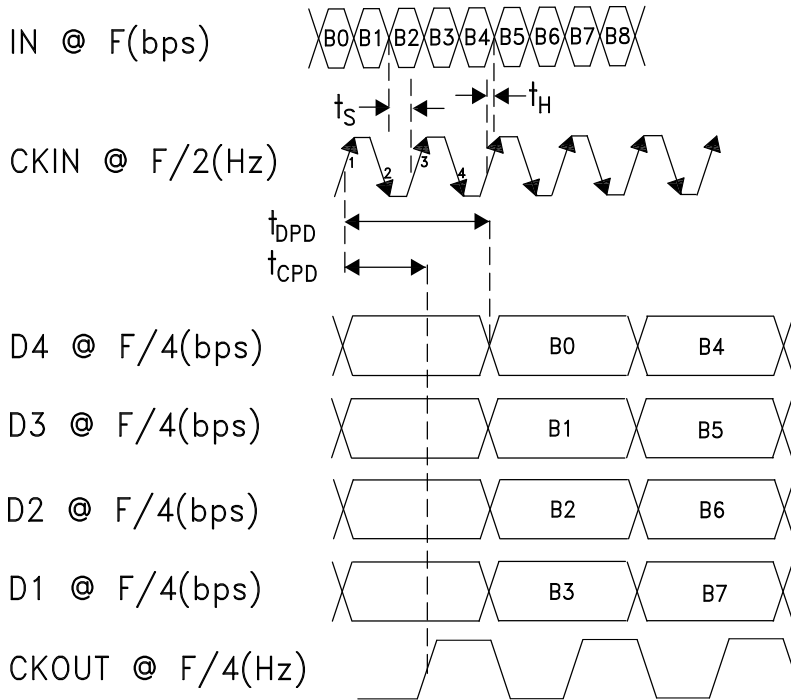

Absolute Maximum Ratings

Power Supply Voltage (Vcc)	3.7V to +0.5V
Input Voltages	Vcc -2V to Vcc +0.5V
DC Control Pins (Vctrl, Vdccc)	Vcc +0.2V to Vcc -2.5V
Channel Temperature	125 °C
Continuous P _{diss} (T = 85 °C) (derate 49.97 mW/°C above 85 °C)	2 W
Thermal Resistance (Channel to die bottom)	20.01 °C/W
Storage Temperature	-65°C to +150°C
Operating Temperature	-40°C to +85°C

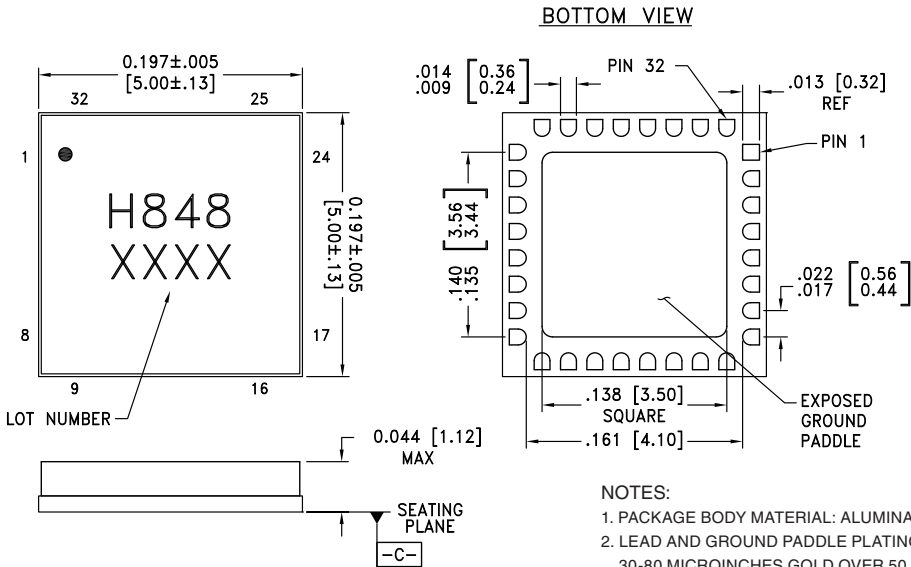

ELECTROSTATIC SENSITIVE DEVICE
OBSERVE HANDLING PRECAUTIONS

Outline Drawing

NOTES:

1. PACKAGE BODY MATERIAL: ALUMINA
2. LEAD AND GROUND PADDLE PLATING:
30-80 MICROINCHES GOLD OVER 50 MICROINCHES MINIMUM NICKEL.
3. DIMENSIONS ARE IN INCHES [MILLIMETERS].
4. LEAD SPACING TOLERANCE IS NON-CUMULATIVE.
5. PACKAGE WARP SHALL NOT EXCEED 0.05mm DATUM -C-
6. ALL GROUND LEADS MUST BE SOLDERED TO PCB RF GROUND.
7. PADDLE MUST BE SOLDERED TO Vee.



Package Information

Part Number	Package Body Material	Lead Finish	MSL Rating	Package Marking ^[2]
HMC848LC5	Alumina, White	Gold over Nickel	MSL3 ^[1]	H848 XXXX

[1] Max peak reflow temperature of 260 °C

[2] 4-Digit lot number XXXX

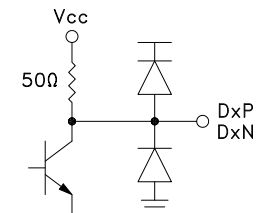
Pin Descriptions

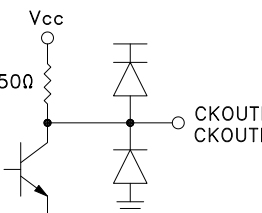
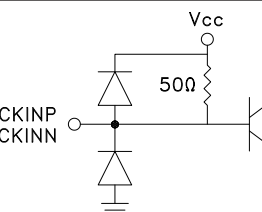
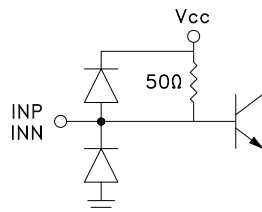
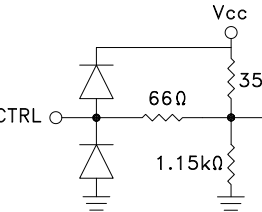
Pin Number	Function	Description	Interface Schematic
1, 10, 16, 24, 26	VCC	Positive supply (3.3V)	
2, 3, 5, 6, 27, 28, 30, 31	D2P, D2N, D4N, D4P, D1P, D1N, D3N, D3P	Differential 4 Channel Serial Data Outputs	
4, 7, 12, 15, 19, 22, 25, 29, 32	GND	Signal and supply ground.	
8, 9	CKOUTN, CKOUTP	Differential Quarter Rate System Clock Outputs.	
11, 17, 18	N/C	Not connected.	
13, 14	CKINN, CKINP	Differential Half Rate Clock Inputs.	
20, 21	INP, INN	High Speed Serial Data Inputs	
23	Vctrl	Output Amplitude Control	

Evaluation PCB

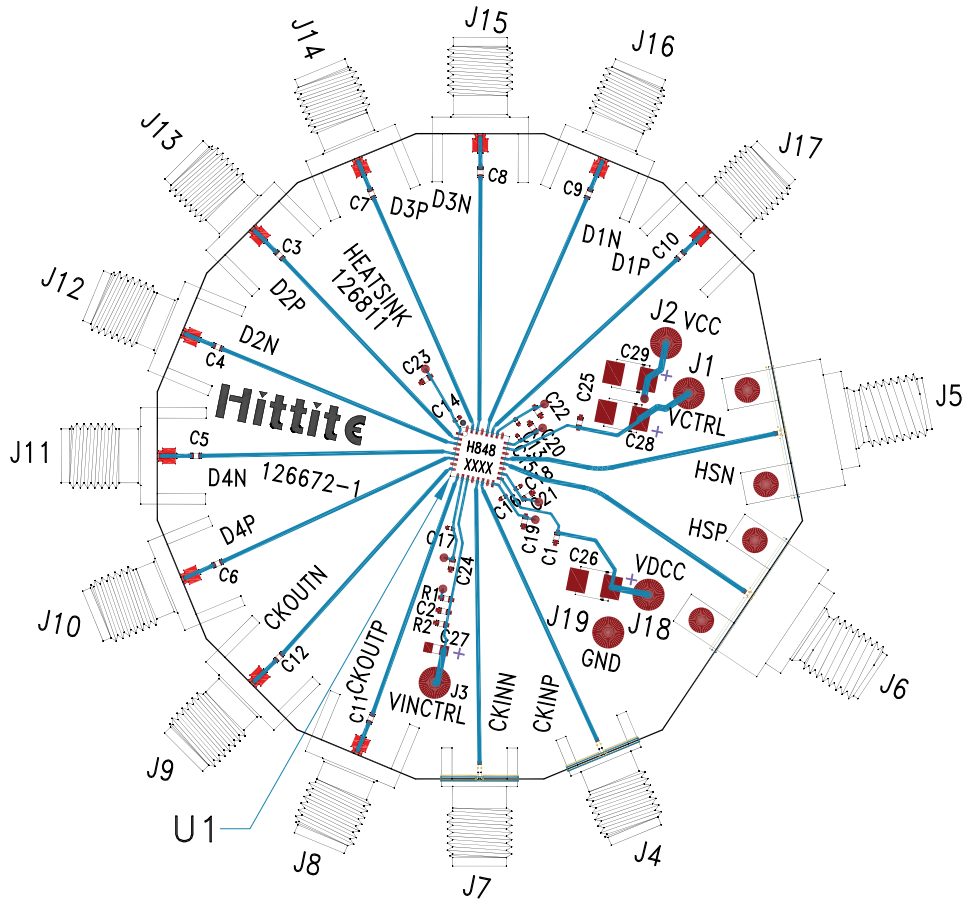

List of Materials for Evaluation PCB 126674 [1]

Item	Description
J1, J2, J18, J19	DC Connector
J4, J7	K Connector
J5, J6	2.4mm Connector
J8 - J17	SMA Connector
C1, C19 - C25	100 nF Capacitor, 0402 Pkg.
C3 - C12	10 nF Capacitor, 0402 Pkg.
C13 - C18	1 nF Capacitor, 0201 Pkg.
C26, C28, C29	4.7 μF Capacitor, Tantalum
U1	HMC848LC5 45 Gbps 1:4 Demux
PCB [2]	126672 Evaluation Board

[1] Reference this number when ordering complete evaluation PCB

[2] Circuit Board Material: Arlon 25FR or Rogers 4350

The circuit board used in the application should use RF circuit design techniques. Signal lines should have 50 Ohm impedance while the package ground leads should be connected directly to the ground plane similar to that shown. The exposed metal package base must be connected to GND. A sufficient number of via holes should be used to connect the top and bottom ground planes. The evaluation circuit board shown is available from Hittite upon request.

45 Gbps, 1:4 DEMUX WITH PROGRAMMABLE OUTPUT VOLTAGE

Application Circuit

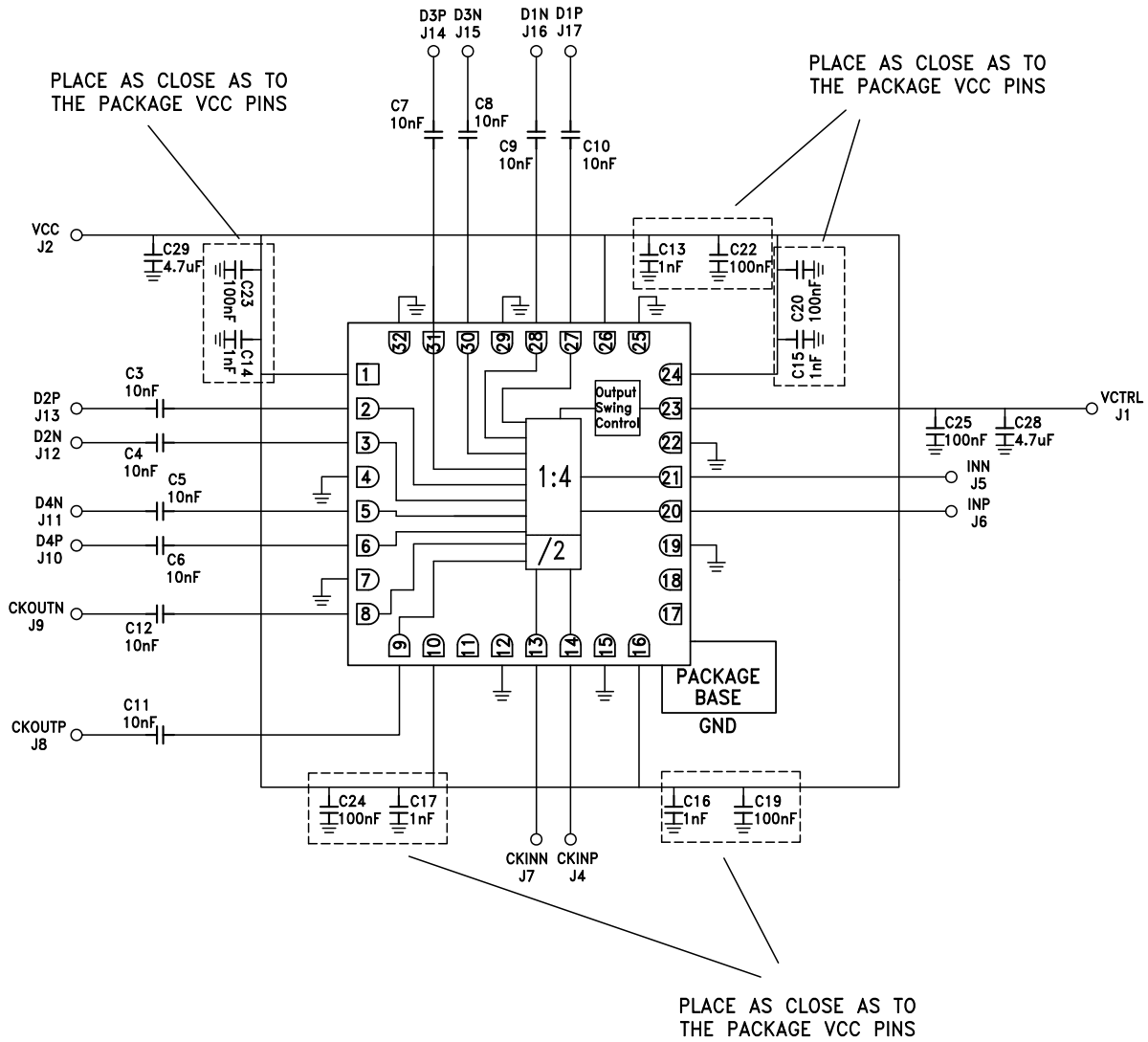



**45 Gbps, 1:4 DEMUX WITH
PROGRAMMABLE OUTPUT VOLTAGE**

Notes:

Mouser Electronics

Authorized Distributor

Click to View Pricing, Inventory, Delivery & Lifecycle Information:

[Analog Devices Inc.:](#)

[HMC848LC5](#) [126674-HMC848LC5](#) [HMC848LC5TR-R5](#) [HMC848LC5TR](#)