



43 Gbps, D-TYPE FLIP-FLOP w/ PROGRAMMABLE OUTPUT VOLTAGE

Typical Applications

The HMC841LC4B is ideal for:

- OC-768 and SDH STM-256 Equipment
- RF ATE Applications
- Serial Data Transmission up to 43 Gbps
- Digital Logic Systems up to 43 Gbps
- Broadband Test & Measurement

Features

- Supports Data Rates up to 43 Gbps
- Low Power Consumption: 630 mW
- Fast Rise and Fall Times: 12/12 ps
- Single Ended or Differential Operation
- Adjustable Differential Output Voltage Swing: 200 - 850 mVp-p
- 24 Lead 4x4mm SMT Package: 16mm²

Functional Diagram

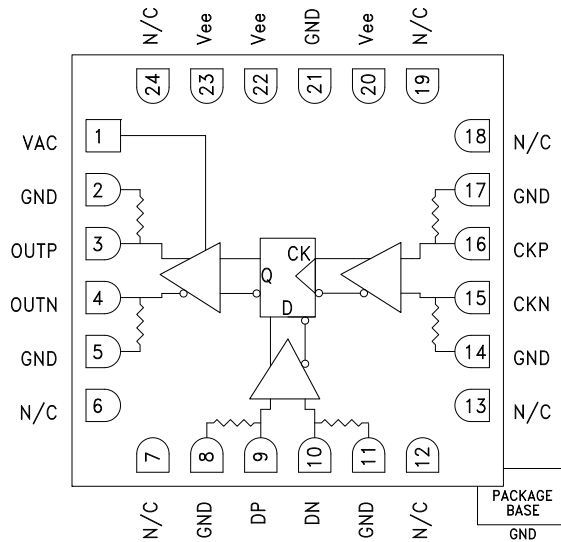

General Description

The HMC841LC4B is a D-type Flip Flop designed to support data transmission rates of up to 43 Gbps, and clock frequencies as high as 43 GHz. During normal operation, data is transferred to the outputs on the positive edge of the clock. Reversing the clock inputs allows for negative-edge triggered applications. The HMC841LC4B also features an output level control pin, VAC, which allows for loss compensation or for signal level optimization.

All input signals to the HMC841LC4B are terminated with 50 Ohms to ground on-chip, and maybe either AC or DC coupled. The differential outputs of the HMC841LC4B may be either AC or DC coupled. Outputs can be connected directly to a 50 Ohms-to-ground terminated system, while DC blocking capacitors should be used if the terminating system is 50 Ohms to a non-ground DC voltage. The HMC841LC4B operates from a single -3.3V DC supply and is available in a ceramic RoHS compliant 4x4 mm SMT package.

Electrical Specifications, $T_A = +25^\circ\text{C}$, $V_{ee} = -3.3\text{V}$

Parameter	Conditions	Min.	Typ.	Max	Units
Power Supply Voltage	$\pm 5\%$ Tolerance	-3.47	-3.3	-3.13	V
Power Supply Current	VAC = -0.3V	160	190	220	mA
Output Amplitude Control Voltage VAC ⁽¹⁾		-1.6	-0.3	-0.1	V
Maximum Data Rate		43			Gbps
Maximum Clock Rate		43			GHz
Input Amplitude (Data)	Single-ended, peak-to-peak	200		500	mVp-p
	Differential, peak-to-peak	200		1000	
Input Amplitude (Clock)	Single-ended, peak-to-peak	400		800	mVp-p
	Differential, peak-to-peak	250		1000	
Input High Voltage (Data & Clock)		-0.5		0.5	V

Information furnished by Analog Devices is believed to be accurate and reliable. However, no responsibility is assumed by Analog Devices for its use, nor for any infringements of patents or other rights of third parties that may result from its use. Specifications subject to change without notice. No license is granted by implication or otherwise under any patent or patent rights of Analog Devices. Trademarks and registered trademarks are the property of their respective owners.

For price, delivery, and to place orders: Analog Devices, Inc., One Technology Way, P.O. Box 9106, Norwood, MA 02062-9106 Phone: 781-329-4700 • Order online at www.analog.com Application Support: Phone: 1-800-ANALOG-D



43 Gbps, D-TYPE FLIP-FLOP w/ PROGRAMMABLE OUTPUT VOLTAGE

Electrical Specifications, (continued)

Parameter	Conditions	Min.	Typ.	Max	Units
Input Low Voltage (Data & Clock)		-1		0	V
Output Amplitude	Differential, peak-to-peak @ 40 Gbps	200		850	mVp-p
Output High Voltage		VAC = -0.3	-50		mV
Output Low Voltage		VAC = -0.3	-550		mV
Input Return Loss	Data input up to 25 GHz		10		dB
	Clock input up to 40 GHz		6		dB
Output Return Loss	Data output up to 25 GHz		10		dB
Deterministic Jitter, Jd [2]			2		ps, pp
Additive Random Jitter Jr [3]			0.2		ps rms
Rise Time, tr [2]			12		ps
Fall Time, tf [2]			12		ps
Propagation Delay, td	Clock to output delay		10		ps
Clock Phase Margin	@ 40 Gbps		270		deg

[1] VAC = VC2 on evaluation board.

[2] Clock Input: 40 GHz clock signal, 200 mVp-p single-ended, Data Input: 40 Gbps PRBS 2²³-1 pattern, 200 mVp-p single-ended

[3] Random jitter is measured with 40 Gbps 10101... pattern

DC Current vs. Supply Voltage [1] [2]

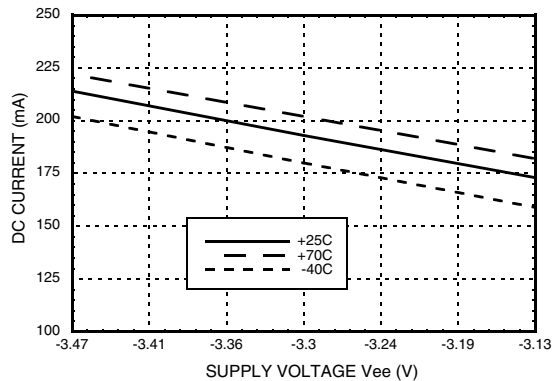

Differential Output Swing vs. Supply Voltage [1] [2]

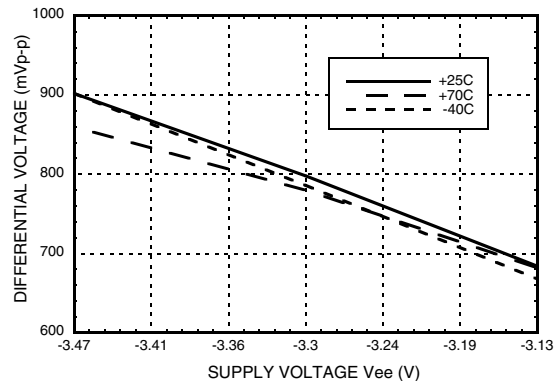

DC Current vs. VAC [2]

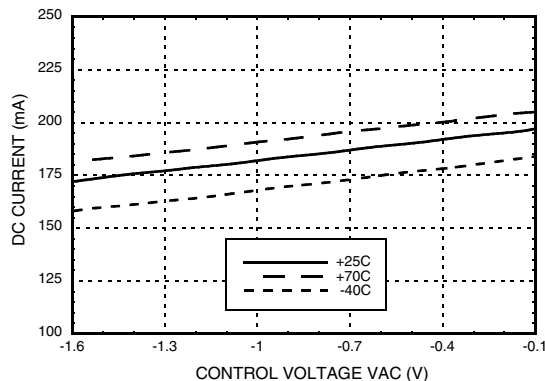

Differential Output Swing vs. VAC [2]

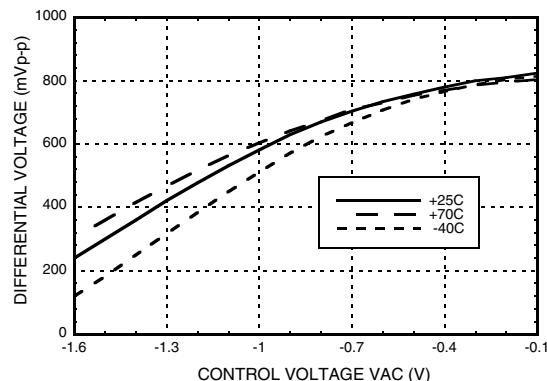

[1] VAC = -0.3V

[2] Input data rate: 40 Gbps PRBS 2²³-1



**43 Gbps, D-TYPE FLIP-FLOP
w/ PROGRAMMABLE OUTPUT VOLTAGE**

Rise Time vs. Supply Voltage [1][2][3]

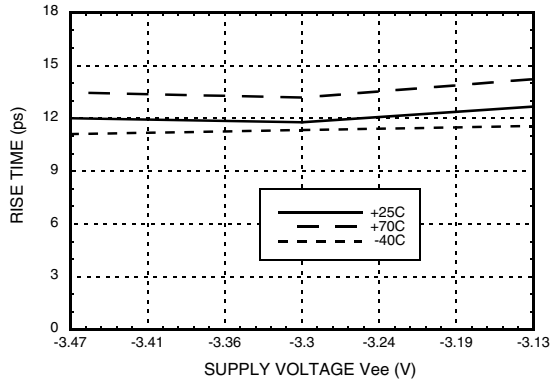

Fall Time vs. Supply Voltage [1][2][3]

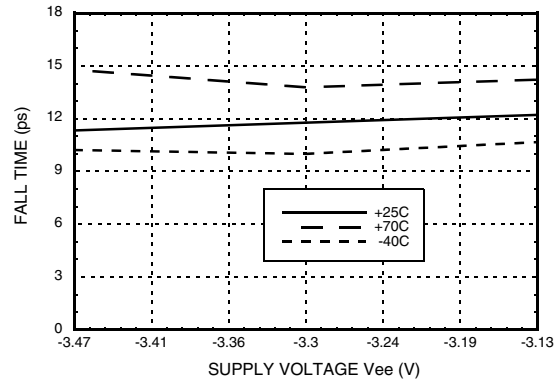

Rise / Fall Time vs. VAC [1][2][3]

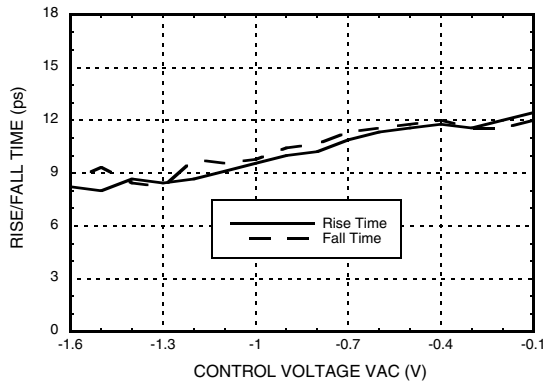

Peak-to-Peak Jitter vs. Supply Voltage [1][2][3][4]

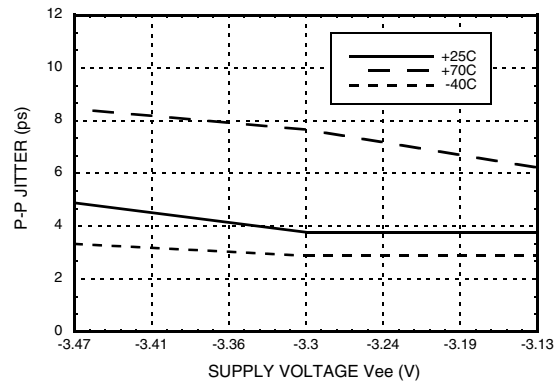

Input Return Loss vs. Frequency [1][5]

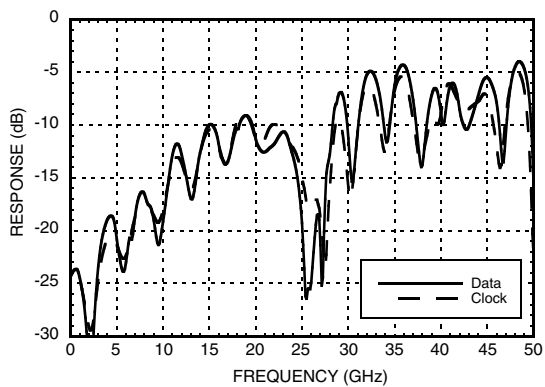

Output Return Loss vs. Frequency [1][5]

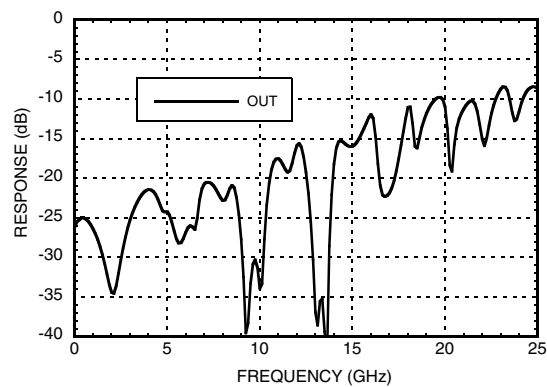

[1] VAC = -0.3V [2] Input data rate: 40 Gbps PRBS 2²³-1 [3] Data was taken at single ended output
 [4] Source jitter was not deembedded [5] Device measured on evaluation board with single-ended time domain gating.

Information furnished by Analog Devices is believed to be accurate and reliable. However, no responsibility is assumed by Analog Devices for its use, nor for any infringements of patents or other rights of third parties that may result from its use. Specifications subject to change without notice. No license is granted by implication or otherwise under any patent or patent rights of Analog Devices. Trademarks and registered trademarks are the property of their respective owners.

For price, delivery, and to place orders: Analog Devices, Inc., One Technology Way, P.O. Box 9106, Norwood, MA 02062-9106 Phone: 781-329-4700 • Order online at www.analog.com Application Support: Phone: 1-800-ANALOG-D



**43 Gbps, D-TYPE FLIP-FLOP
w/ PROGRAMMABLE OUTPUT VOLTAGE**

40 Gbps Differential Output Eye Diagram

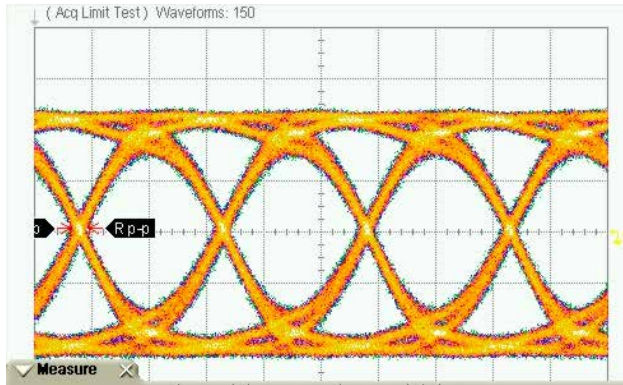

Measurements				
	Current	Minimum	Maximum	Total Meas
Eye Amp	774 mV	772 mV	774 mV	42
Rise Time	11.78 ps	10.56 ps	12.00 ps	42
Fall Time	11.78 ps	10.56 ps	12.00 ps	42
p-p jitter	3.333 ps	2.889 ps	3.556 ps	42

Time Scale: 10 ps/div
Amplitude Scale: 200 mV/div

Test Conditions:
Vee = -3.3V, VAC = -0.3V
Data Input: Single-ended 150 mVp-p 40 Gbps NRZ PRBS 2²³-1 pattern
Clock Input: Single-ended 150 mVp-p 40 GHz clock signal

Timing Diagram

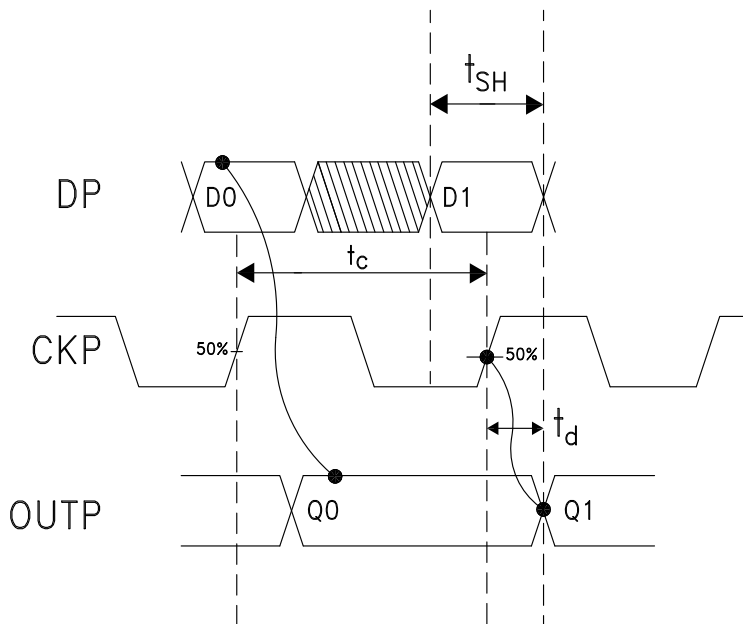

$$t_c = \frac{1}{f_{\text{clock}}}$$

t_{SH} = Setup and Hold Time

$$\text{CPM} = \text{Clock Phase Margin} = 360^\circ \frac{t_c - t_{SH}}{t_c}$$

Truth Table

Input		Outputs
D	C	Q
L	L -> H	L
H	L -> H	H
Notes: D = DP - DN C = CKP - CKN Q = OUTP - OUTN		H - Logic High L - Logic Low



43 Gbps, D-TYPE FLIP-FLOP w/ PROGRAMMABLE OUTPUT VOLTAGE

Absolute Maximum Ratings

Power Supply Voltage (Vee)	-3.7V to +0.5V
Input Voltage	-1.3V to +0.5V
Channel Temperature	125°C
Continuous Pdiss (T = 85°C) (derate 29.04 mW/°C above 85°C)	1.16 W
Thermal Resistance (channel to ground paddle)	34.44 °C/W
Storage Temperature	-65°C to +125°C
Operating Temperature	-40°C to +70°C
Output Amplitude Control Voltage (VAC)	-2.3V to +0.5V



ELECTROSTATIC SENSITIVE DEVICE
OBSERVE HANDLING PRECAUTIONS

Outline Drawing

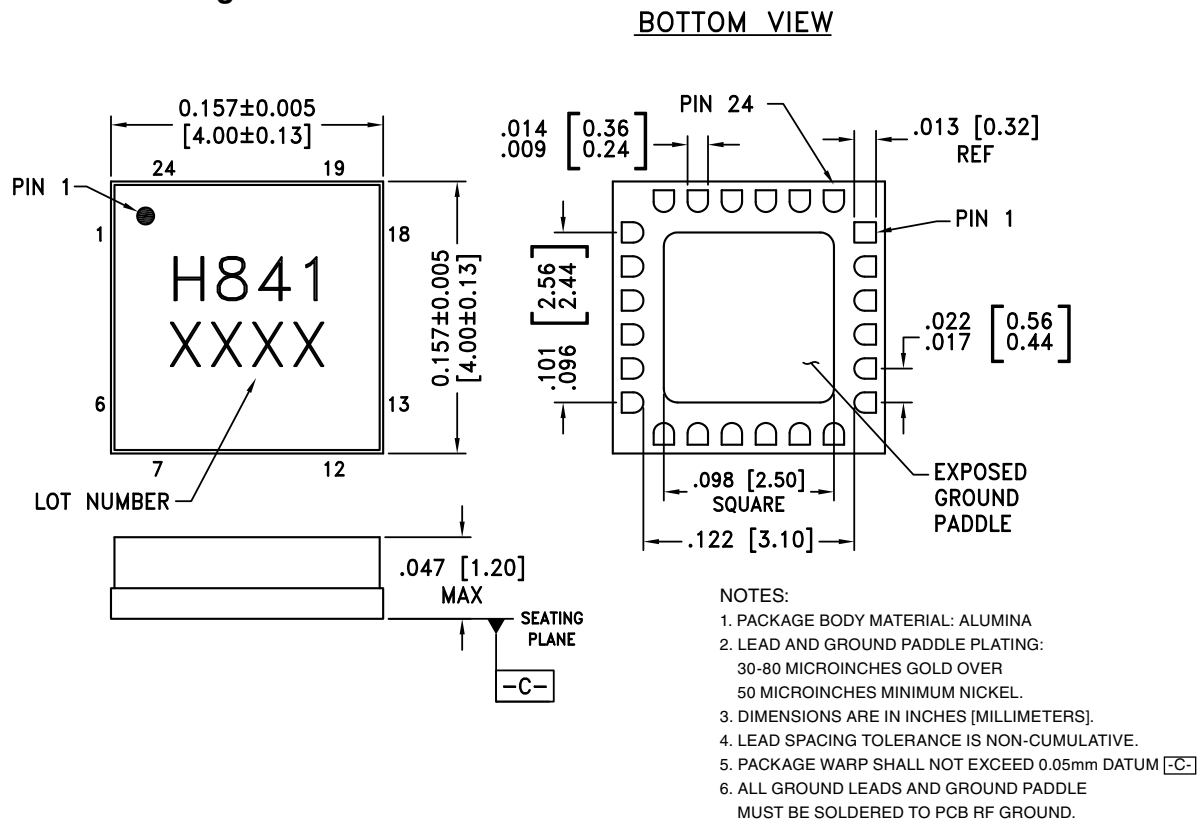

Package Information

Part Number	Package Body Material	Lead Finish	MSL Rating	Package Marking ^[2]
HMC841LC4B	Alumina, White	Gold over Nickel	MSL3 ^[1]	H841 XXXX

[1] Max peak reflow temperature of 260 °C

[2] 4-Digit lot number XXXX



43 Gbps, D-TYPE FLIP-FLOP w/ PROGRAMMABLE OUTPUT VOLTAGE

Pin Descriptions

Pin Number	Function	Description	Interface Schematic
1	VAC	Output Amplitude Control Voltage. Note: VAC = VC2 on evaluation board.	
2, 5, 8, 11, 14, 17, 21 Package Base	GND	Signal and supply grounds	
3, 4	OUTP, OUTN	DFF differential (OUTP-OUTN) or single ended (OUTP) outputs	
6, 7, 12, 13, 18, 19, 24	N/C	The pins are not connected internally; however, all data shown herein was measured with these pins connected to RF/DC ground externally.	
9, 10	DP, DN	DFF differential (DP-DN) or single ended (DP) data inputs	
15, 16	CKN, CKP	DFF differential (CKP-CKN) or single ended (CKP) clock inputs.	
20, 22, 23	Vee	Power Supply (-3.3V)	



**43 Gbps, D-TYPE FLIP-FLOP
w/ PROGRAMMABLE OUTPUT VOLTAGE**

Evaluation PCB

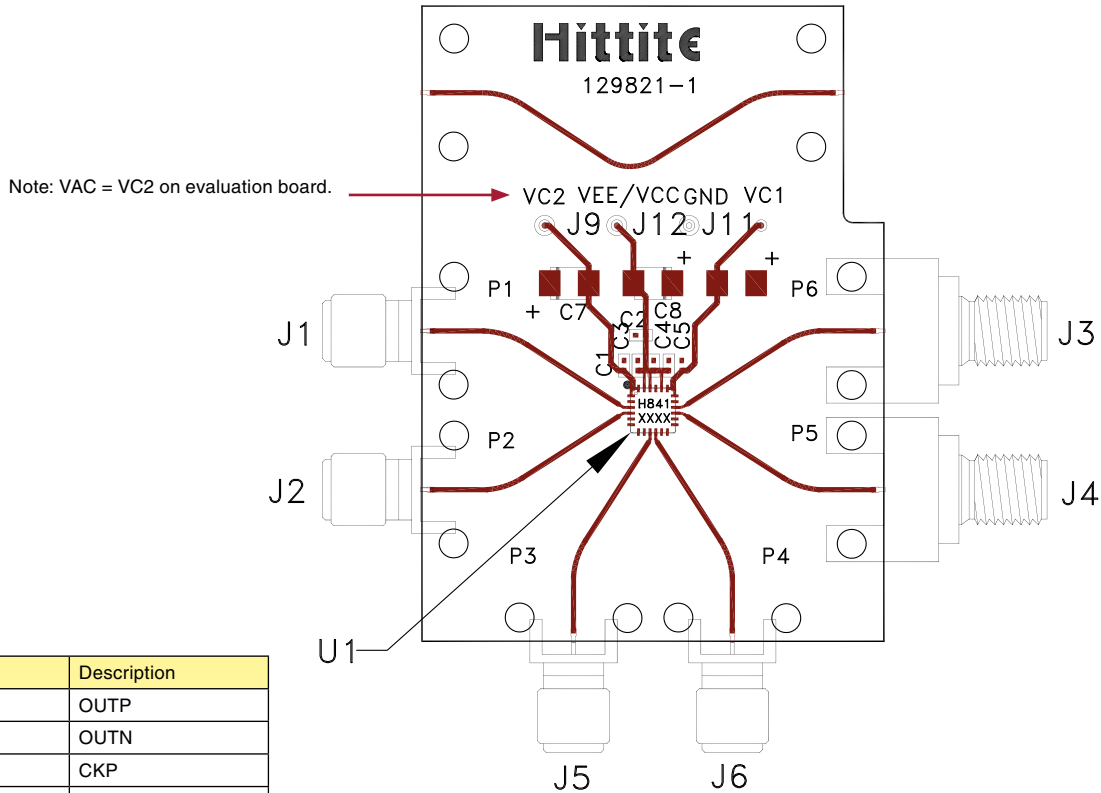

Item	Description
J1	OUTP
J2	OUTN
J3	CKP
J4	CKN
J5	DP
J6	DN
J9	VAC
J11	GND
J12	Vee

List of Materials for Evaluation PCB 129126 [1]

Item	Description
J1, J2, J5, J6	K Connector
J3, J4	2.4mm Connector
J9, J11, J12	DC Pin
C1, C3 - C5	1000 pF Capacitor, 0402 Pkg.
C2	0.1 μF Capacitor, 0402 Pkg.
C7, C8	4.7 μF Capacitor, Tantalum
U1	HMC841LC4B High Speed Logic, D-Type Flip-Flop
PCB [2]	129821 Evaluation Board

[1] Reference this number when ordering complete evaluation PCB

[2] Circuit Board Material: Arlon 25FR or Rogers 4350

The circuit board used in the application should use RF circuit design techniques. Signal lines should have 50 Ohm impedance while the package ground leads should be connected directly to the ground plane similar to that shown. The exposed metal package base must be connected to Vee. A sufficient number of via holes should be used to connect the top and bottom ground planes. The evaluation circuit board shown is available from Hittite upon request.



**43 Gbps, D-TYPE FLIP-FLOP
w/ PROGRAMMABLE OUTPUT VOLTAGE**

Application Circuit

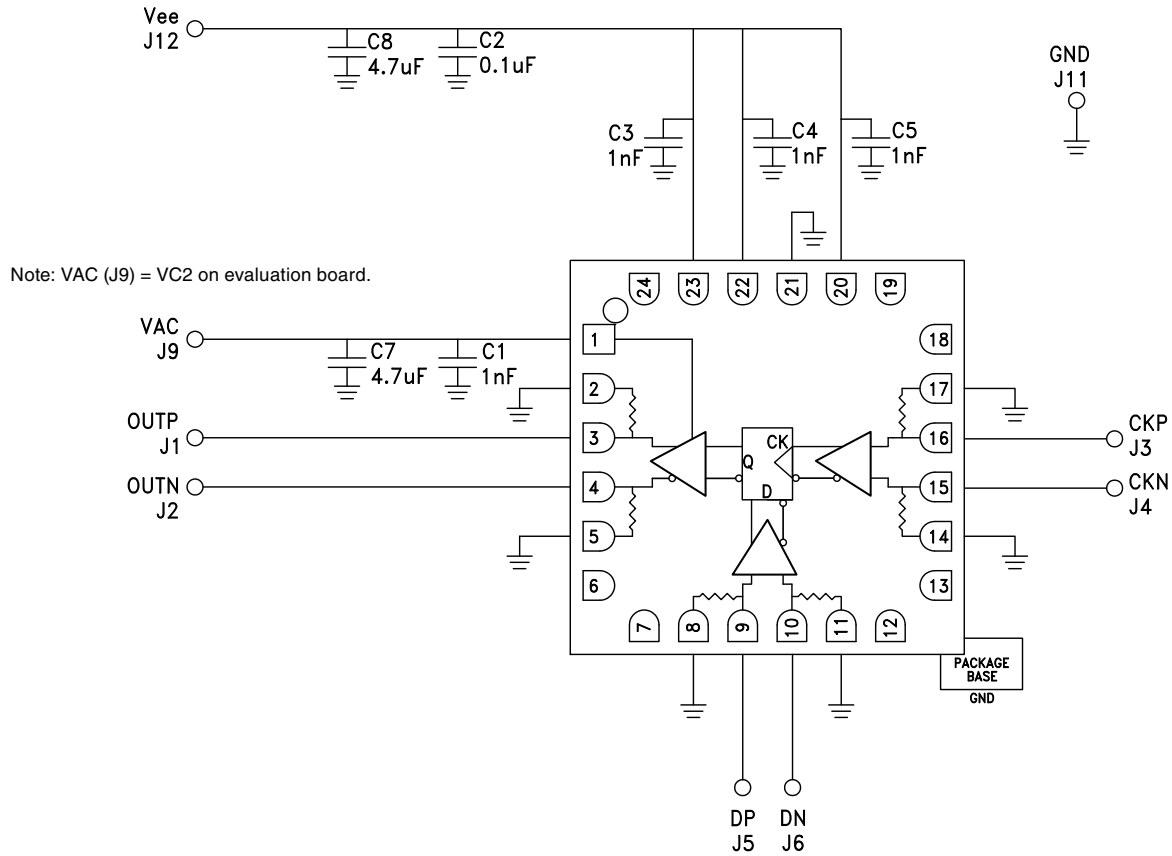

Mouser Electronics

Authorized Distributor

Click to View Pricing, Inventory, Delivery & Lifecycle Information:

[Analog Devices Inc.:](#)

[129126-HMC841LC4B](#) [HMC841LC4B](#) [HMC841LC4BTR](#) [HMC841LC4BTR-R5](#)