

# Analog Devices Welcomes Hittite Microwave Corporation

NO CONTENT ON THE ATTACHED DOCUMENT HAS CHANGED



**THIS PAGE INTENTIONALLY LEFT BLANK**



## GaAs MMIC VOLTAGE-VARIABLE ATTENUATOR, 5 - 30 GHz

### Typical Applications

The HMC812LC4 is ideal for:

- Point-to-Point Radio
- VSAT Radio
- Test Instrumentation
- Microwave Sensors
- Military, ECM & Radar

### Functional Diagram

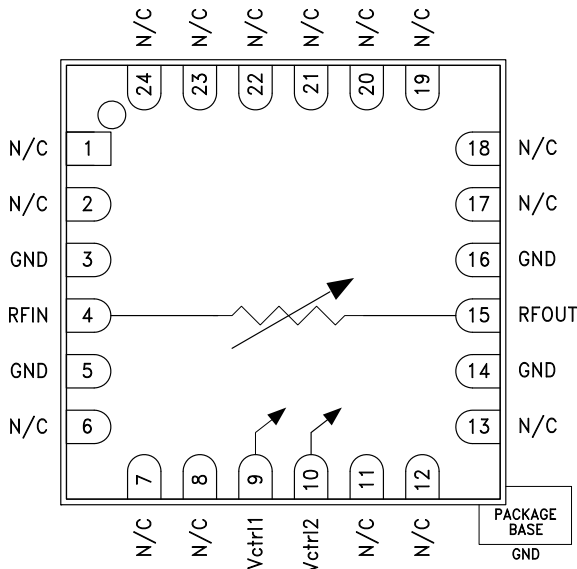

### Features

- Wide Bandwidth: 5 - 30 GHz
- Excellent Linearity: +28 dBm Input IP3
- High Power Handling: +25 dBm Input P1dB
- Wide Attenuation Range: 30 dB
- 24 Lead Ceramic 4x4 mm SMT Package: 16mm<sup>2</sup>

### General Description

The HMC812LC4 is an absorptive Voltage Variable Attenuator (VVA) which operates from 5 - 30 GHz and is ideal in designs where an analog DC control signal must be used to control RF signal levels over a 30 dB amplitude range. It features two shunt-type attenuators which are controlled by two analog voltages, Vctrl1 and Vctrl2. Optimum linearity performance of the attenuator is achieved by first varying Vctrl1 of the 1st attenuation stage from -3V to 0V with Vctrl2 fixed at -3V. The control voltage of the 2nd attenuation stage, Vctrl2, should then be varied from -3V to 0V, with Vctrl1 fixed at 0V. The HMC812LC4 is housed in a RoHS compliant 4x4 mm QFN leadless ceramic package

However, if the Vctrl1 and Vctrl2 pins are connected together it is possible to achieve the full analog attenuation range with only a small degradation in input IP3 performance. Applications include AGC circuits and temperature compensation of multiple gain stages in microwave point-to-point and VSAT radios.

### Electrical Specifications, $T_A = +25^\circ C$ , 50 Ohm system

Parameter	Min.	Typ.	Max.	Units
Insertion Loss		5 - 16 GHz	2	dB
		16 - 24 GHz	3	dB
		24 - 30 GHz	4	dB
Attenuation Range		30		dB
Input Return Loss		12		dB
Output Return Loss		8		dB
Input Power for 1 dB Compression (any attenuation)		25		dBm
Input Third Order Intercept (Two-tone Input Power = 10 dBm Each Tone)		28		dBm



## GaAs MMIC VOLTAGE-VARIABLE ATTENUATOR, 5 - 30 GHz

**Attenuation vs. Frequency over Vctrl**  
Vctrl1 = Variable, Vctrl2 = -3V

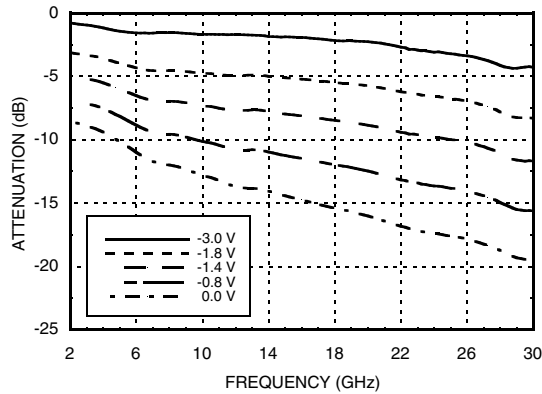

**Attenuation vs. Frequency over Vctrl**  
Vctrl1 = 0V, Vctrl2 = Variable

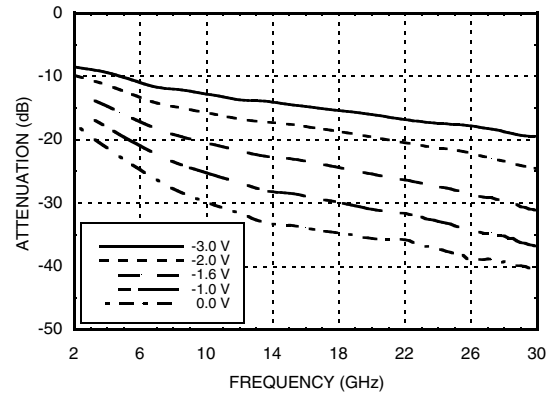

**Attenuation vs. Vctrl1**  
Over Temperature @ 10 GHz, Vctrl2 = -3V

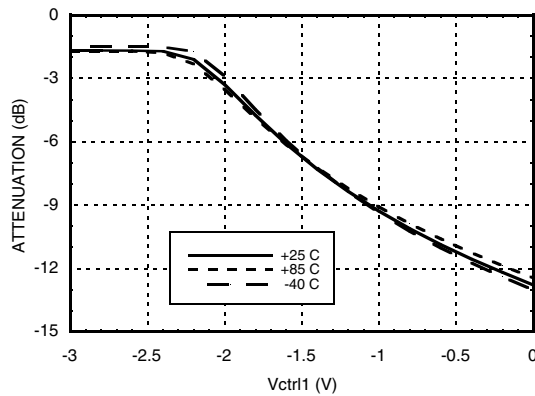

**Attenuation vs. Vctrl2**  
Over Temperature @ 10 GHz, Vctrl1 = 0V

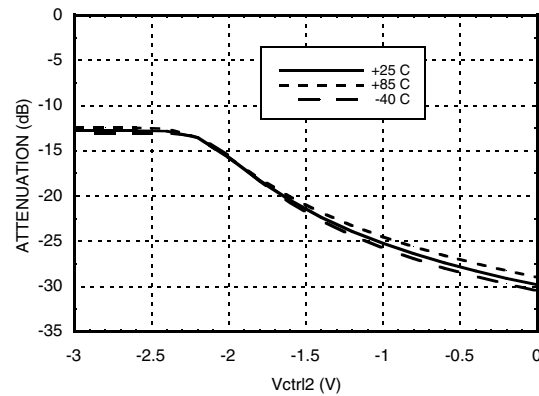

**Attenuation vs. Pin @ 10 GHz**  
Vctrl1 = Variable, Vctrl2 = -3V

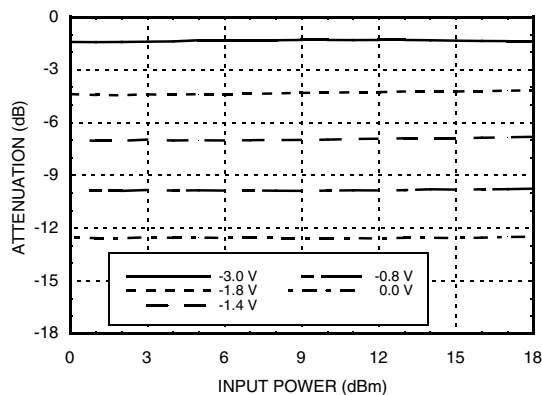

**Input Return Loss**  
Vctrl1 = Variable, Vctrl2 = -3V

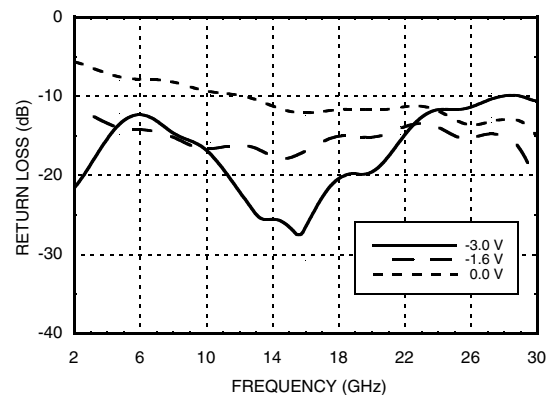



## GaAs MMIC VOLTAGE-VARIABLE ATTENUATOR, 5 - 30 GHz

### Input Return Loss

$V_{ctrl1} = 0V$ ,  $V_{ctrl2} = \text{Variable}$

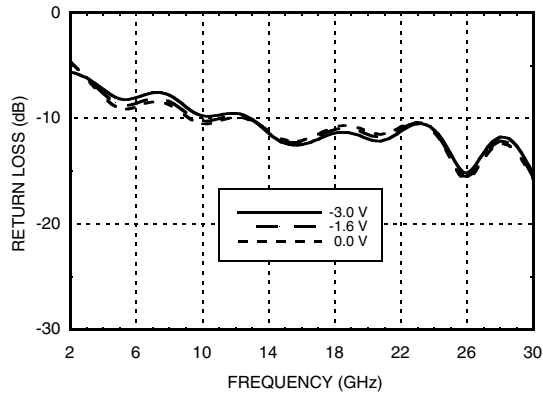

### Output Return Loss

$V_{ctrl1} = \text{Variable}$ ,  $V_{ctrl2} = -3V$

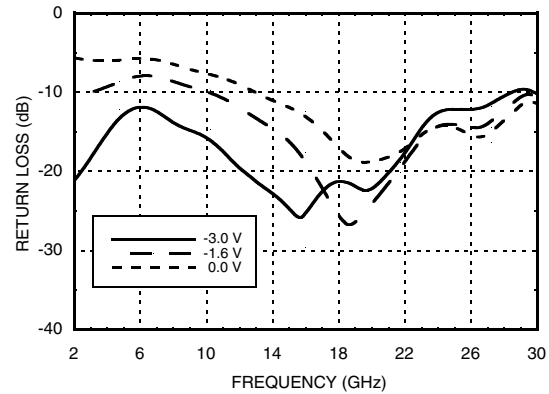

### Output Return Loss

$V_{ctrl1} = 0V$ ,  $V_{ctrl2} = \text{Variable}$

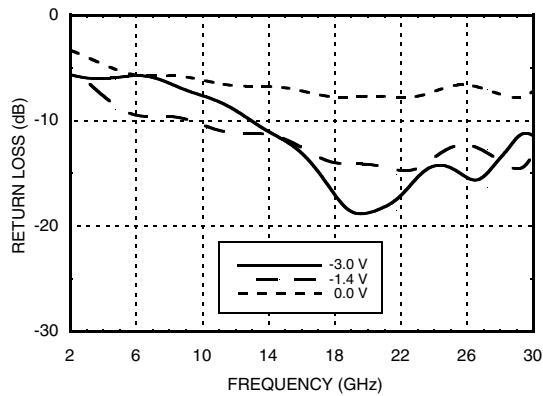

### Input IP3 vs Input Power @ 10 GHz

$V_{ctrl1} = \text{Variable}$ ,  $V_{ctrl2} = -3V$

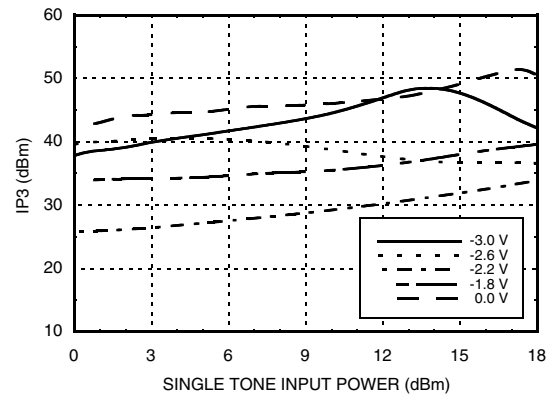

### Input IP3 vs. Input Power Over Frequency

$V_{ctrl1} = -2.2V$ ,  $V_{ctrl2} = -3V$  (Worst Case IP3)

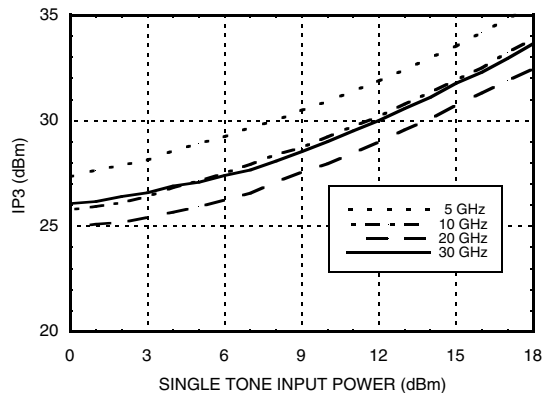

### Input IP3 vs. Input Power Over Temperature

@ 10 GHz,  $V_{ctrl1} = -2.2V$ ,  $V_{ctrl2} = -3V$

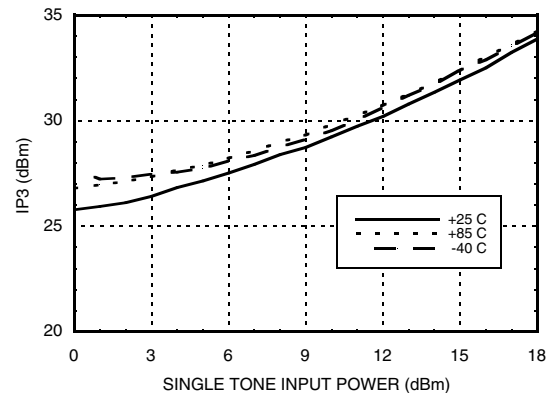



## GaAs MMIC VOLTAGE-VARIABLE ATTENUATOR, 5 - 30 GHz

**Attenuation vs. Frequency over Vctrl**  
Vctrl1 = Vctrl2

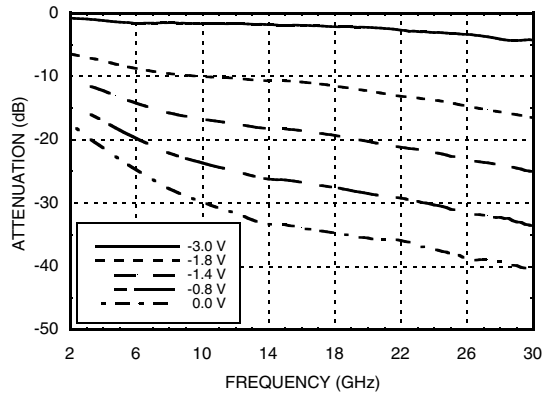

**Attenuation vs. Vctrl over Temperature**  
@ 10 GHz, Vctrl1 = Vctrl2

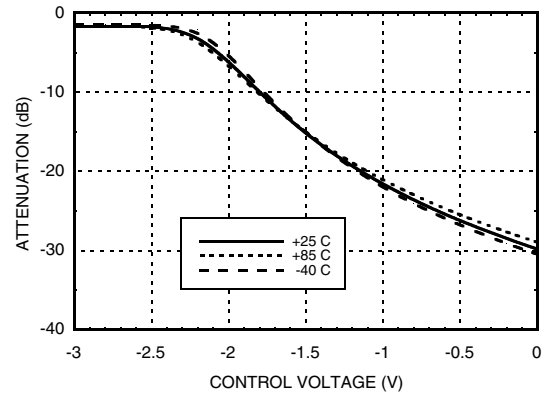

**Attenuation vs. Input Power over Vctrl**  
Vctrl1 = Vctrl2

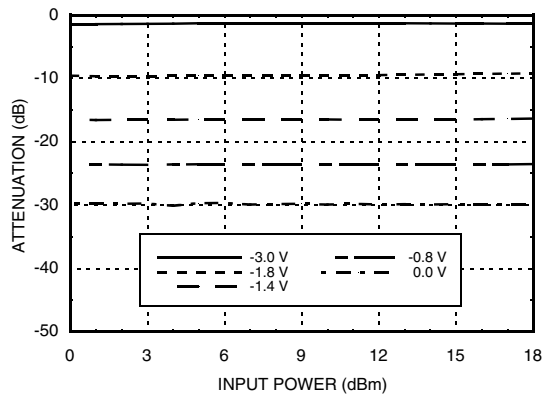

**Input Return Loss, Vctrl1 = Vctrl2**

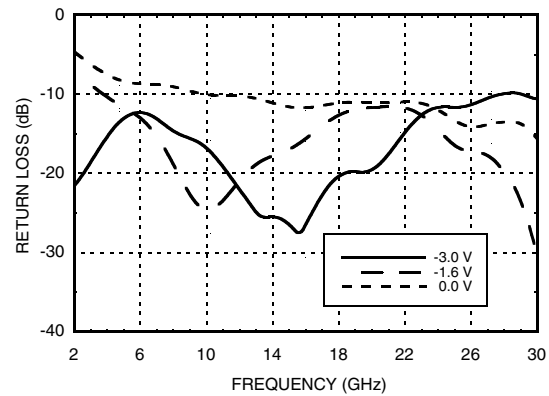

**Output Return Loss, Vctrl1 = Vctrl2**

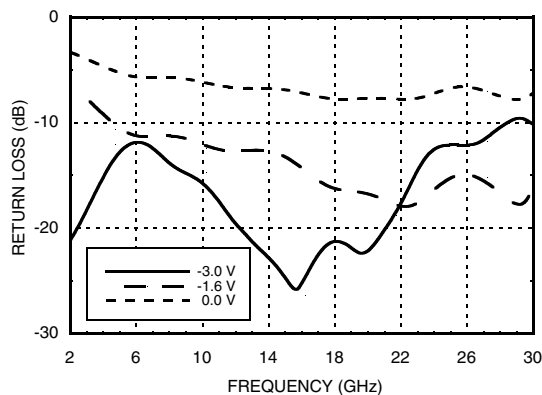

**Input IP3 vs. Input Power Over Vctrl @ 10 GHz, Vctrl1 = Vctrl2**

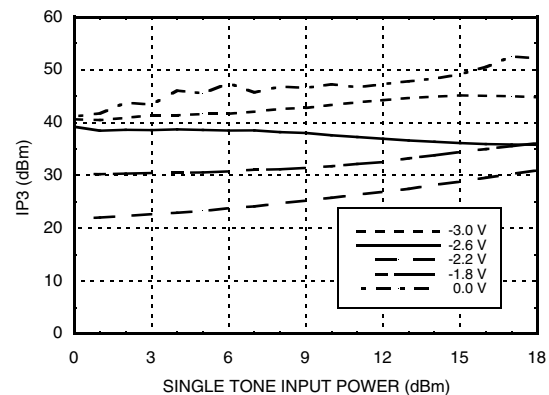

**GaAs MMIC VOLTAGE-VARIABLE  
ATTENUATOR, 5 - 30 GHz**
**Absolute Maximum Ratings**

RF Input Power	+30 dBm
Control Voltage Range	+1 to -5V
Channel Temperature	150 °C
Continuous Pdiss (T = 85 °C) (derate 16.4 mW/ °C above 85 °C)	1.07 W
Thermal Resistance (Channel to ground paddle)	61 °C/W
Storage Temperature	-65 to +150 °C
Operating Temperature	-40 to +85 °C

**Control Voltages**

Vctrl1	-3 to 0V @ 10 µA
Vctrl2	-3 to 0V @ 10 µA

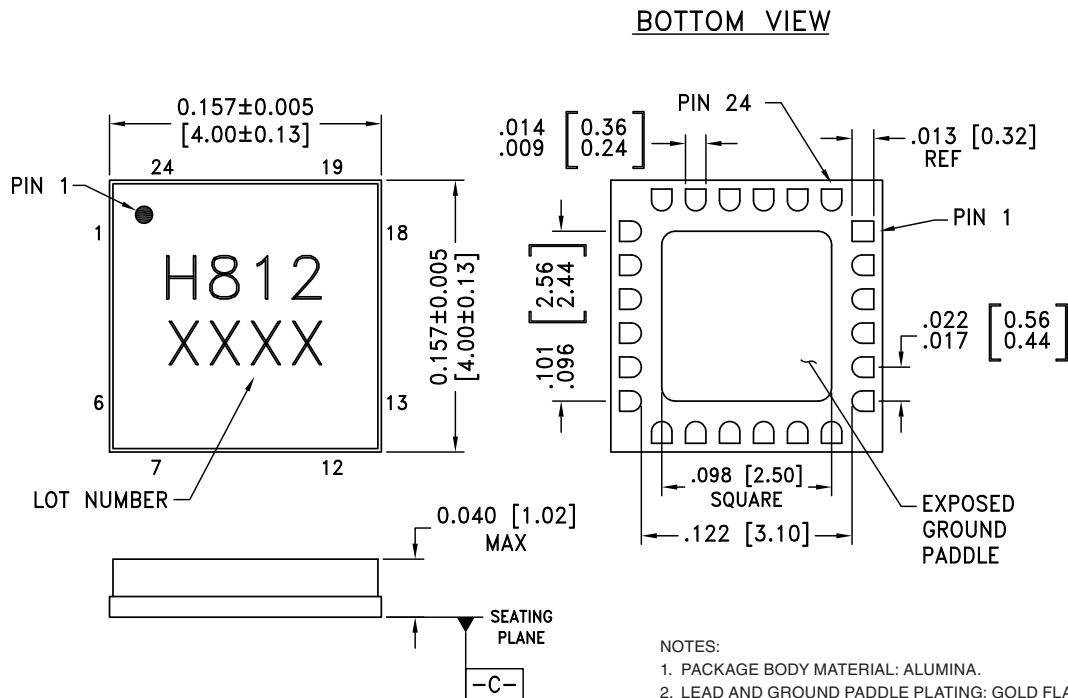
**ELECTROSTATIC SENSITIVE DEVICE  
OBSERVE HANDLING PRECAUTIONS**
**Outline Drawing**

**NOTES:**

- PACKAGE BODY MATERIAL: ALUMINA.
- LEAD AND GROUND PADDLE PLATING: GOLD FLASH OVER NICKEL.
- DIMENSIONS ARE IN INCHES (MILLIMETERS).
- LEAD SPACING TOLERANCE IS NON-CUMULATIVE.
- PACKAGE WARP SHALL NOT EXCEED 0.05MM DATUM -C-
- ALL GROUND LEADS AND GROUND PADDLE MUST BE SOLDERED TO PCB RF GROUND.

**Package Information**

Part Number	Package Body Material	Lead Finish	MSL Rating	Package Marking <sup>[2]</sup>
HMC812LC4	Alumina, White	Gold over Nickel	MSL3 <sup>[1]</sup>	H812 XXXX

[1] Max peak reflow temperature of 260 °C

[2] 4-Digit lot number XXXX

For price, delivery and to place orders: Hittite Microwave Corporation, 2 Elizabeth Drive, Chelmsford, MA 01824

Phone: 978-250-3343 Fax: 978-250-3373 Order On-line at [www.hittite.com](http://www.hittite.com)

Application Support: Phone: 978-250-3343 or [apps@hittite.com](mailto:apps@hittite.com)

**GaAs MMIC VOLTAGE-VARIABLE  
ATTENUATOR, 5 - 30 GHz**
**Pin Descriptions**

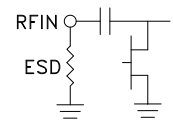
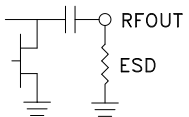
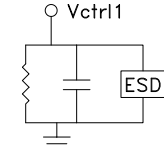
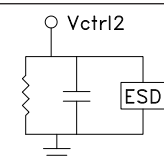
Pin Number	Function	Description	Interface Schematic
1, 2, 6 - 8, 11 - 13, 17 - 24	N/C	These pins are not connected internally, however these pins must be connected to RF/DC ground externally.	
3, 5, 14, 16	GND	These pins and the exposed ground paddle must be connected to RF/DC ground.	
4	RFIN	This pad is DC coupled and matched to 50 Ohms. A blocking capacitor is required if RF line potential is not equal to 0V.	
15	RFOUT		
9	Vctrl1	Control Voltage 1	
10	Vctrl2	Control Voltage 2	

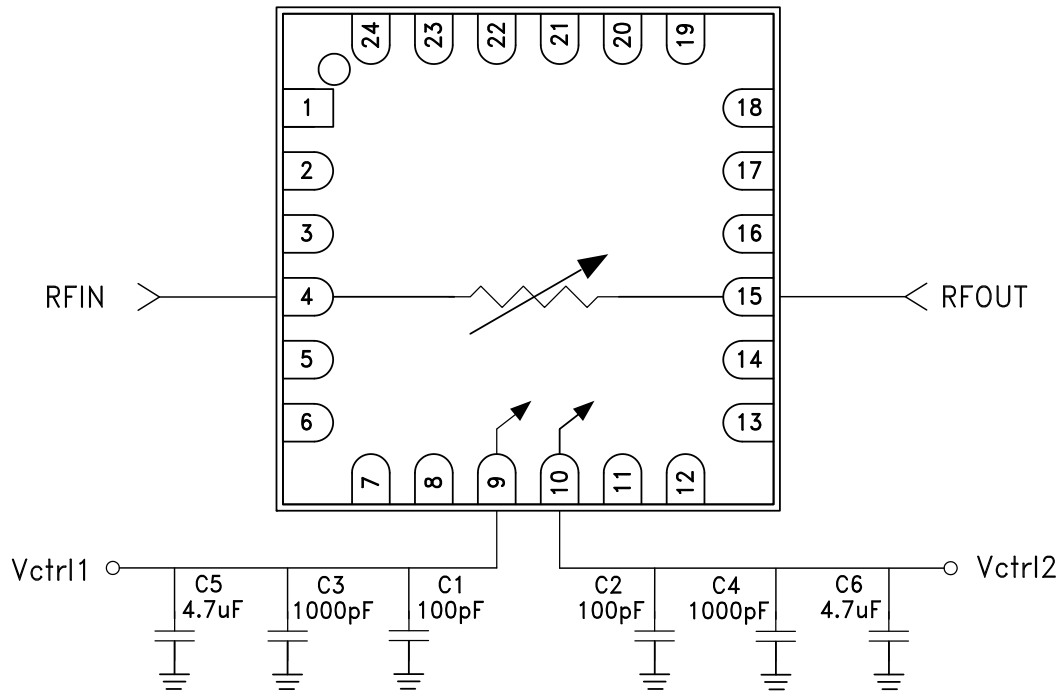

**GaAs MMIC VOLTAGE-VARIABLE  
ATTENUATOR, 5 - 30 GHz****Application Circuit**



## GaAs MMIC VOLTAGE-VARIABLE ATTENUATOR, 5 - 30 GHz

### Evaluation PCB

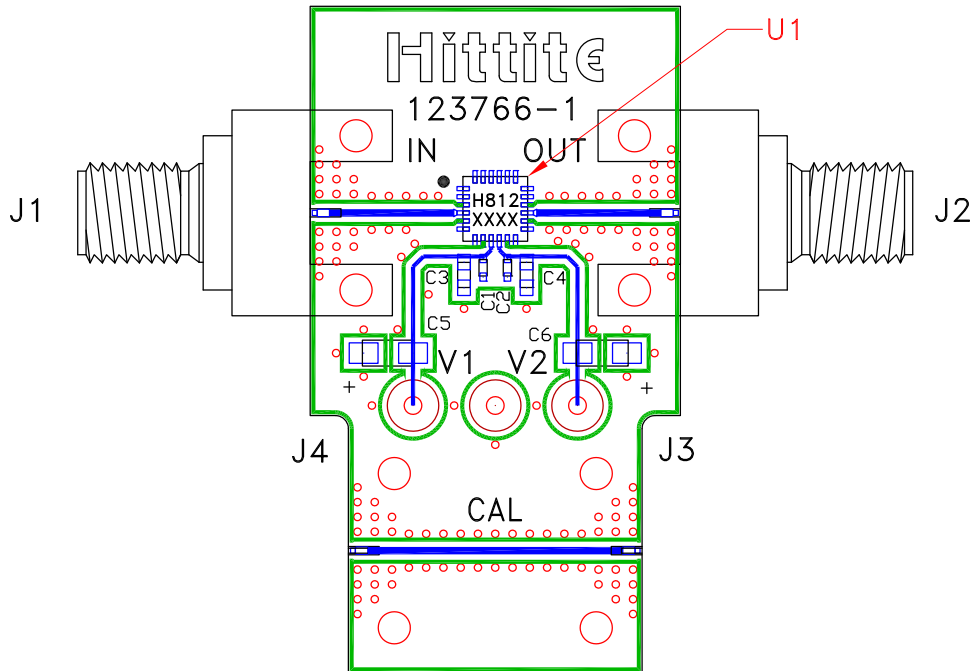

### List of Materials for Evaluation PCB 123768 [1]

Item	Description
J1, J2	2.9 mm PC Mount RF Connector
J3, J4	DC Pin
C1, C2	100 pF Capacitor, 0402 Pkg.
C3, C4	1000 pF Capacitor, 0402 Pkg.
C5, C6	4.7 μF Capacitor, CASE A
U1	HMC812LC4 Analog VVA
PCB [2]	123766 Evaluation PCB

[1] Reference this number when ordering complete evaluation PCB

[2] Circuit Board Material: Arlon 25FR or Rogers 4350

The circuit board used in the final application should use RF circuit design techniques. Signal lines should have 50 Ohm impedance while the package ground leads and exposed paddle should be connected directly to the ground plane similar to that shown. A sufficient number of via holes should be used to connect the top and bottom ground planes. The evaluation circuit board shown is available from Hittite upon request.

# Mouser Electronics

Authorized Distributor

Click to View Pricing, Inventory, Delivery & Lifecycle Information:

[Analog Devices Inc.:](#)

[HMC812LC4](#) [123768-HMC812LC4](#) [HMC812LC4TR](#)