

Analog Devices Welcomes Hittite Microwave Corporation

NO CONTENT ON THE ATTACHED DOCUMENT HAS CHANGED



THIS PAGE INTENTIONALLY LEFT BLANK

Typical Applications

The HMC720LP3E is ideal for:

- 16 G Fiber Channel
- RF ATE Applications
- Broadband Test & Measurement
- Serial Data Transmission up to 14 Gbps
- Clock Buffering up to 14 GHz

Features

- Inputs Terminated Internally in 50 Ohms
- Differential Inputs are DC Coupled
- Propagation Delay: 120 ps
- Fast Rise and Fall Times: 19 / 18 ps
- Programmable Differential Output Voltage Swing: 600 - 1100 mVp-p
- Power Dissipation: 300 mW
- Single Supply: -3.3 V
- 16 Lead 3x3 mm SMT Package: 9 mm²

Functional Diagram

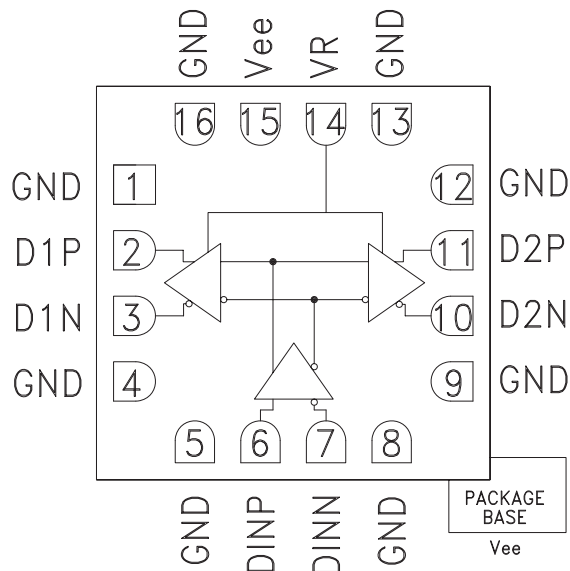

General Description

The HMC720LP3E is a 1:2 Fanout Buffer designed to support data transmission rates up to 14 Gbps, and clock frequencies as high as 14 GHz.

All differential inputs to the HMC720LP3E are CML and terminated on-chip with 50 Ohms to the positive supply, GND, and may be DC or AC coupled. Outputs can be connected directly to a 50 Ohm ground-terminated system or drive devices with CML logic input. The HMC720LP3E also features an output level control pin, VR, which allows for loss compensation or signal level optimization. The HMC720LP3E operates from a single -3.3 V supply and is available in ROHS-compliant 3x3 mm SMT package.

Electrical Specifications, T_A = +25 °C, V_{ee} = -3.3 V, VR = 0 V

Parameter	Conditions	Min.	Typ.	Max	Units
Power Supply Voltage		-3.6	-3.3	-3.0	V
Power Supply Current			90		mA
Maximum Data Rate			14		Gbps
Maximum Clock Rate			14		GHz
Input Voltage Range		-1.5		0.5	V
Input Differential Range		0.1		2.0	Vp-p
Input Return Loss	Frequency <13 GHz		10		dB
Output Amplitude	Single-Ended, peak-to-peak		550		mVp-p
	Differential, peak-to-peak		1100		mVp-p
Output High Voltage			-10		mV
Output Low Voltage			-560		mV
Output Rise / Fall Time	Single-Ended, 20% - 80%		19 / 18		ps



14 Gbps, FAST RISE TIME 1:2 FANOUT BUFFER w/ PROGRAMMABLE OUTPUT VOLTAGE

Electrical Specifications (continued)

Parameter	Conditions	Min.	Typ.	Max	Units
Output Return Loss	Frequency <13 GHz		10		dB
Small Signal Gain			27		dB
Random Jitter J_R	rms			0.2	ps rms
Deterministic Jitter, J_D	$\delta - \delta$, 2^{15} -1 PRBS input [1]		2	6	ps
Propagation Delay, t_d			120		ps
D1 to D2 Data Skew, t_{SKEW}			0		ps
VR Pin Current	VR = 0.0 V		2		mA
VR Pin Current	VR = +0.4 V			3.5	mA

[1] Deterministic jitter measured at 13 GHz with a 300 mVp-p, 2^{15} -1 PRBS input sequence.

DC Current vs. Supply Voltage [1][2]

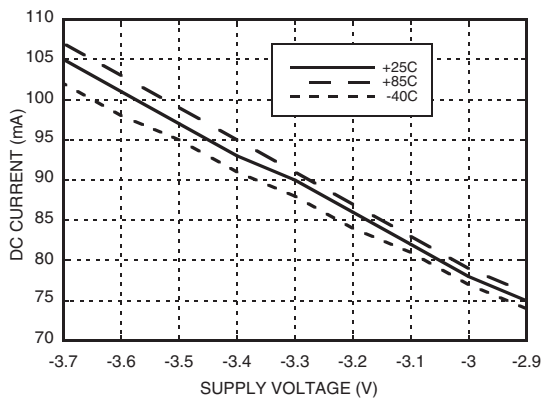

Output Differential Voltage vs. Supply Voltage [1][3]

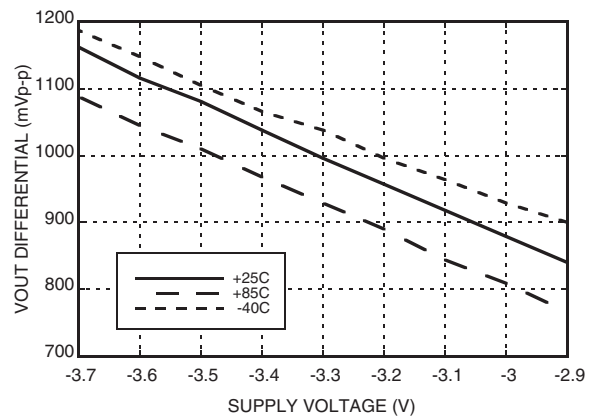

Output Differential Voltage vs. VR [3][4]

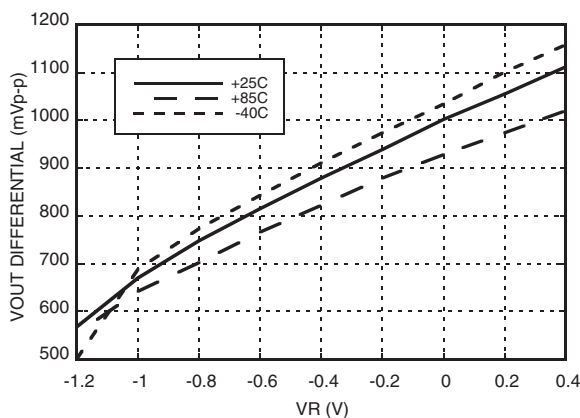

Output Differential Voltage vs. Frequency [1][4]

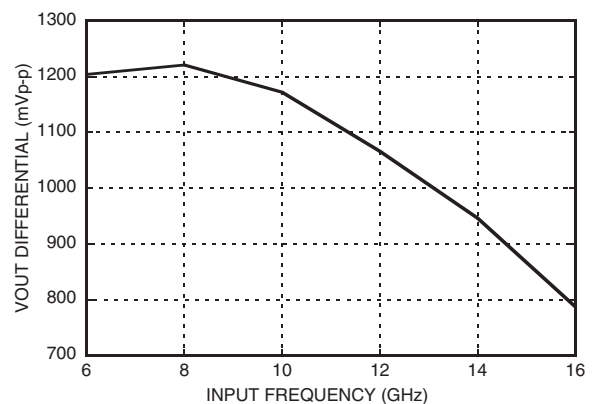

[1] VR = 0.0 V

[2] Frequency = 13 GHz

[3] Frequency = 10 GHz

[4] Vee = -3.3 V



**14 Gbps, FAST RISE TIME 1:2 FANOUT BUFFER
w/ PROGRAMMABLE OUTPUT VOLTAGE**

Rise / Fall Time vs. Supply Voltage [1][2]

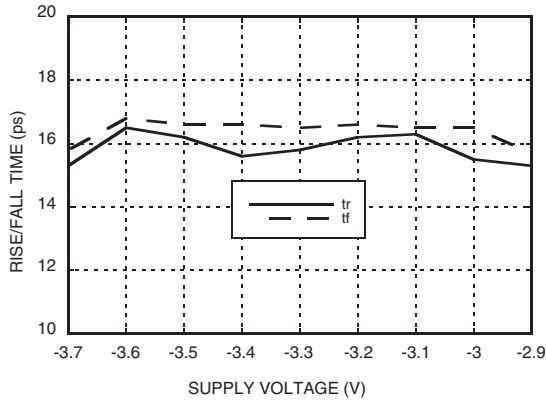

Rise / Fall Time vs. VR [2][3]

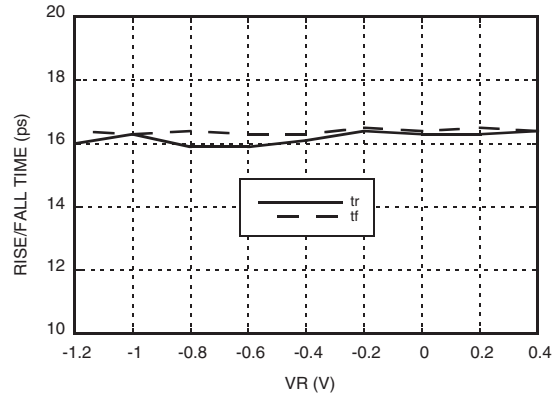

Input Return Loss vs. Frequency

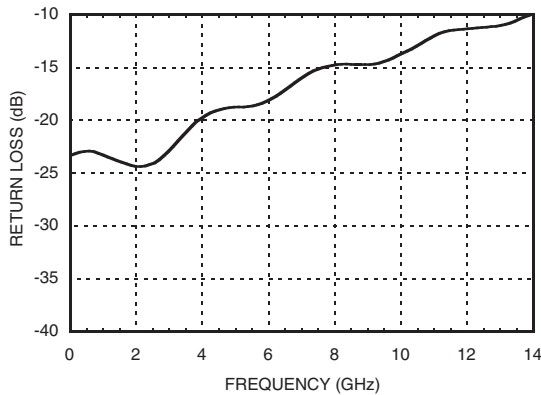

Output Return Loss vs. Frequency

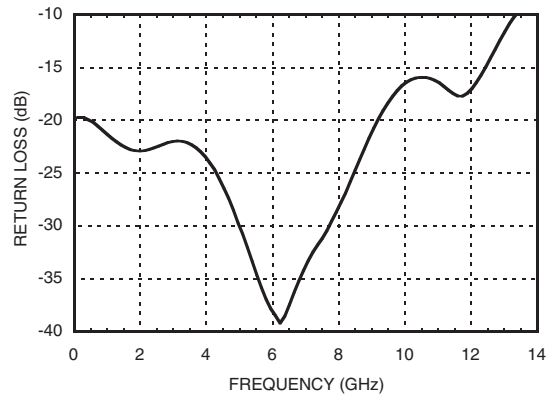

[1] VR = 0.0 V

[2] Frequency = 13 GHz

[3] Vee = -3.3 V



14 Gbps, FAST RISE TIME 1:2 FANOUT BUFFER w/ PROGRAMMABLE OUTPUT VOLTAGE

Eye Diagram

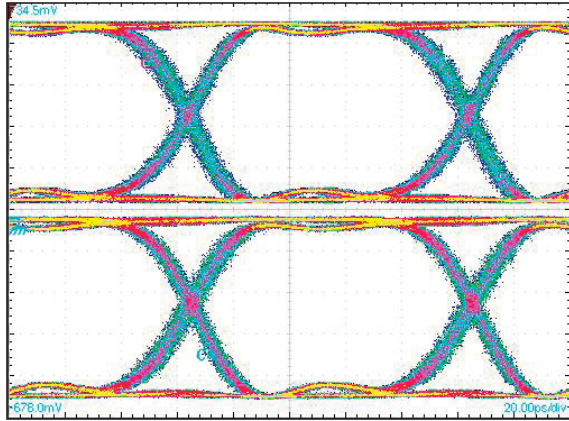

[1] Test Conditions:
 Pattern generated with an Agilent N4903A Serial BERT.
 Eye Diagram presented on a Tektronix CSA 8000.
 Device input = 10 Gbps PN code, $V_{in} = 300$ mVp-p differential.
 Both output channels shown.

Timing Diagram

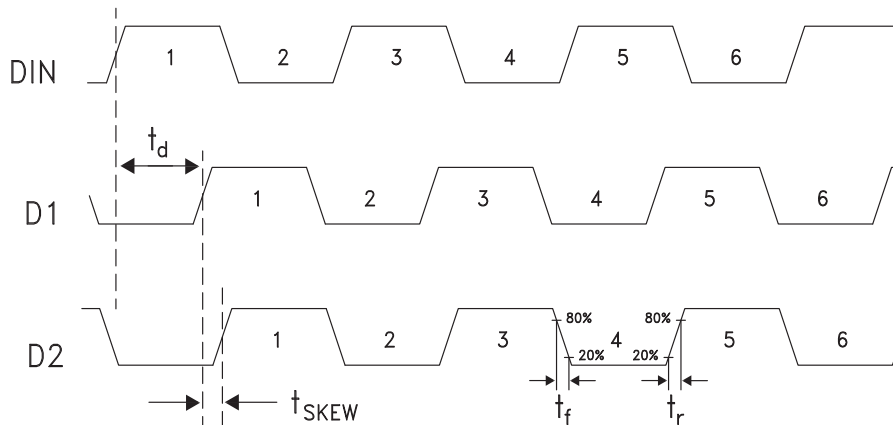

Truth Table

Input	Outputs	
DIN	D1	D2
L	L	L
H	H	H

Notes:
 DIN = DINP - DINN
 D1 = D1P - D1N
 D2 = D2P - D2N

H - Positive differential voltage
 L - Negative differential voltage



14 Gbps, FAST RISE TIME 1:2 FANOUT BUFFER w/ PROGRAMMABLE OUTPUT VOLTAGE

Absolute Maximum Ratings

Power Supply Voltage (Vee)	-3.75 V to +0.5 V
Input Signals	-2 V to +0.5 V
Output Signals	-1.5 V to +1 V
Junction Temperature	125 °C
Continuous Pdiss (T = 85 °C) (derate 20.4 mW/°C above 85 °C)	0.816 W
Thermal Resistance (Rthj-p) Worst case junction to package paddle	49 °C/W
Storage Temperature	-65 °C to +150 °C
Operating Temperature	-40 °C to +85 °C
ESD Sensitivity (HBM)	Class 1C



ELECTROSTATIC SENSITIVE DEVICE
OBSERVE HANDLING PRECAUTIONS

Outline Drawing

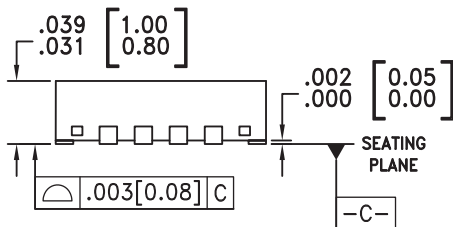
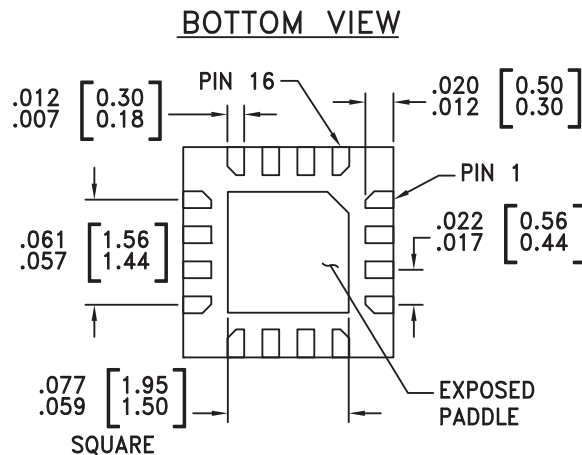
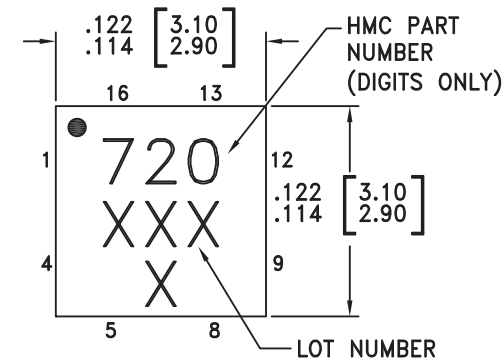

NOTES:

- LEADFRAME MATERIAL: COPPER ALLOY
- DIMENSIONS ARE IN INCHES [MILLIMETERS]
- LEAD SPACING TOLERANCE IS NON-CUMULATIVE
- PAD BURR LENGTH SHALL BE 0.15 mm MAXIMUM.
PAD BURR HEIGHT SHALL BE 0.05 mm MAXIMUM.
- PACKAGE WARP SHALL NOT EXCEED 0.05 mm.
- ALL GROUND LEADS MUST BE SOLDERED TO PCB RF GROUND.
- REFER TO HITTITE APPLICATION NOTE FOR SUGGESTED LAND PATTERN.
- PADDLE MUST BE SOLDERED TO Vee.

Package Information



Part Number	Package Body Material	Lead Finish	MSL Rating	Package Marking ^[3]
HMC720LP3E	RoHS-compliant Low Stress Injection Molded Plastic	100% matte Sn	MSL1 ^[2]	720 XXXX

[1] Max peak reflow temperature of 235 °C
 [2] Max peak reflow temperature of 260 °C
 [3] 4-Digit lot number XXXX

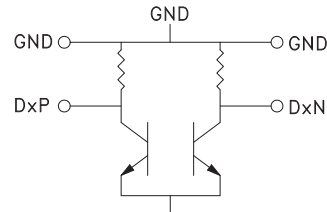
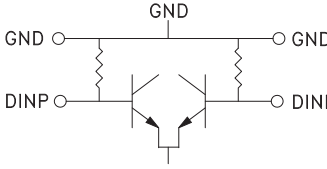

**14 Gbps, FAST RISE TIME 1:2 FANOUT BUFFER
w/ PROGRAMMABLE OUTPUT VOLTAGE**

Pin Descriptions

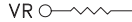
Pin Number	Function	Description	Interface Schematic
1, 4, 5, 8, 9, 12	GND	Signal Grounds	
2, 3 10, 11	D1P, D1N D2N, D2P	Differential Clock / Data Outputs: Current Mode Logic (CML) referenced to positive supply.	
6, 7	DINP, DINN	Differential Clock / Data Inputs: Current Mode Logic (CML) referenced to positive supply	
13, 16	GND	Supply Ground	
14	VR	Output level control. Output level may be adjusted by either applying a voltage to VR per "Output Differential vs. VR" plot.	
15, Package Base	Vee	Negative Supply	



14 Gbps, FAST RISE TIME 1:2 FANOUT BUFFER w/ PROGRAMMABLE OUTPUT VOLTAGE

Evaluation PCB

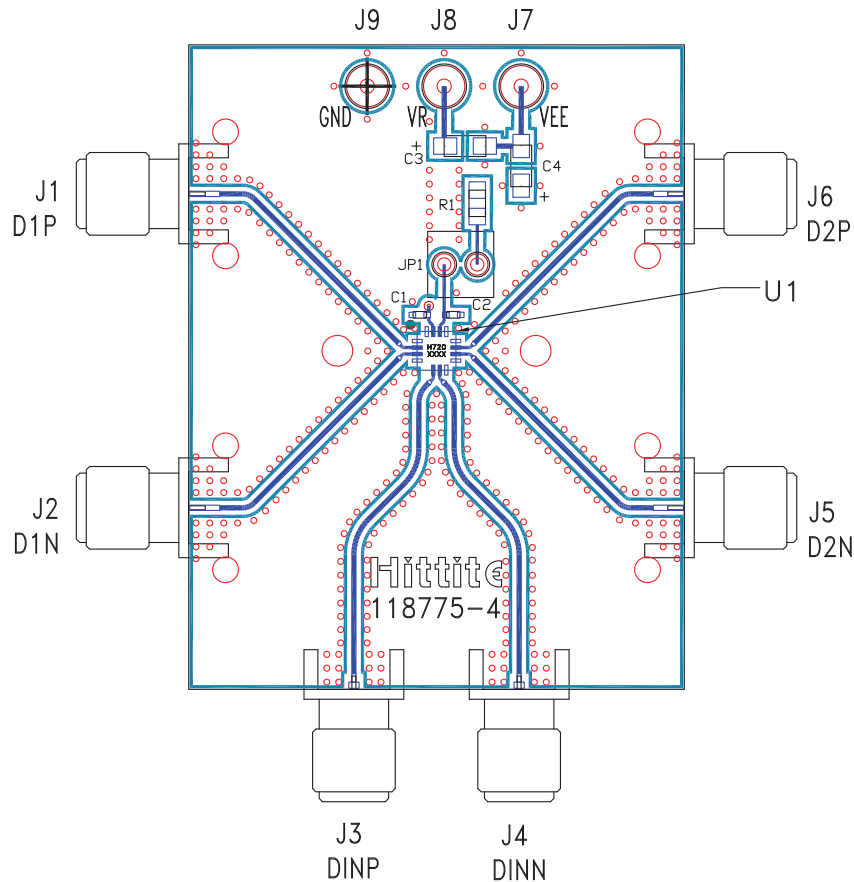

List of Materials for Evaluation PCB 118777 [1]

Item	Description
J1 - J6	PCB Mount SMA RF Connectors
J7 - J9	DC Pin
JP1	0.1" Header with Shorting Jumper
C1, C2	100 pF, Capacitor, 0402 Pkg
C3, C4	4.7 μF Capacitor, Tantalum
R1	10 Ohm Resistor, 0603 Pkg.
U1	HMC720LP3E High Speed Logic, Fanout Buffer
PCB [2]	118775 Evaluation Board

[1] Reference this number when ordering complete evaluation PCB

[2] Circuit Board Material: Arlon 25FR or Rogers 4350

The circuit board used in the application should use RF circuit design techniques. Signal lines should have 50 Ohm impedance while the package ground leads should be connected directly to the ground plane similar to that shown. The exposed packaged base should be connected to Vee. A sufficient number of via holes should be used to connect the top and bottom ground planes. The evaluation circuit board shown is available from Hittite upon request. Install jumper on JP1 to short VR to GND for normal operation.



14 Gbps, FAST RISE TIME 1:2 FANOUT BUFFER w/ PROGRAMMABLE OUTPUT VOLTAGE

Application Circuit

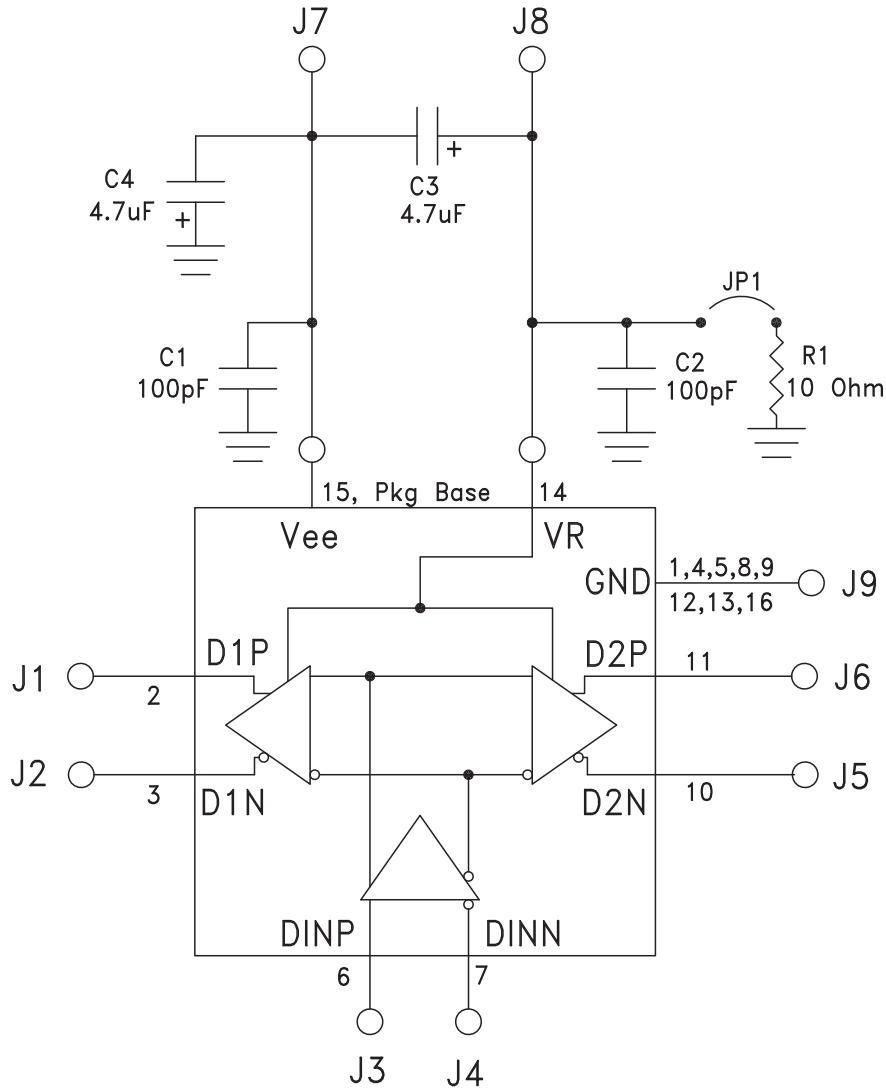

Mouser Electronics

Authorized Distributor

Click to View Pricing, Inventory, Delivery & Lifecycle Information:

[Analog Devices Inc.:](#)

[118777-HMC720LP3E](#)