

Analog Devices Welcomes Hittite Microwave Corporation

NO CONTENT ON THE ATTACHED DOCUMENT HAS CHANGED



THIS PAGE INTENTIONALLY LEFT BLANK

Typical Applications

The HMC678LC3C is ideal for:

- 2:1 Multiplexer up to 13 Gbps
- RF ATE Applications
- Broadband Test & Measurement
- Serial Data Transmission up to 13 Gbps
- Redundant Path Switching
- Built-in Test

Features

- Supports High Data Rates: up to 13 Gbps
- Single-ended inputs
- Differential & Single-ended outputs
- Fast Rise and Fall Times: 19 / 18 ps
- Low Power Consumption: 250 mW typ.
- Programmable Differential Output Voltage Swing: 600 - 1200 mV
- Propagation Delay: 125 ps
- Single Supply: -3.3V
- 16 Lead Ceramic 3x3mm SMT Package: 9mm²

Functional Diagram

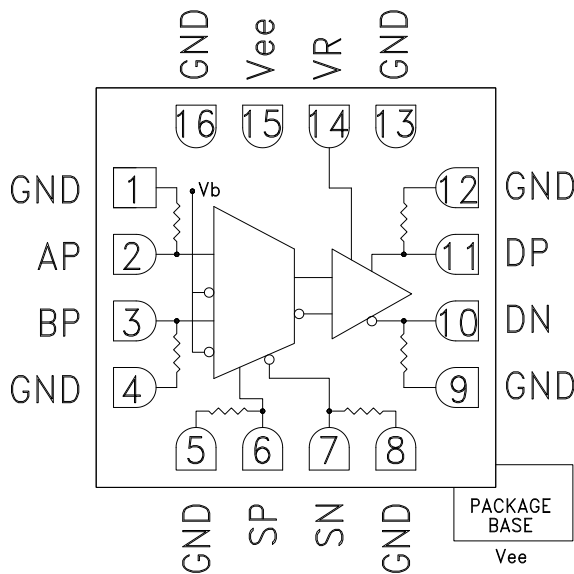

General Description

The HMC678LC3C is a 2:1 Selector designed to support data transmission rates of up to 13 Gbps, and selector port operation of up to 13 GHz. The selector routes one of the two single-ended inputs to the differential output upon assertion of the proper select port. The HMC678LC3C also features an output level control pin, VR, which allows for loss compensation or for signal level optimization.

All single-ended input signals to the HMC678LC3C are terminated with 50 Ohms to ground on-chip, and may be either AC or DC coupled. The outputs of the HMC678LC3C may be operated either differentially or single-ended. Outputs can be connected directly to a 50 Ohm terminated system, while DC blocking capacitors may be used if the terminating system is 50 Ohms to a non-ground DC voltage. The HMC678LC3C operates from a single -3.3V DC supply and is available in a ceramic RoHS compliant 3x3 mm SMT package.

Electrical Specifications, $T_A = +25^\circ\text{C}$, $V_{ee} = -3.3\text{V}$

Parameter	Conditions	Min.	Typ.	Max	Units
Power Supply Voltage		-3.6	-3.3	-3.0	V
Power Supply Current			76		mA
Maximum Data Rate			13		Gbps
Maximum Select Rate			13		GHz
Maximum Serial Transmission Rate			26		Gbps
Input High Voltage		-0.2		0.5	V
Input Low Voltage		-1.5		-0.4	V
Input Return Loss	Frequency <13 GHz		10		dB
Output Amplitude	Single-Ended, peak-to-peak		550		mVp-p
	Differential, peak-to-peak		1100		mVp-p
Output High Voltage			-10		mV



13 Gbps, 2:1 SELECTOR w/ PROGRAMMABLE OUTPUT VOLTAGE

Electrical Specifications (continued)

Parameter	Conditions	Min.	Typ.	Max	Units
Output Low Voltage			-570		mV
Output Rise / Fall Time	Differential, 20% - 80%		19 / 18		ps
Output Return Loss	Frequency <13 GHz		10		dB
Random Jitter, Jr	rms ^[1]			0.2	ps rms
Deterministic Jitter, Jd	peak-to-peak, 2 ¹⁵ -1 PRBS input ^[2]		2		ps, p-p
Propagation Delay, A or B to D _{OUT} , td			125		ps
Propagation Delay Select to Data, tds			135		ps
Set Up & Hold Time, t _{SH}			6		ps

[1] Upper limit of random jitter, Jr, determined by measuring and integrating output phase noise with a sinusoidal input at 5, 10, and 13.5 GHz over temperature

[2] Deterministic jitter calculated by simultaneously measuring the jitter of a 200 mV, 12.5 GHz, 2¹⁵-1 PRBS input, and a single-ended output

DC Current vs. Supply Voltage [1] [2]

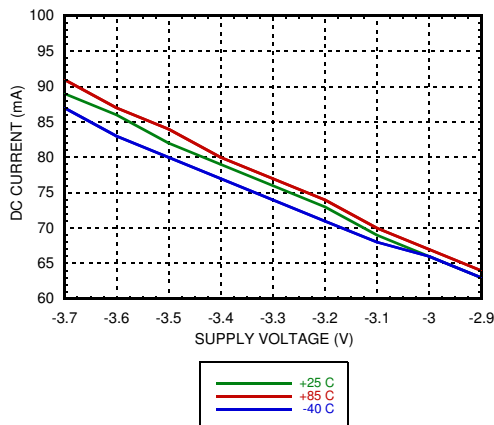

Output Differential vs. Supply Voltage [1] [2]

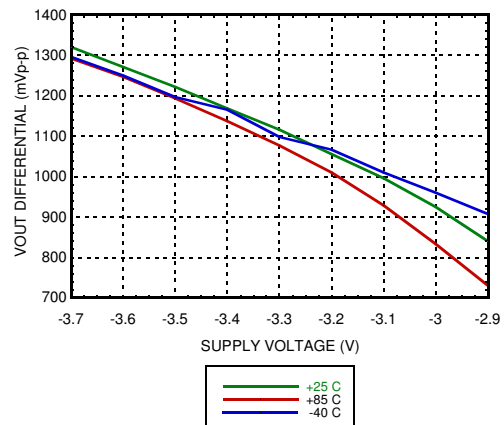

Rise / Fall Time vs. Supply Voltage [1] [2]

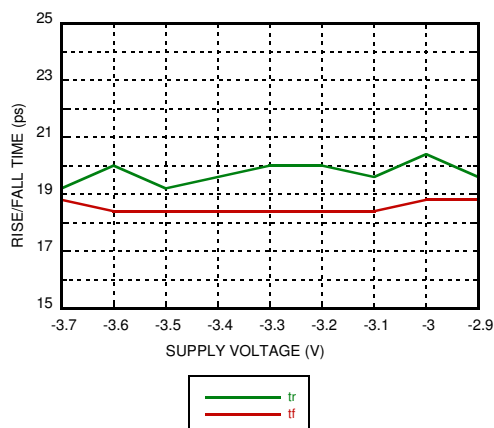

Output Differential vs. Frequency

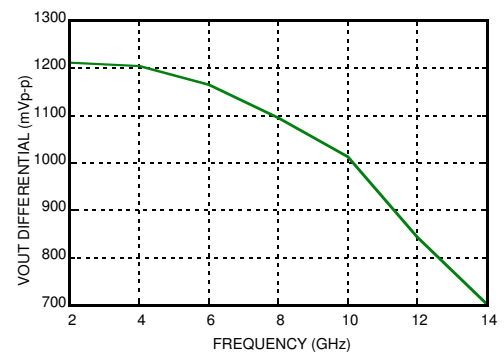

[1] VR = 0.0V

[2] Frequency = 13 GHz



13 Gbps, 2:1 SELECTOR w/ PROGRAMMABLE OUTPUT VOLTAGE

HIGH SPEED DIGITAL LOGIC - SMT

Output Differential vs. VR [2]

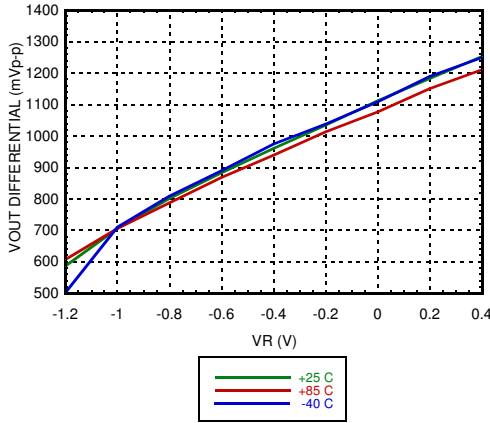

Rise / Fall Time vs. VR [2]

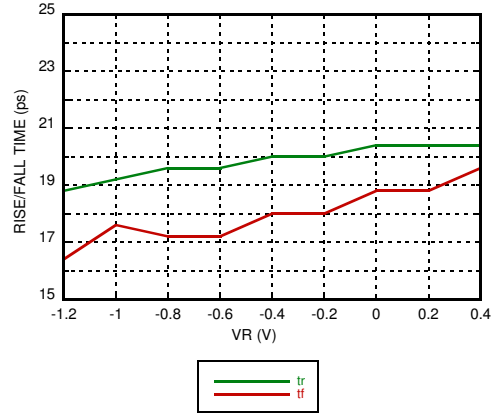

Return Loss vs. Frequency

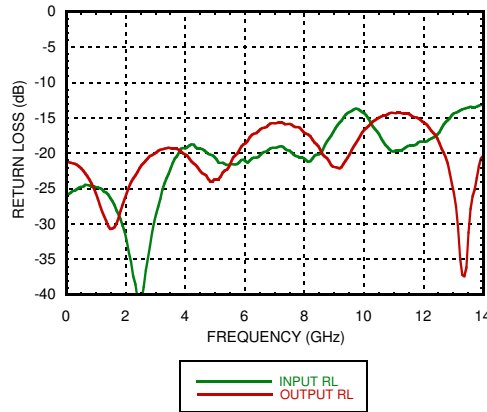

[1] VR = 0.0V

[2] Frequency = 13 GHz



**13 Gbps, 2:1 SELECTOR
w/ PROGRAMMABLE OUTPUT VOLTAGE**

Eye Diagram

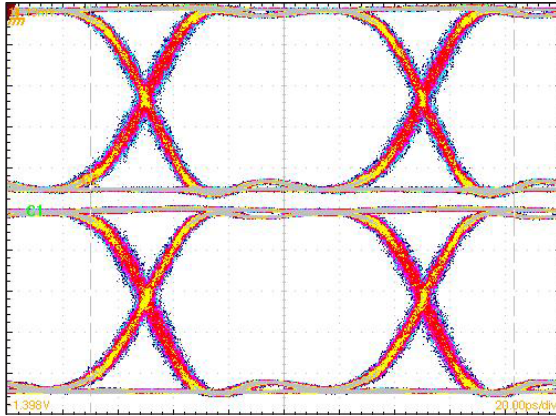

[1] Test Conditions:
Waveform generated with an Agilent N4903A J-Bert.
Rate = 10 GHz
Eye Diagram data presented on a Tektronix CSA 8000

Timing Diagram

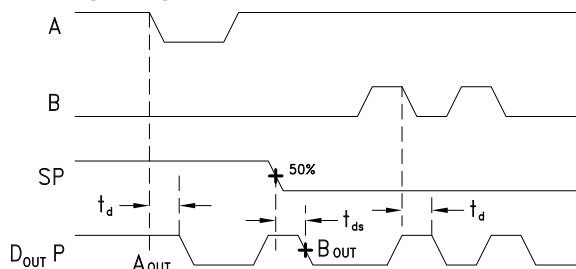

t_d = propagation delay, A or B to Dout
 t_{ds} = propagation delay, Select to Dout

Truth Table

Inputs		Outputs
SP	SN	DP
L	H	A -> D
H	L	B -> D

H = Positive voltage level
L = Negative voltage level

Notes:
D = DP - DN
S = SP - SN

**13 Gbps, 2:1 SELECTOR
w/ PROGRAMMABLE OUTPUT VOLTAGE**
Absolute Maximum Ratings

Power Supply Voltage (Vee)	-3.75V to +0.5V
Input Signals	-2V to +0.5V
Output Signals	-1.5V to +1V
Storage Temperature	-65°C to +150°C
Operating Temperature	-40°C to +85°C
ESD Sensitivity (HBM)	Class 1C

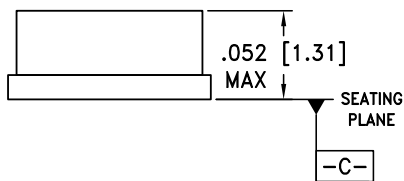
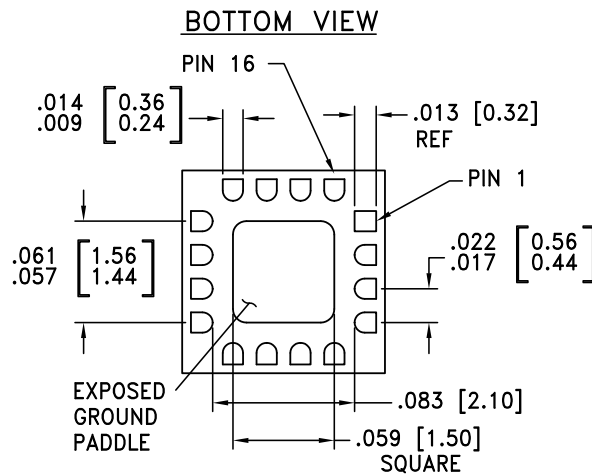
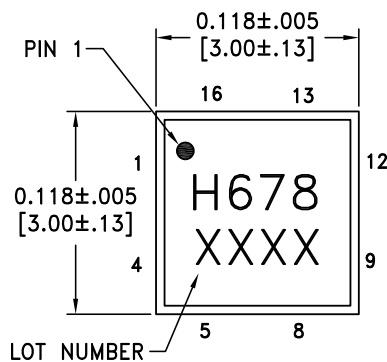
**ELECTROSTATIC SENSITIVE DEVICE
OBSERVE HANDLING PRECAUTIONS**
Outline Drawing

NOTES:

1. PACKAGE BODY MATERIAL: ALUMINA
2. LEAD AND GROUND PADDLE PLATING:
30-80 MICROINCHES GOLD OVER 50 MICROINCHES MINIMUM NICKEL.
3. DIMENSIONS ARE IN INCHES [MILLIMETERS].
4. LEAD SPACING TOLERANCE IS NON-CUMULATIVE.
5. PACKAGE WARP SHALL NOT EXCEED 0.05mm DATUM -C-
6. ALL GROUND LEADS MUST BE SOLDERED TO PCB RF GROUND.
7. GROUND PADDLE MUST BE SOLDERED TO Vee.



Package Information

Part Number	Package Body Material	Lead Finish	MSL Rating	Package Marking ^[2]
HMC678LC3C	Alumina, White	Gold over Nickel	MSL3 ^[1]	H678 XXXX

[1] Max peak reflow temperature of 260 °C

[2] 4-Digit lot number XXXX

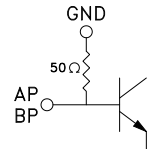
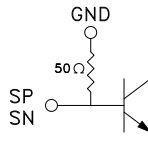
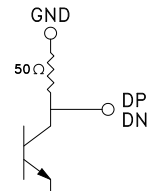

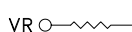
Pin Descriptions

Pin Number	Function	Description	Interface Schematic
1, 4, 5, 8, 9, 12	GND	Signal Grounds	
2, 3	AP, BP	Data Inputs	
6, 7	SP, SN	Select Inputs	
10, 11	DN, DP	Data Outputs	
13, 16	GND	Supply Ground	
14	VR	Output level control. Output level may be adjusted by either applying a voltage to VR per "Output Differential vs. VR" plot, or by tying VR to GND with a resistor per the following equation: $V_o(R) = 1.2 / (2.1 + R)$, R in k Ω	
15, Package Base	Vee	Negative Supply	

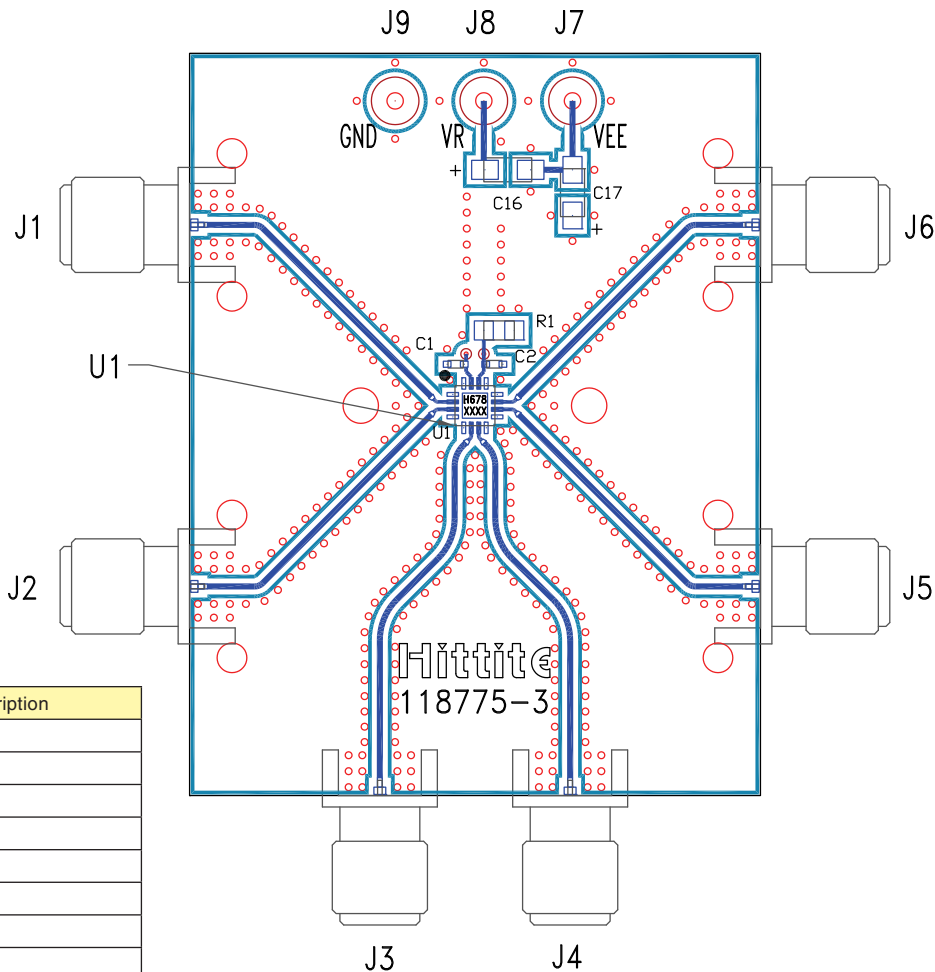

13 Gbps, 2:1 SELECTOR w/ PROGRAMMABLE OUTPUT VOLTAGE

Evaluation PCB



Item	Description
J1	AP
J2	BP
J3	SP
J4	SN
J5	DN
J6	DP
J7	Vee
J8	VR
J9	GND

List of Materials for Evaluation PCB 118777 [1]

Item	Description
J1 - J6	PCB Mount SMA RF Connectors
J7 - J9	DC Pin
C1 - C2	100 pF Capacitor, 0402 Pkg.
C16 - C17	4.7 μ F Capacitor, Tantalum
R1	10 Ohm Resistor, 0603 Pkg.
U1	HMC678LC3C High Speed Logic, 2:1 Selector
PCB [2]	118775 Evaluation Board

[1] Reference this number when ordering complete evaluation PCB

[2] Circuit Board Material: Rogers 4350

The circuit board used in the application should use RF circuit design techniques. Signal lines should have 50 Ohm impedance while the package ground leads should be connected directly to the ground plane similar to that shown. The exposed package base should be connected to Vee. A sufficient number of via holes should be used to connect the top and bottom ground planes. The evaluation circuit board shown is available from Hittite upon request.

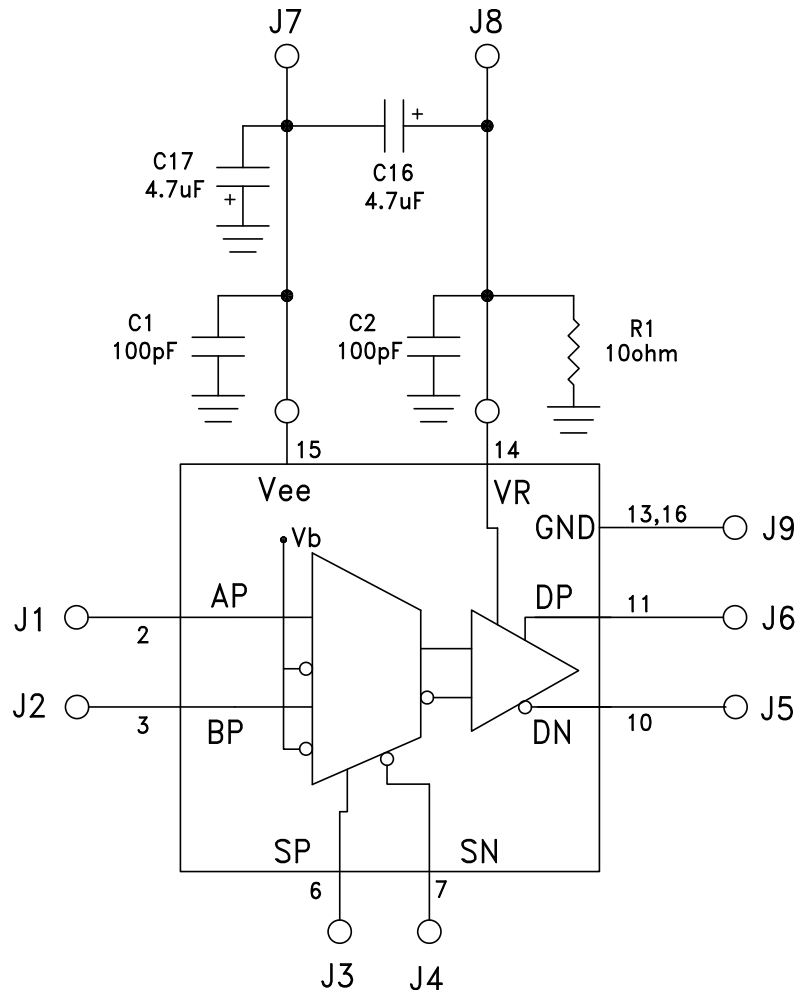
Application Circuit

Mouser Electronics

Authorized Distributor

Click to View Pricing, Inventory, Delivery & Lifecycle Information:

[Analog Devices Inc.:](#)

[118777-HMC678LC3C](#)