

FEATURES

Low noise: 2.4 nV/ $\sqrt{\text{Hz}}$ input referred voltage noise at maximum gain setting
Wide input signal bandwidth: 500 kHz at 1.2 MSPS sample rate, 16-bit resolution
Additional sample rates supported: 300 kSPS, 450 kSPS, 600 kSPS, 900 kSPS, and 1.8 MSPS
4 differential simultaneous sampling channels
No active antialiasing filter required
LNA and PGA with 45 dB gain range in 6 dB steps
Selectable equalizer
Flexible data port supports serial or parallel mode
Supports FSK mode for FMCW radar systems
On-chip 1.5 V reference
Internal oscillator/PLL input: 16 MHz to 54 MHz
High speed serial data interface
SPI control
2 general-purpose inputs/outputs
48-lead LFCSP_SS package
Temperature range: -40°C to $+125^{\circ}\text{C}$
Single supply operation of 3.3 V
Qualified for automotive applications

APPLICATIONS

Automotive LSR systems
Data acquisition systems

GENERAL DESCRIPTION

The [ADAR7251](#) is a 16-bit, 4-channel, simultaneous sampling analog-to-digital converter (ADC) designed especially for applications such as automotive LSR-FMCW or FSK-FMCW radar systems. Each of the four channels contains a low noise amplifier (LNA), a programmable gain amplifier (PGA), an equalizer, a multibit Σ - Δ ADC, and a decimation filter.

The front-end circuitry is designed to allow direct connection to an MMIC output with few external passive components. The [ADAR7251](#) eliminates the need for a high order antialiasing filter, driver op amps, and external bipolar supplies. The [ADAR7251](#) also offers precise channel-to-channel drift matching.

The [ADAR7251](#) features an on-chip phase-locked loop (PLL) that allows a range of clock frequencies for flexibility in the system. The `CONV_START` input and `DATA_READY` output signals synchronize the ADC with an external ramp for applications such as FSK-FMCW radar.

The [ADAR7251](#) supports serial and parallel interfaces at programmable sample rates from 300 kSPS to 1.8 MSPS, as well as easy connections to digital signal processors (DSPs) and microcontroller units (MCUs) in the system.

TABLE OF CONTENTS

Features	1	PLL Control Register	38
Applications	1	PLL Status Register	38
General Description	1	Master Enable Switch Register	39
Revision History	3	ADC Enable Register	39
Functional Block Diagram	4	Power Enable Register	40
Specifications	5	Clear the ASIL errors Register	41
Analog Channel	5	Selects Which Errors to Mask Register	42
Digital Input/Output	6	ASIL Error Flag Register	43
Power Supply	7	ASIL Error Code Register	43
Digital Filter	8	CRC Value, Bits[7:0] Register	44
SPI Port Timing	8	CRC Value Register	44
Serial/Peripheral Parallel Interface (PPI) Port Timing	8	Start Calculating the CRC Value of the Register Map Content Register	45
Absolute Maximum Ratings	11	Register Map CRC Calculation Done Register	45
Thermal Resistance	11	Register Map CRC Value, Bits[7:0] Register	45
ESD Caution	11	Register Map CRC Value, Bits[15:8] Register	46
Pin Configuration and Function Descriptions	12	Low Noise Amplifier Gain Control Register	46
Typical Performance Characteristics	14	Programmable Gain Amplifier Gain Control Register	47
Terminology	17	Signal Path for ADC 1 Through ADC 4 Register	48
Theory of Operation	18	Decimator Rate Control Register	49
Low Speed Ramp Radar Analog Front End	18	High Pass Filter Control Register	50
Main Channel Overview	18	DAQ Mode Control Register	51
Σ - Δ Modulation and Digital Filtering	18	Decimator Truncate Control Register	52
Differential Input Configuration	19	Serial Output Port Control Register	52
Equalizer (EQ)	19	Parallel Port Control Register	53
Using LNA/PGA, EQ, or the Input Capacitor	20	ADC Digital Output Mode Register	54
Reference	20	Auxiliary ADC Read Value Registers	54
Auxiliary ADC	20	Auxiliary ADC Sample Rate Selection Register	55
Power Supply	21	Auxiliary ADC Mode Register	56
LDO	21	MPx Pin Modes Registers	56
Clock Requirements	21	MP Write Value Registers	58
Crystal Oscillator	21	MP Read Value Registers	58
PLL	21	SPI_CLK Pin Drive Strength and Slew Rate Register	59
GPIO	23	SPI_MISO Pin Drive Strength and Slew Rate Register	60
ADC Data Port	23	$\overline{\text{SPI_SS}}$ Pin Drive Strength and Slew Rate Register	60
PCB Layout Guidelines	33	SPI_MOSI Pin Drive Strength and Slew Rate Register	61
Register Summary	34	ADDR15 Pin Drive Strength and Slew Rate Register	62
Register Details	37	FAULT Pin Drive Strength and Slew Rate Register	62
Clock Control Register	37	FS_ADC Pin Drive Strength and Slew Rate Register	63
PLL Denominator Register	37	$\overline{\text{CONV_START}}$ Pin Drive Strength and Slew Rate Register	64
PLL Numerator Register	37		

SCLK_ADC Pin Drive Strength and Slew Rate Register64	CRC Enable/Disable Register70
ADC_DOUTx Pins Drive Strength and Slew Rate Registers65	Typical Application Circuit.....71
DATA_READY Pin Drive Strength and Slew Rate Register.....68	Outline Dimensions.....72
XTAL Enable and Drive Register68	Ordering Guide72
ADC Test Register.....69	Automotive Products.....72
Digital Filter Sync Enable Register70	

REVISION HISTORY

11/14—Revision 0: Initial Version

FUNCTIONAL BLOCK DIAGRAM

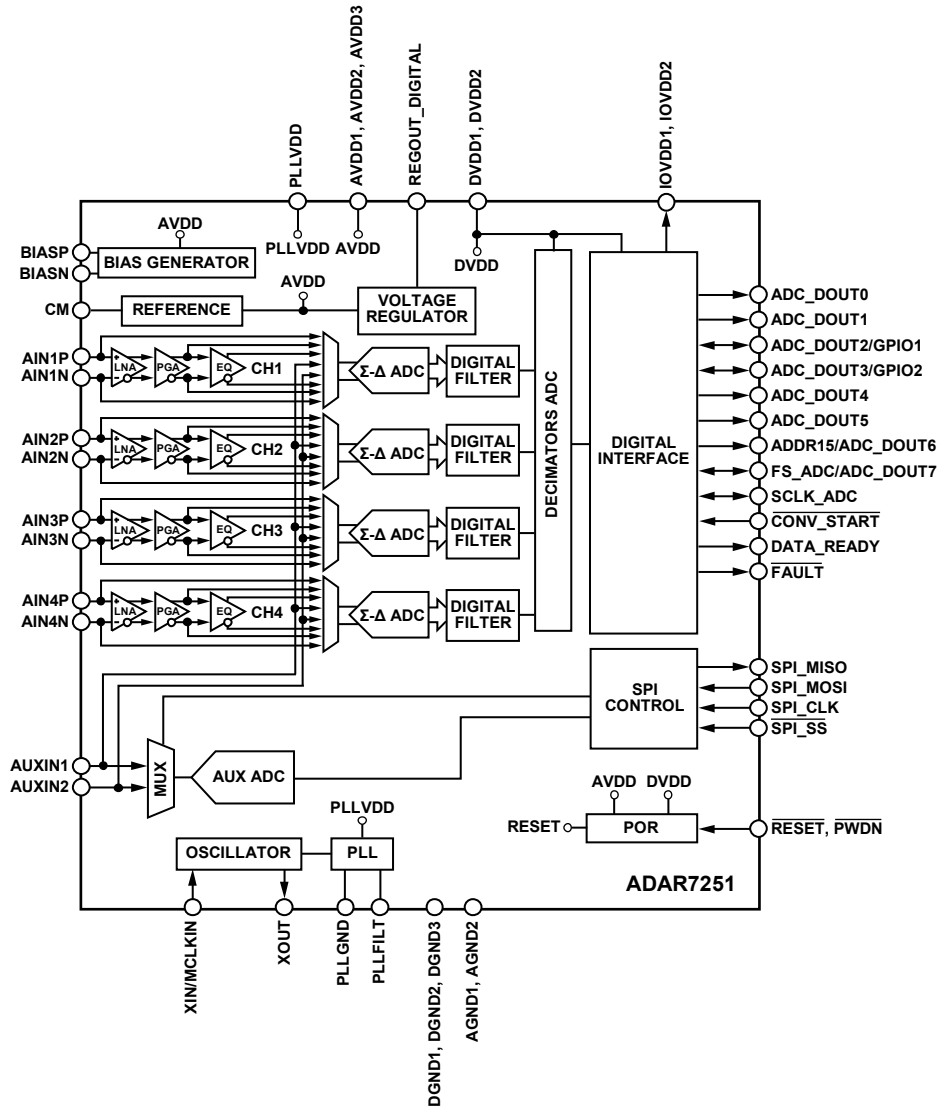

Figure 1.

12357-001

SPECIFICATIONS

ANALOG CHANNEL

AVDD_X = 3.3 V, DVDD_X = 1.8 V, IOVDD_X = 3.3 V, V_{REF} = 1.5 V internal/external reference, f_{SAMPLE} = 1.2 MSPS, T_{AMB} = -40°C to +125°C, unless otherwise noted.

Table 1.

Parameter	Test Conditions/Comments	Min	Typ	Max	Unit	
DYNAMIC PERFORMANCE						
Input Referred Noise Spectral Density Frequency = 100 Hz	Gain = 9 dB		44.7		nV/√Hz	
	Gain = 15 dB		23.6		nV/√Hz	
	Gain = 21 dB		15		nV/√Hz	
	Gain = 27 dB		12		nV/√Hz	
	Gain = 33 dB		11.3		nV/√Hz	
	Gain = 39 dB		10.9		nV/√Hz	
	Gain = 45 dB		10.8		nV/√Hz	
	Frequency = 1 kHz	Gain = 9 dB		16		nV/√Hz
		Gain = 15 dB		8.7		nV/√Hz
		Gain = 21 dB		5.4		nV/√Hz
		Gain = 27 dB		4.3		nV/√Hz
		Gain = 33 dB		4		nV/√Hz
		Gain = 39 dB		3.86		nV/√Hz
		Gain = 45 dB		3.83		nV/√Hz
	Frequency = 100 kHz	Gain = 9 dB		9.7		nV/√Hz
		Gain = 15 dB		5.2		nV/√Hz
		Gain = 21 dB		3.3		nV/√Hz
		Gain = 27 dB		2.67		nV/√Hz
		Gain = 33 dB		2.5		nV/√Hz
		Gain = 39 dB		2.44		nV/√Hz
		Gain = 45 dB		2.4		nV/√Hz
Equalizer Corner Frequency	Setting 1 EQ00		54		kHz	
	Setting 2 EQ01		45		kHz	
	Setting 3 EQ10		37		kHz	
	Setting 4 EQ11		32		kHz	
Signal to Noise Ratio (SNR)	No input signal and reference to 0 dBFS	88	94		dB	
Spurious-Free Dynamic Range (SFDR)	At -3 dBFS input, 100 kHz	68	82		dB	
Total Harmonic Distortion Plus Noise (THD + N)	At -3 dBFS input, 100 kHz		-80	-66	dB	
	At -1 dBFS input, 100 kHz		-77	-62	dB	
Channel to Channel Crosstalk	At 50 kHz, -3 dBFS input		-94	-89	dB	
Interchannel Gain Mismatch		-0.5	0	+0.5	dB	
Interchannel Phase Mismatch			0.04		Degrees	
DC Offset			-72		dBFS	
Power Supply Rejection	Ripple = 100 mV rms on AVDD _X at 1 kHz		65		dB	

Parameter	Test Conditions/Comments	Min	Typ	Max	Unit
ANALOG INPUT					
Full-Scale Differential Voltage	Gain = 0 dB (LNA and PGA bypass)		5.6		V p-p
	Gain = 9 dB		1.987		V p-p
	Gain = 15 dB		0.995		V p-p
	Gain = 21 dB		0.498		V p-p
	Gain = 27 dB		249		mV p-p
	Gain = 33 dB		124		mV p-p
	Gain = 39 dB		62		mV p-p
	Gain = 45 dB		31		mV p-p
Common-Mode Rejection Ratio (CMRR)	At 1 kHz		68		dB
Gain Error		-0.8		+0.8	dB
Input Resistance	Single-ended		2860		Ω
	Differential		5720		Ω
VOLTAGE REFERENCE IN/OUT (V_{REF})	At the CM pin		1.5		V
CONVERSION SAMPLE RATE					
Sample Rate		0.3	1.2	1.8	MSPS
Input Signal Bandwidth		150	600	900	kHz
PLL					
Input Frequency		16		54	MHz
Output Frequency (Internal)			115.2		MHz
Lock Time			1		ms
LDO					
REGOUT_DIGITAL Output Voltage	Used for internal digital core only		1.8		V
Line Regulation	AVDDx as an input	2.97	3.3	3.63	V
Load Regulation	Used for internal digital core only		1		%
AUXILIARY ADC					
Full-Scale Input			3.3		V p-p
Sample Rate		112.5		450	kHz
Resolution			8		bits
INL			0.5		LSB
DNL			1		LSB
Input Resistance ¹	Switched capacitor input at a switching frequency of 112.5 kHz		1.2		M Ω

¹ From simulation.

DIGITAL INPUT/OUTPUT

DVDDx = 1.8 V, IOVDDx = 3.3 V, C_{LOAD} = 22 pF.

Table 2.

Parameter	Symbol	Test Conditions/Comments	Min	Typ	Max	Unit
INPUT VOLTAGE						
High Level	V_{IH}		0.7 × IOVDDx			V
Low Level	V_{IL}				0.3 × IOVDDx	V
OUTPUT VOLTAGE						
High Level	V_{OH}	$I_{OH} = 1 \text{ mA}$	IOVDDx - 0.60			V
Low Level	V_{OL}	$I_{OL} = 1 \text{ mA}$			0.4	V
INPUT CAPACITANCE						
					5	pF
INPUT LEAKAGE CURRENT						
					±10	μA

POWER SUPPLY

AVDDx = 3.3 V, DVDDx = 1.8 V, IOVDDx = 3.3 V, $f_s = 1.2$ MHz (master mode), PLL enabled with 19.2 MHz master clock input, -3 dBFS, 100 kHz input on all channels, unless otherwise noted.

Table 3.

Parameter	Test Conditions/Comments	Min	Typ	Max	Unit
DVDD	On-chip LDO	1.62	1.8	1.98	V
Current					
Normal Operation	DVDDx external at $f_s = 1.2$ MHz		32		mA
Power-Down	Standby without master clock		80		μ A
AVDD		2.97	3.3	3.6	V
Current					
Normal Operation	4-channel ADC, DVDDx internal, $f_s = 1.2$ MHz		115		mA
	Power save mode		87		mA
Power-Down	<u>RESET/PWDN</u> pin held low without master clock		1.1		mA
	<u>RESET/PWDN</u> pin held low with master clock		1.1		mA
IOVDD		2.97	3.3	3.6	V
Current					
Normal Operation	Input master clock = 19.2 MHz				
	4-channel ADC; serial mode, 2 channels per data line				
	$f_s = 1.2$ MHz		4		mA
	$f_s = 900$ kHz		3.4		mA
	$f_s = 600$ kHz		2.7		mA
	$f_s = 300$ kHz		2		mA
	4-channel ADC; parallel mode, byte wide format				
	$f_s = 1.8$ MHz		2.8		mA
	$f_s = 1.2$ MHz		2.3		mA
	$f_s = 900$ kHz		2		mA
	$f_s = 600$ kHz		1.7		mA
	$f_s = 300$ kHz		1.3		mA
Power-Down	<u>RESET/PWDN</u> pin held low without master clock		335		μ A
	<u>RESET/PWDN</u> pin held low with master clock		360		μ A
POWER DISSIPATION					
Normal Operation	Input master clock = 19.2 MHz				
	DVDDx internal, 4-channel ADC at $f_s = 1.2$ MHz		400		mW
	DVDDx external, 4-channel ADC at $f_s = 1.2$ MHz		294		mW
Power-Down, All Supplies	<u>RESET/PWDN</u> pin held low with master clock		5		mW

DIGITAL FILTER

Table 4.

Parameter	Mode	Factor	Min	Typ	Max	Unit
ADC DECIMATION FILTER	At $f_s = 1.2$ MHz, decimation ratio = 48					
At $f_s = 1.2$ MHz, Decimation Ratio = 48						
Pass Band	–0.1 dB corner	$0.166 \times f_s$		200		kHz
Pass-Band Droop	At 600 kHz			–1.4		dB
Stop Band		$0.666 \times f_s$		800		kHz
Stop-Band Attenuation				70		dB
Group Delay				95		μ s
High-Pass Filter						
Corner Frequency	–3 dB, programmable in eight steps		0.729		93.3	Hz
Attenuation	See Figure 24 in the Typical Performance Characteristics section					

SPI PORT TIMING

DVDDX = 1.8 V, IOVDDX = 3.3 V, $C_{LOAD} = 22$ pF, $I_{OUT} = \pm 1$ mA.

Table 5.

Parameter	Description	Min	Limit at		Unit
			Typ	Max	
SPI PORT	See Figure 2				
t_{CCPH}	SPI_SCLK high	50			ns
t_{CCPL}	SPI_SCLK low	50			ns
f_{SPI_CLK}	SPI_SCLK frequency			10	MHz
t_{CDS}	SPI_MOSI setup to SPI_SCLK rising	10			ns
t_{CDH}	SPI_MOSI hold from SPI_SCLK rising	10			ns
t_{CLS}	SPI_SS setup to SPI_SCLK rising	10			ns
t_{CLH}	SPI_SS hold from SPI_SCLK rising	40			ns
t_{CLPH}	SPI_SS high	10			ns
t_{CDH}	SPI_MISO hold from SPI_SCLK rising			30	ns
t_{COD}	SPI_MISO delay from SPI_SCLK falling			30	ns
t_{COTS}	SPI_MISO tristate from SPI_SS rising			30	ns

SERIAL/PERIPHERAL PARALLEL INTERFACE (PPI) PORT TIMING

DVDDX = 1.8 V, IOVDDX = 3.3 V, $C_{LOAD} = 22$ pF, $I_{OUT} = \pm 1$ mA.

Table 6.

Parameter	Description	Min	Limit at		Unit
			Typ	Max	
INPUT MASTER CLOCK (MCLKIN)					
Duty Cycle	MCLKIN duty cycle; MCLKIN at $256 \times f_s$, $384 \times f_s$, $512 \times f_s$, and $768 \times f_s$	40		60	%
f_{MCLKIN}	MCLKIN frequency, PLL in MCLK mode	16		54	MHz
RESET					
Reset Pulse, t_{RESET}	RESET/PWDN held low	15			ns
PLL					
Lock Time				1	ms

Parameter	Description	Limit at			Unit
		Min	Typ	Max	
ADC SERIAL PORT MASTER MODE	See Figure 3				
t_{SCKH}	SCLK_ADC high, slave mode	10			ns
t_{SCKL}	SCLK_ADC low, slave mode	10			ns
t_{DS}	ADC_DOUTx setup to SCLK_ADC rising, slave mode	10			ns
t_{DH}	ADC_DOUTx hold from SCLK_ADC rising, slave mode	5			ns
t_{DD}	ADC_DOUTx delay from SCLK_ADC falling			18	ns
t_{FSH}	FS_ADC hold from SCLK_ADC rising			18	ns
t_{FSS}	FS_ADC setup from SCLK_ADC falling			1	ns
ADC SERIAL PORT SLAVE MODE	See Figure 4				
t_{SCKH}	SCLK_ADC high, slave mode	7			ns
t_{SCKL}	SCLK_ADC low, slave mode	7			ns
t_{DS}	ADC_DOUTx valid to SCLK_ADC rising, slave mode	11			ns
t_{DH}	ADC_DOUTx hold from SCLK_ADC rising, slave mode	11			ns
t_{DD}	ADC_DOUTx delay from SCLK_ADC falling			2	ns
t_{FSH}	FS_ADC hold from SCLK_ADC rising			1	ns
t_{FSS}	FS_ADC setup from SCLK_ADC falling			1	ns
PARALLEL MODE, BYTE WIDE FORMAT	See Figure 5; if using CONV_START, see Figure 6 for the CONV_START to DATA_READY timing relation				
t_{SCKH}	SCLK_ADC high, master mode	28			ns
t_{SCKL}	SCLK_ADC low, master mode	28			ns
t_{DS}	ADC_DOUTx setup to SCLK_ADC rising, master mode	7			ns
t_{DH}	ADC_DOUTx hold from SCLK_ADC rising, master mode	5			ns
t_{DD}	ADC_DOUTx delay from SCLK_ADC falling for left justified (LJ) mode For I ² S mode, add one SCLK_ADC period to the t_{DD} of LJ mode			6	ns
t_{CSDR}	CONV_START falling to DATA_READY rising			1.215	μ s
DATA ACQUISITION (DAQ) MODE	CONV_START falling to DATA_READY rising, see Figure 6				
t_{DRH}	CONV_START rising to DATA_READY falling			0.44	μ s
t_{CSDR}	DAQ16 mode (16 acquisition clock cycles) DAQ24 mode (24 acquisition clock cycles) DAQ32 mode (32 acquisition clock cycles)			1.215 1.8 2.43	μ s

Timing Diagrams

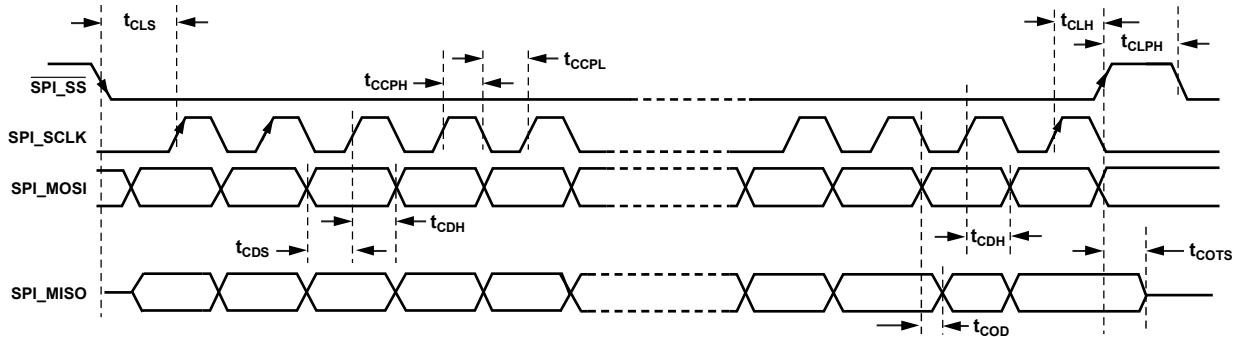

Figure 2. SPI Port Timing

12367-002

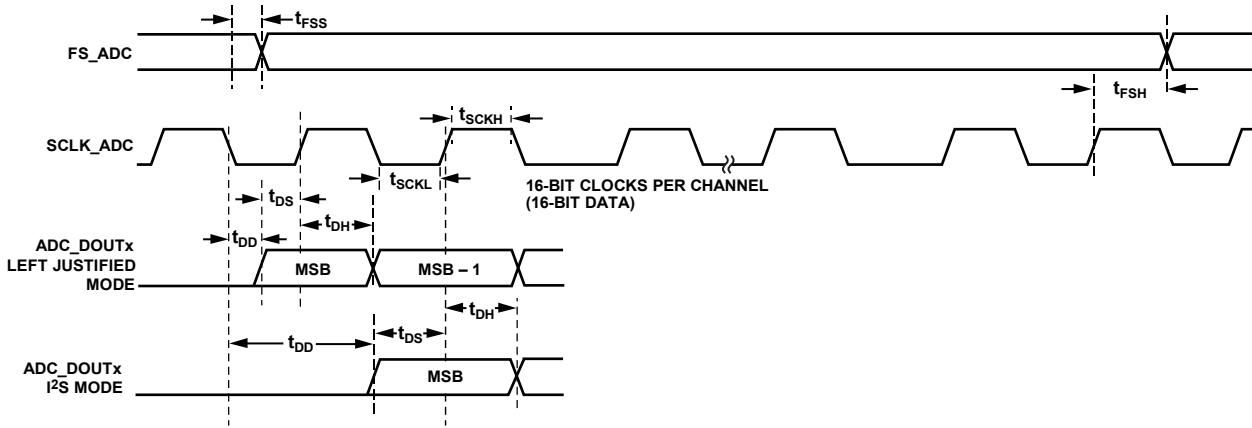

Figure 3. Serial Port Timing Master Mode

12357-004

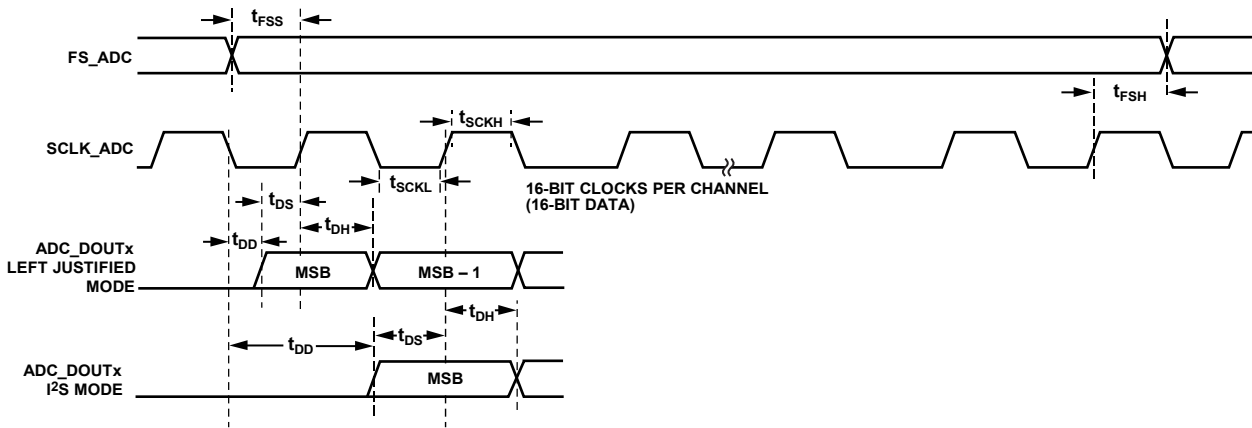

Figure 4. Serial Output Port Timing Slave Mode

12357-003

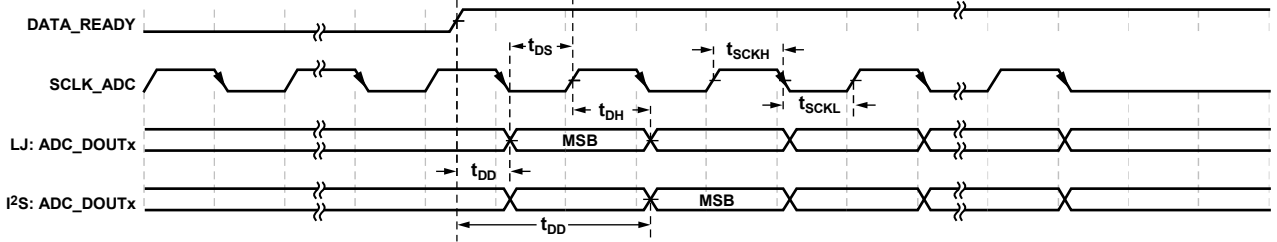

Figure 5. PPI Timing Master Mode

12357-005

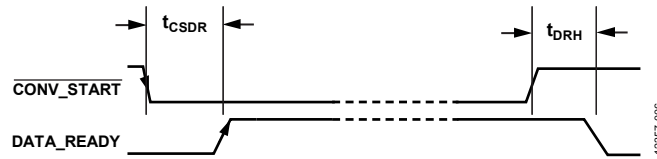

Figure 6. CONV_START to DATA_READY Timing

12357-006

ABSOLUTE MAXIMUM RATINGS

Table 7.

Parameter	Rating
AVDDx to AGNDx, DGNDx	−0.3 V to +3.63 V
DVDDx to AGNDx, DGNDx	−0.3 V to +1.98 V
IOVDDx to AGNDx, DGNDx	−0.3 V to +3.63 V
AGNDx to DGNDx	−0.3 V to +0.3 V
Analog Input Voltage to AGNDx	−0.3 V to +3.63 V
Digital Input Voltage to DGNDx	−0.3 V to +3.63 V
Digital Output Voltage to DGNDx	−0.3 V to +3.63 V
Input Current to Any Pin Except Supplies	±10 mA
Operating Temperature Range (Ambient)	−40°C to +125°C
Junction Temperature Range	−40°C to +150°C
Storage Temperature Range	−65°C to +150°C
RoHS-Compliant Temperature Soldering Reflow	260°C

Stresses at or above those listed under Absolute Maximum Ratings may cause permanent damage to the product. This is a stress rating only; functional operation of the product at these or any other conditions above those indicated in the operational section of this specification is not implied. Operation beyond the maximum operating conditions for extended periods may affect product reliability.

THERMAL RESISTANCE

θ_{JA} represents junction-to-ambient thermal resistance, and θ_{JC} represents the junction-to-case thermal resistance. All characteristics are for a standard JEDEC board per JESD51.

Table 8. Thermal Resistance

Package Type	θ_{JA} ¹	θ_{JC} ¹	Unit
48-Lead LFCSP_SS	25	1	°C/W

¹JEDEC 2S2P standard board.

ESD CAUTION



ESD (electrostatic discharge) sensitive device.

Charged devices and circuit boards can discharge without detection. Although this product features patented or proprietary protection circuitry, damage may occur on devices subjected to high energy ESD. Therefore, proper ESD precautions should be taken to avoid performance degradation or loss of functionality.

PIN CONFIGURATION AND FUNCTION DESCRIPTIONS

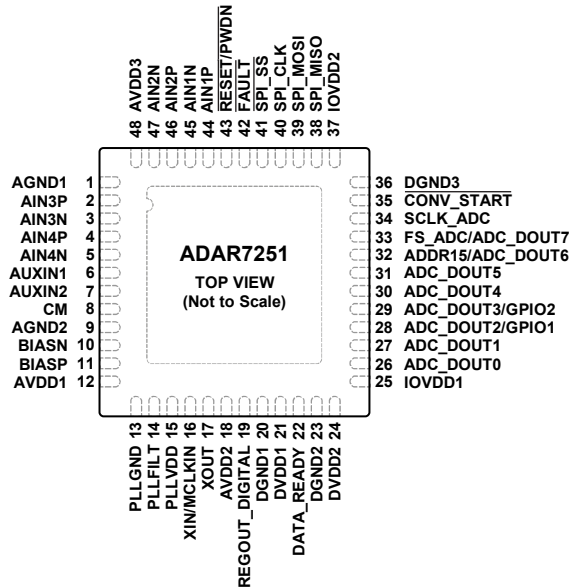

- NOTES
 1. THE EXPOSED PAD ON THE BOTTOM OF THE PACKAGE MUST BE SOLDERED TO THE GROUND PLANE ON THE BOARD FOR POWER DISSIPATION.

Figure 7. Pin Configuration

Table 9. Pin Function Descriptions

Pin No.	Mnemonic	Type ¹	Description
	EPAD		Exposed Pad. The exposed pad on the bottom of the package must be soldered to the ground plane on the board for power dissipation.
1	AGND1 ²	PWR	Analog Ground. This pin is the ground reference point for all analog blocks in the ADAR7251 .
2	AIN3P	AIN	Noninverting Input to Differential Analog Channel 3.
3	AIN3N	AIN	Inverting Input to Differential Analog Channel 3.
4	AIN4P	AIN	Noninverting Input to Differential Analog Channel 4.
5	AIN4N	AIN	Inverting Input to Differential Analog Channel 4.
6	AUXIN1	AIN	Auxiliary ADC Analog Input 1. Single-ended analog input channel.
7	AUXIN2	AIN	Auxiliary ADC Analog Input 2. Single-ended analog input channel.
8	CM	AIO	ADC Reference Output. Connect a 10 μF capacitor in parallel with a 100 nF capacitor from this pin to AGNDx.
9	AGND2 ²	PWR	Analog Ground. This pin is the ground reference point for all analog blocks in the ADAR7251 .
10	BIASN	AOUT	Internal Bias Generator. Decouple to AGNDx using a 0.47 μF capacitor.
11	BIASP	AOUT	Internal Bias Generator. Decouple to AVDDx using a 0.47 μF capacitor.
12	AVDD1	PWR	Analog Supply Voltage, 3.3 V. Decouple this supply pin to AGNDx. See Figure 60.
13	PLLGND	PWR	Analog Ground for PLL. Connect to a ground plane directly on the board.
14	PLLFILT	AIN	Filter Components Connection for PLL. See Figure 60.
15	PLLVDD	PWR	Analog Supply for Analog PLL, 3.3 V. Decouple to the PLLGND pin (Pin13) using a 0.1 μF multilayer ceramic capacitor (MLCC). Connect to AVDDx or an external 3.3 V source. It is recommended to add the filter for a clean 3.3 V source and for good PLL performance.
16	XIN/MCLKIN	AIN	Internal Oscillator Input/Clock Input. If using an external crystal, connect it between the XIN and XOUT pins. If not using a crystal, a single-ended clock must be provided at the MCLKIN pin. The ADAR7251 accepts a clock frequency range of 16 MHz to 54 MHz.
17	XOUT	AOUT	Internal Oscillator Output Connection for External Crystal.
18	AVDD2	PWR	Analog Supply Voltage, 3.3 V. Decouple this supply pin to AGNDx. See Figure 60.
19	REGOUT_DIGITAL	PWR	LDO Regulator Output for Internal Digital Core (1.8 V, Typical). Decouple to DGNDx. See Figure 60. Connect REGOUT_DIGITAL to the DVDDx pins if using the internal regulator to supply the 1.8 V to the digital core.
20	DGND1 ³	PWR	Digital Ground. This pin is the ground reference point for the digital circuitry on the ADAR7251 .

Pin No.	Mnemonic	Type ¹	Description
21	DVDD1	PWR	Digital Core Power Supply Input. Connect decoupling capacitors between the DVDDx and DGNDx pins. See Figure 60. The voltage on this pin is 1.8 V. This pin can be connected to REGOUT_DIGITAL (Pin 19), or to the external 1.8 V source if the internal LDO is not used.
22	DATA_READY	DOUT	ADC Conversion Data Ready Output. Connect to the DSP general-purpose input/output (GPIO) in the system.
23	DGND2 ³	PWR	Digital Ground. This pin is the ground reference point for digital circuitry on the ADAR7251 .
24	DVDD2	PWR	Digital Core Power Supply Input. Connect decoupling capacitors between the DVDDx and DGNDx pins. See Figure 60. The voltage on this pin is 1.8 V. This pin can be connected to REGOUT_DIGITAL (Pin 19), or to the external 1.8 V source if the internal LDO is not used.
25	IOVDD1	PWR	Logic Power Supply Input. The voltage supplied at this pin determines at what voltage the interface operates. Connect decoupling capacitors between the IOVDDx and DGNDx pins. See Figure 60.
26	ADC_DOUT0	DOUT	ADC Data Output (Serial Mode) or ADC Data Output Bit 0 and Bit 8 (PPI Mode). Refer to the ADC Serial Mode and ADC PPI (Byte Wide Mode) sections for function information.
27	ADC_DOUT1	DOUT	ADC Data Output (Serial Mode) or ADC Data Output Bit 1/9 (PPI Mode). Refer to the ADC Serial Mode and ADC PPI (Byte Wide Mode) sections for function information.
28	ADC_DOUT2/GPIO1	DOUT	ADC Data Output Bit 2 and Bit 10 (PPI Mode)/General-Purpose Input/Output 1. Refer to the ADC Serial Mode section for function information.
29	ADC_DOUT3/GPIO2	DOUT	ADC Data Output Bit 3 and Bit 11 (PPI Mode)/General-Purpose Input/Output 2. Refer to the ADC PPI (Byte Wide Mode) section for function information.
30	ADC_DOUT4	DIO	ADC Data Output Bit 4 and Bit 12 (PPI Mode). Refer to the ADC PPI (Byte Wide Mode) section for function information.
31	ADC_DOUT5	DIO	ADC Data Output Bit 5 and Bit 13 (PPI Mode). Refer to the ADC PPI (Byte Wide Mode) section for function information.
32	ADDR15/ ADC_DOUT6	DIO	Device Address Setting for the SPI Control Interface/ADC Data Output Bit 6 and Bit 14 in PPI mode. This pin sets Bit 1 of the SPI device address. Connect to either DGNDx or IOVDDx as desired using a 10 kΩ pull-down or pull-up resistor. Refer to the ADC PPI (Byte Wide Mode) section for function information.
33	FS_ADC/ ADC_DOUT7	DIO	Active Low Frame Synchronization Signal for Default ADC Data (Serial Mode)/ADC Data Output Bit 7 and Bit 15 (PPI Mode). Refer to the ADC PPI (Byte Wide Mode) section for function information.
34	SCLK_ADC	DIO	Serial Bit Clock for the ADC Data Output (Serial Mode and PPI Mode). This pin is an input in slave mode or is an output in master mode.
35	CONV_START	DIN	ADC Conversion Start in DAQ/PPI/Serial Mode (Active Low). An active low signal initiates an ADC conversion. See the Theory of Operation section for further details.
36	DGND3 ³	PWR	Digital Ground. This pin is the ground reference point for digital circuitry on the ADAR7251 .
37	IOVDD2	PWR	Logic Power Supply Input. The voltage supplied at this pin determines at what voltage the interface operates. Connect decoupling capacitors between the IOVDDx and DGNDx pins. See Figure 60.
38	SPI_MISO	DOUT	SPI Control Interface Slave Data Output.
39	SPI_MOSI	DIN	SPI Control Interface Slave Data Input.
40	SPI_CLK	DIN	SPI Control Interface Serial clock Input.
41	SPI_SS	DIN	SPI Control Interface Slave Select (Active Low Input). Connect an external 10 kΩ pull-up resistor to IOVDDx.
42	FAULT	DOUT	Digital Output. This pin becomes active under fault condition. Connect an external 10 kΩ pull-up resistor to IOVDDx. This pin can be used as an interrupt input to the microcontroller or DSP in case of faults.
43	RESET/PWDN	DIN	Active Low Reset Input/Power-Down. The ADAR7251 requires an external reset signal to hold the RESET input low until AVDDx is within the specified operating range. When held low, this pin places the ADAR7251 into power-down mode.
44	AIN1P	AIN	Noninverting Input to Differential Analog Channel 1.
45	AIN1N	AIN	Inverting Input to Differential Analog Channel 1.
46	AIN2P	AIN	Noninverting Input to Differential Analog Channel 2.
47	AIN2N	AIN	Inverting Input to Differential Analog Channel 2.
48	AVDD3	PWR	Analog Supply Voltage. Decouple this supply pin to AGNDx.

¹ PWR is power supply or ground pin, AIN is analog input, AIO is analog input/output, AOUT is analog output, DIN is digital input, DOUT is digital output, and DIO is digital input/output.

² All the AGNDx pins (AGND1 and AGND2) are shorted internally and recommended to be connected to a single ground plane on the board. Refer to the PCB Layout Guidelines section for details.

³ All the DGNDx pins (DGND1, DGND2, and DGND3) are shorted internally and recommended to be connected to a single ground plane on the board. Refer to the PCB Layout Guidelines section for details.

TYPICAL PERFORMANCE CHARACTERISTICS

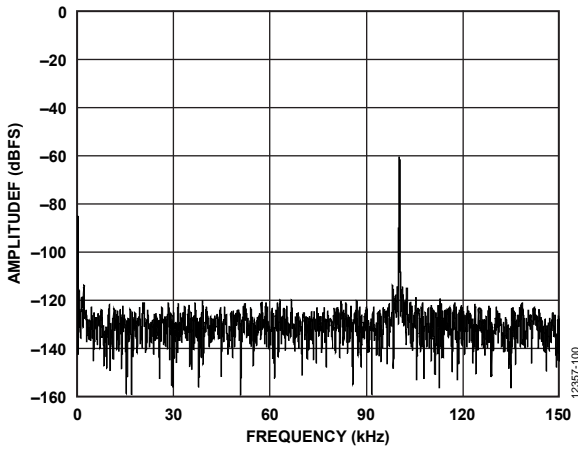

Figure 8. FFT with -60 dBFS, 100 kHz Input at $f_s = 300$ kHz

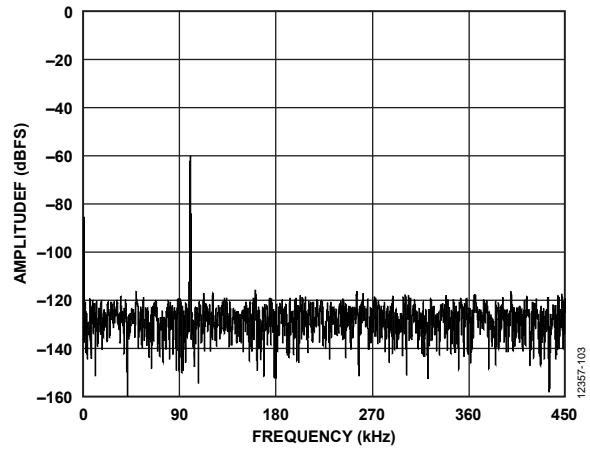

Figure 11. FFT with -60 dBFS, 100 kHz Input at $f_s = 900$ kHz

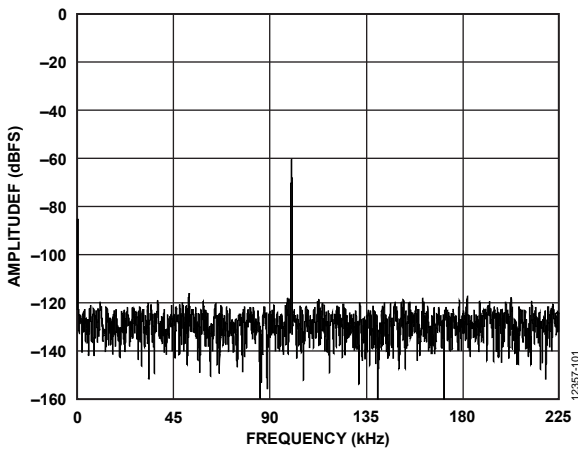

Figure 9. FFT with -60 dBFS, 100 kHz Input at $f_s = 450$ kHz

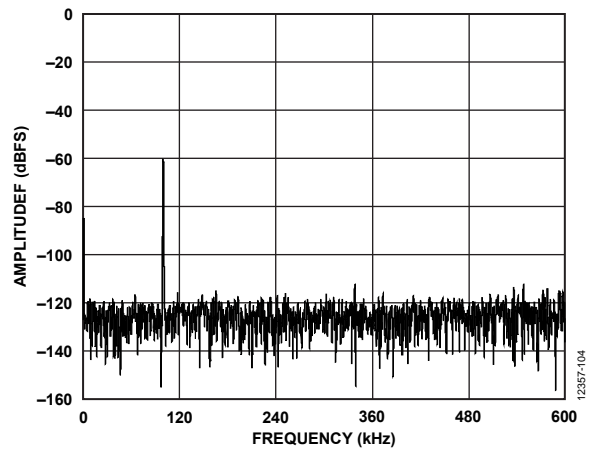

Figure 12. FFT with -60 dBFS, 100 kHz Input at $f_s = 1.2$ MHz

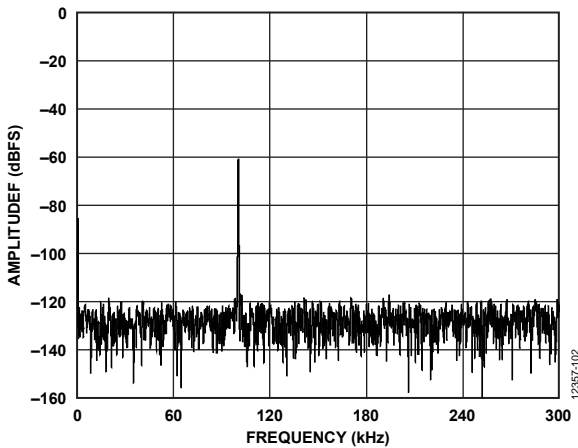

Figure 10. FFT with -60 dBFS, 100 kHz Input at $f_s = 600$ kHz

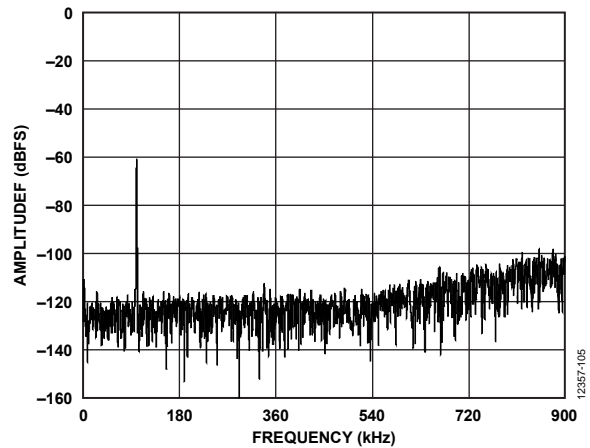

Figure 13. FFT with -60 dBFS, 100 kHz Input at $f_s = 1.8$ MHz

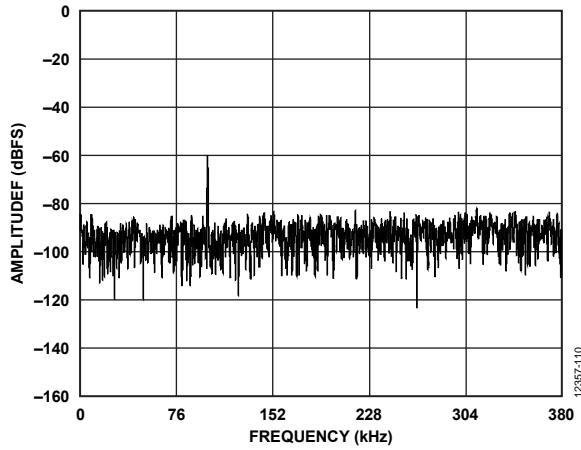

Figure 14. FFT with -60 dBFS, 100 kHz Input, DAQ16, at $f_s = 758$ kHz

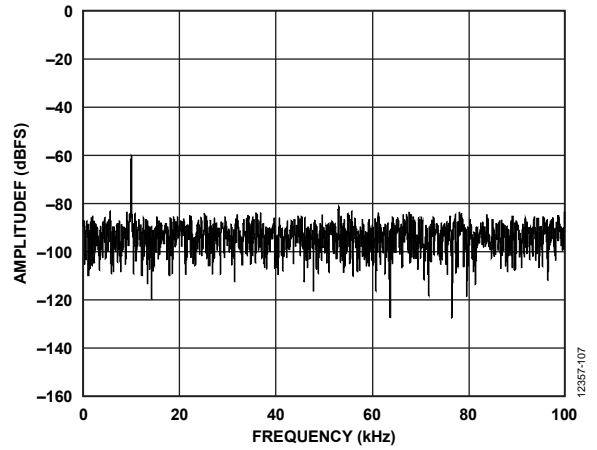

Figure 17. FFT with -60 dBFS, 10 kHz Input, DAQ16, at $f_s = 200$ kHz

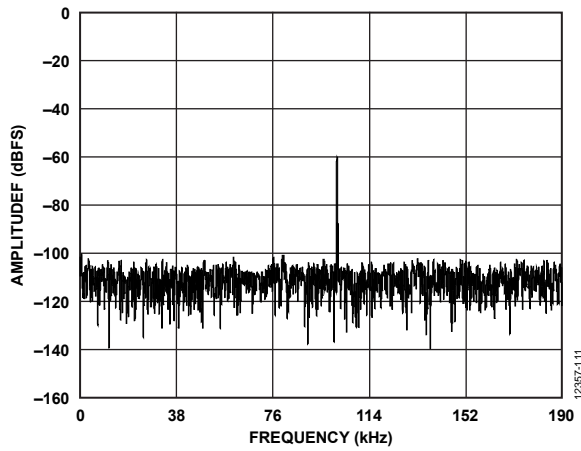

Figure 15. FFT with -60 dBFS, 100 kHz Input, DAQ24, at $f_s = 380$ kHz

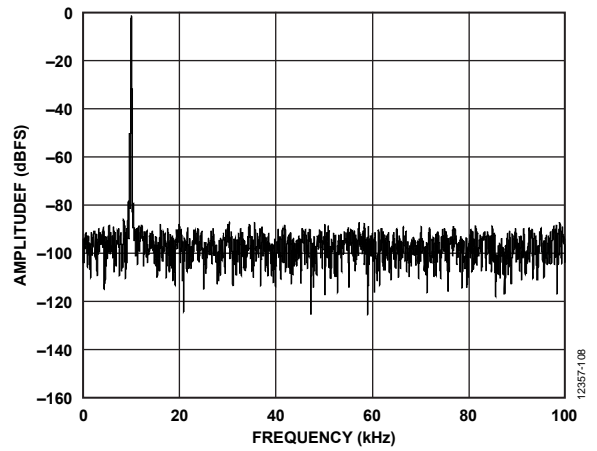

Figure 18. FFT with -1 dBFS, 10 kHz Input, DAQ16, at $f_s = 200$ kHz

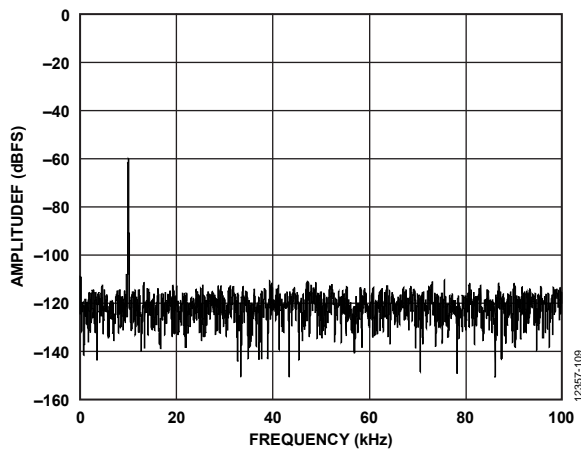

Figure 16. FFT with -60 dBFS, 10 kHz Input, DAQ32, at $f_s = 200$ kHz

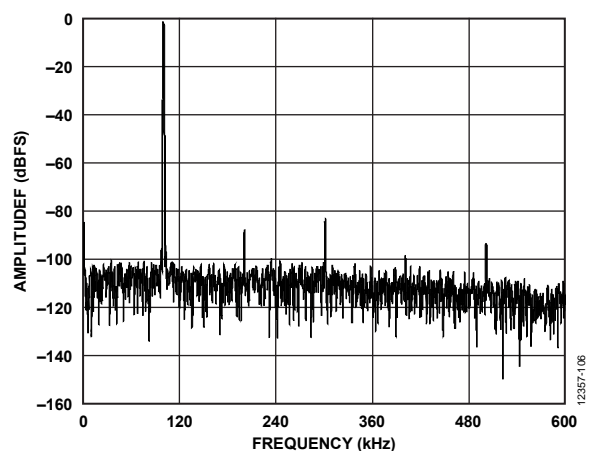

Figure 19. FFT with -1 dBFS, 100 kHz Input, at $f_s = 1.2$ MHz

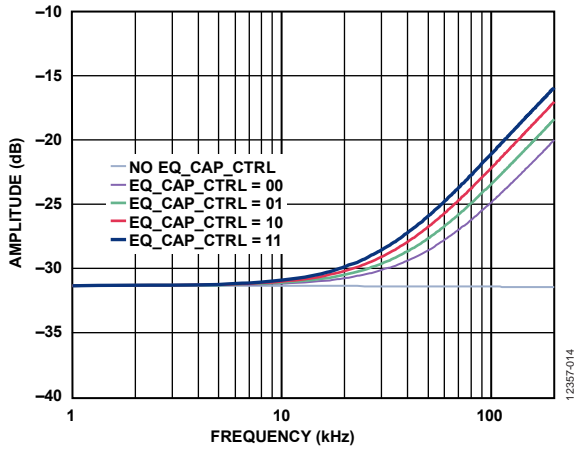

Figure 20. EQ

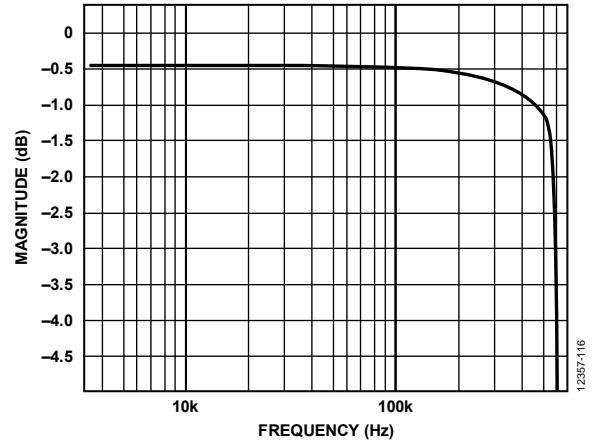

Figure 23. ADC Digital Filter Pass Band at $f_s = 1.2$ MHz

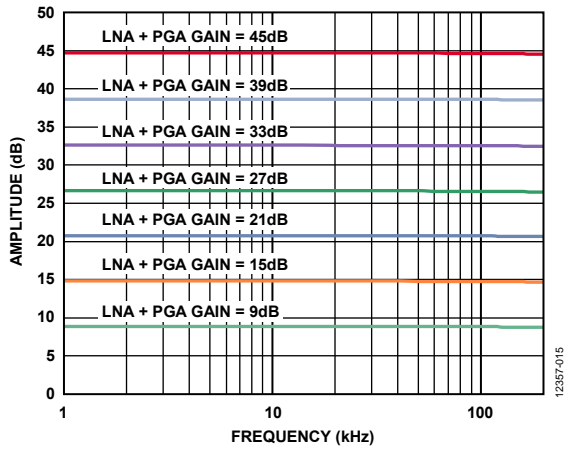

Figure 21. LNA + PGA Gain

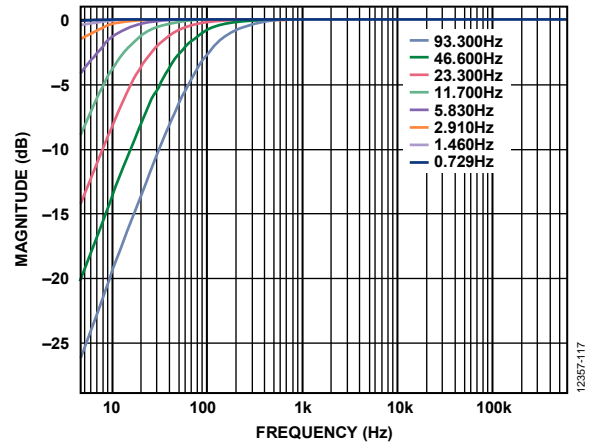

Figure 24. ADC High-Pass Filter Frequency Response

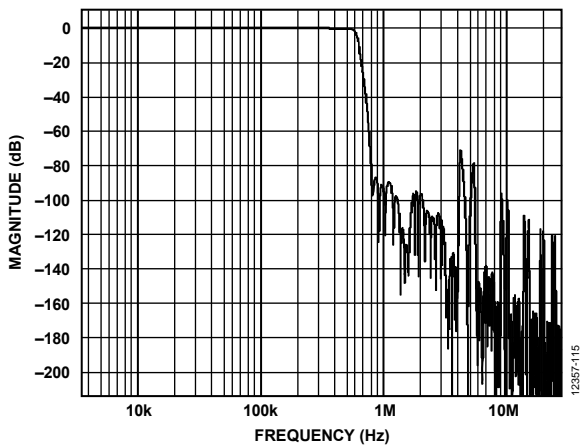

Figure 22. Frequency Response, ADC Digital Filter at $f_s = 1.2$ MHz

TERMINOLOGY

Integral Nonlinearity (INL)

INL is the maximum deviation from a straight line passing through the endpoints of the ADC transfer function. For the [ADAR7251](#), the endpoints of the transfer function are zero scale, a point ½ LSB below the first code transition, and full scale, a point ½ LSB above the last code transition.

Differential Nonlinearity (DNL)

DNL is the difference between the measured and the ideal 1 LSB change between any two adjacent codes in the ADC.

Offset Error

Offset error is the deviation of the first code transition (00...000) to (00...001) from the ideal (such as ground + 0.5 LSB).

Gain Error

For the [ADAR7251](#), gain error is the deviation of the last code transition (111...110) to (111...111) from the ideal (such as $V_{REF} - 1.5$ LSB) after the offset error is adjusted out.

Signal-to-Noise Ratio (SNR)

SNR is the ratio of the rms value of the actual input signal to the rms sum of all other spectral components below the Nyquist frequency, excluding harmonics and dc. The value for SNR is expressed in decibels (dB).

Total Harmonic Distortion (THD)

THD is the ratio of the rms sum of harmonics to the fundamental. For the [ADAR7251](#), THD is defined as

$$THD \text{ (dB)} = 20 \log \frac{\sqrt{V_2^2 + V_3^2 + V_4^2 + V_5^2 + V_6^2}}{V_1}$$

where:

V_1 is the rms amplitude of the fundamental.

$V_2, V_3, V_4, V_5,$ and V_6 are the rms amplitudes of the second through the sixth harmonics.

Dynamic Range (DNR)

THD + N is measured in dB with an input level of –60 dBFS (–60 dB relative to the full-scale input). Then, 60 dB is added to the measured THD + N value and is expressed in decibels. For example, when measuring 36 dB THD + N with a –60 dBFS input, DNR is 60 + 36 = 96 dB.

Peak Harmonic or Spurious Noise

Peak harmonic or spurious noise is defined as the ratio of the rms value of the next largest component in the ADC output spectrum (up to $f_s/2$ and excluding dc) to the rms value of the fundamental. Normally, the value of this specification is determined by the largest harmonic in the spectrum, but for ADCs where the harmonics are buried in the noise floor, it is a noise peak.

THEORY OF OPERATION

LOW SPEED RAMP RADAR ANALOG FRONT END

The most common application for the ADAR7251 is low speed ramp, frequency modulated, continuous wave, or frequency shift keying radar (LSR-FMCW or FSK-FMCW). Figure 28 shows a typical block diagram of an LSR/FSK radar system for a 4-channel application. The signal chain may require up to eight channels, each including an LNA, a PGA, and a Σ - Δ ADC. All input channels on the ADAR7251 sample the input signals simultaneously. The ADAR7251 also delivers secondary features required by an LSR radar system: a 2-channel, auxiliary 8-bit ADC and two GPIOs.

MAIN CHANNEL OVERVIEW

The ADAR7251 features an on-chip, fully differential LNA and PGA to feed the Σ - Δ input pins, as well as a digital filter block to perform the required filtering on the Σ - Δ modulator output. Using this Σ - Δ conversion technique with added digital filtering, the analog input converts to an equivalent digital word. The ADAR7251 uses an internal 1.5 V reference voltage.

Σ - Δ MODULATION AND DIGITAL FILTERING

The input waveform applied to the modulator is sampled, and an equivalent digital word is output to the digital filter at a rate equal to the modulator clock. The modulator is clocked by $48 \times f_s$ (57.6 MHz clock signal, f_{CLK} , for $f_s = 1.2$ MHz). By employing oversampling, the quantization noise spreads across a wide bandwidth (see Figure 25). This means that the noise energy contained in the bandwidth of interest is reduced. To further reduce the quantization noise, a third-order modulator is employed to shape the noise spectrum so that most of the noise energy is shifted out of the signal band (see Figure 26).

The digital filtering that follows the modulator removes the large out-of-band quantization noise (see Figure 27) while also reducing the data rate at the input of the filter to 1.2 MHz or less at the output of the filter, depending on the decimation rate used.

The total channel noise of the ADAR7251 depends on the bandwidth specification and the selected analog input range. The data rate at the output of the ADAR7251 can be reduced further to meet specific application requirements. The continuous time modulator removes the need for a high order antialias filter at the input to the ADAR7251. The continuous time Σ - Δ modulator used within the ADAR7251 has inherent antialiasing due to oversampling. The device uses $48\times$ oversampling. This relaxes the requirement of filtering required at the input of the ADC. Typically, a single pole passive resistor capacitor (RC) filter is sufficient.

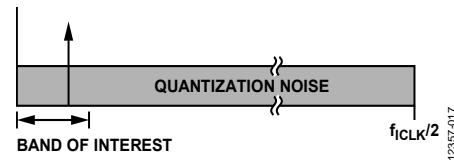

Figure 25. Σ - Δ ADC, Quantization Noise

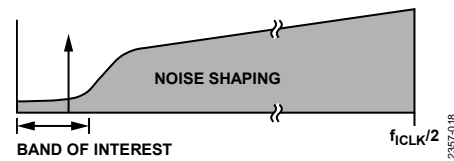

Figure 26. Σ - Δ ADC, Noise Shaping

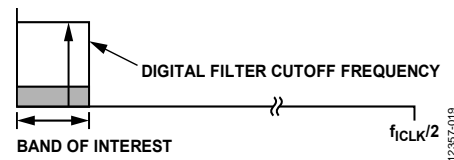

Figure 27. Σ - Δ ADC, Digital Filter Cutoff Frequency

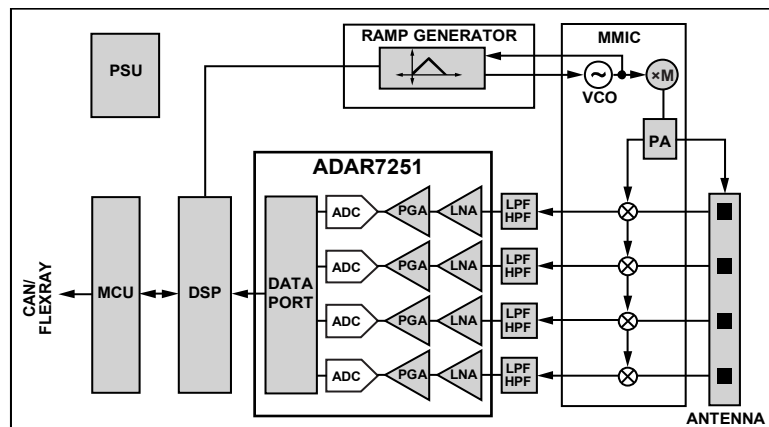

Figure 28. Radar System Overview

DIFFERENTIAL INPUT CONFIGURATION

The ADAR7251 main ADC input channel consists of an LNA, a PGA, a continuous time Σ - Δ ADC, and internal bias resistors that set the common-mode voltage on the input of the LNA. The PGA includes an equalizer (EQ) function that gains up low amplitude, high frequency signals. Typically, in an automotive radar application, the analog inputs of the ADAR7251 connect directly to the mixer output (See Figure 29). If additional external filtering is required, the external C1, C2, and C3 capacitors can be used. These capacitors, together with the R1, R2, and the mixer output impedance, create an external filter that removes dc components and high frequency noise from the ADC inputs.

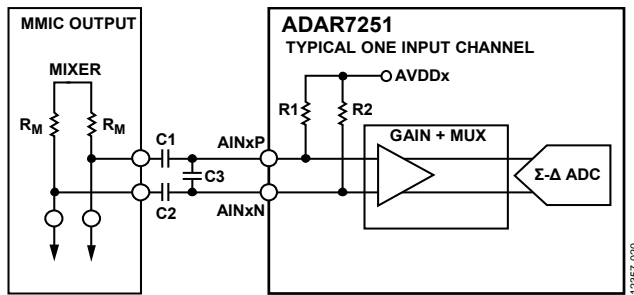

Figure 29. Typical Differential Input Channel Configuration

A monolithic microwave integrated circuit (MMIC) mixer output impedance, R_M , with Capacitor C3, forms a single-pole, low-pass filter that reduces high frequency spurs from the ADAR7251 inputs. Two capacitors, C1 and C2, with the ADAR7251 internal resistance of R1 and R2, produce a high-pass filter that removes dc components from the input signal.

Each Σ - Δ ADC input is preceded by its own LNA and PGA gain stage. The variable gain settings ensure that the device is able to amplify signals from a variety of sources. The ADAR7251 offers the flexibility to choose the most appropriate gain setting to utilize the wide dynamic range of the device. The ADAR7251 offers the flexibility to choose the most appropriate gain setting to utilize the wide dynamic range of the device. The LNA stage gain can be set using Register 0x100 in 6 dB steps. The default gain is 6 dB. The PGA gain can be set independently using Register 0x101 and has a default gain of 2.92 dB. The total LNA + PGA gain range is 36 dB. The gain settings, along with the ADAR7251 analog input range and channel noise specifications, are shown in the Specifications section (see Table 1). The default gain with LNA + PGA is 9 dB (2.8 \times), so that the full-scale differential input signal is 0.7 V rms. However, if a direct path is chosen and LNA + PGA is bypassed, the full-scale input signal to the ADC is 2 V rms differential.

High-Pass Filter (HPF)

The external input coupling capacitors form the passive first order, high-pass filter with the input impedance of the ADAR7251. This filter can also be used as a passive equalizer to boost the high frequency if desired. The corner frequency can be set to the desired frequency using the equation

$$f_{3dB} = 1/(2 \times \pi \times R1 \times C1)$$

where $R1 = R2$ (typical) is 2.86 k Ω and $C2 = C1$ (see Figure 29).

Low-Pass Filter (LPF)

The low-pass filter is formed by adding the capacitor across the differential input pins. The value of the source resistance driving the ADC dictates the corner frequency of the filter. Use the following equation to set the corner frequency to the desired frequency:

$$f_{3dB} = 1/(4 \times \pi \times R_M \times C3)$$

where R_M (typical) is the source resistance of the MMIC output.

Input Routing

Figure 30 shows the typical 2-channel input block with multiplexers and input signal routing inside the ADAR7251. For simplicity, the connections in Figure 30 are shown as single-ended, although they are differential.

The input signal can be routed through LNA + PGA, LNA + PGA + EQ, or direct to the ADC. Register 0x102 is used to select the multiplexer at the input of the ADC. The inputs to the ADC can be swapped between adjacent channels, for example, Channel 1 can be sent to ADC2 and the Channel 2 input can be sent to ADC1. In addition, the auxiliary Input 1 and Input 2 can be sent directly to the ADC. In this case, AUXIN1 becomes a noninverting input, and AUXIN2 becomes an inverting input to form a differential pair. The default path is LNA + PGA + ADC.

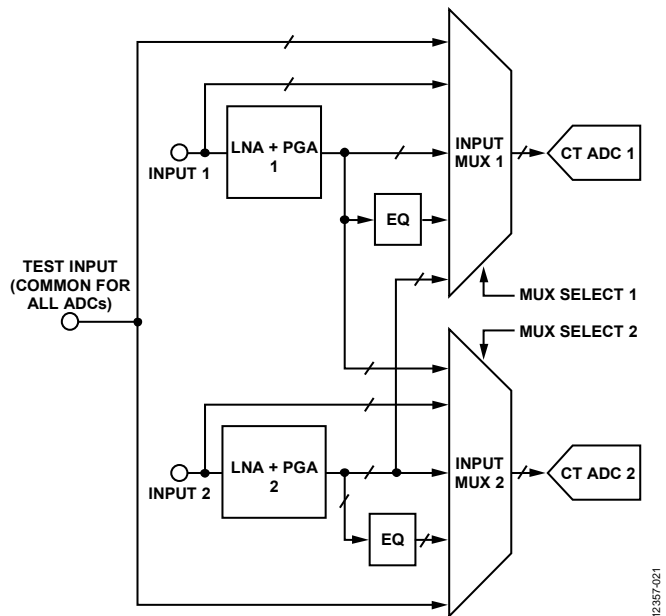

Figure 30. Typical 2-Channel Input Block

EQUALIZER (EQ)

The output of LNA + PGA can be routed to an equalizer block. In LSR-FMCW radar systems, the distance between the radar and the object affects signal amplitude and frequency. Distant objects have a higher frequency and smaller amplitude. The EQ provides frequency dependent gain to boost these signals. This provides easier detection of distant objects in a system. Excellent noise performance relies on an ultralow noise LNA at the beginning of the signal chain and a high precision ADC architecture. Enable the EQ path in Register 0x102. The EQ is a first order, high-pass

type. The cutoff frequency can be either 32 kHz (default), 37 kHz, 45 kHz, or 54 kHz. Select the EQ cutoff frequency in EQ_CAP_CTRL, Bits[1:0] in Register 0x301 (see Figure 20 in the Typical Performance Characteristics section).

USING LNA/PGA, EQ, OR THE INPUT CAPACITOR

The input passive filter, along with LNA + PGA and EQ, can be used to achieve the desired frequency response in the system. See Figure 31, Figure 32, and Figure 33 for typical examples.

Figure 31 shows the frequency response plot by varying the input coupling capacitor value, with the LNA + PGA gain and EQ fixed.

Figure 32 shows the frequency response plot by varying the LNA + PGA gain, with the input coupling capacitor and EQ fixed.

Figure 33 shows the frequency response plot by varying the EQ setting, with the input coupling capacitor and LNA + PGA gain fixed.

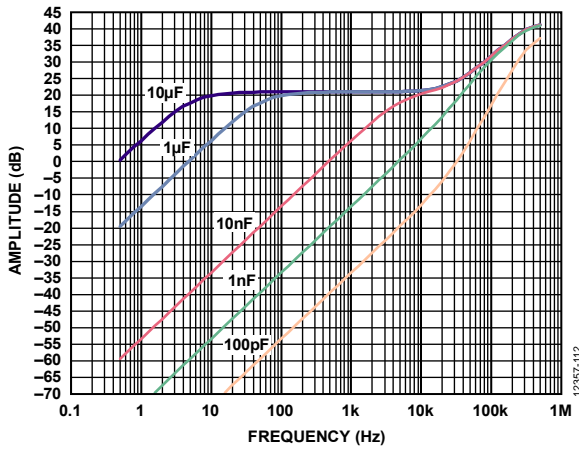

Figure 31. Frequency Response, Coupling Capacitor Change

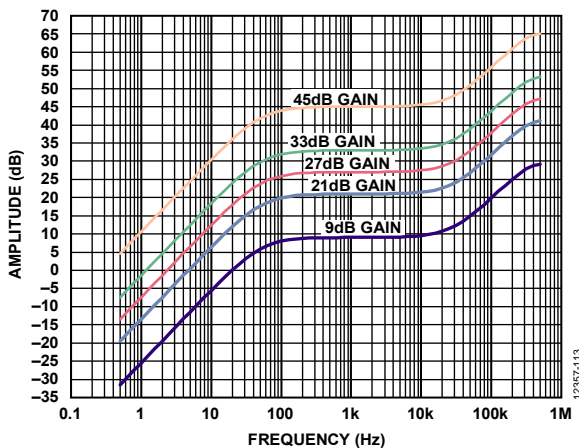

Figure 32. Frequency Response, Coupling Gain Change

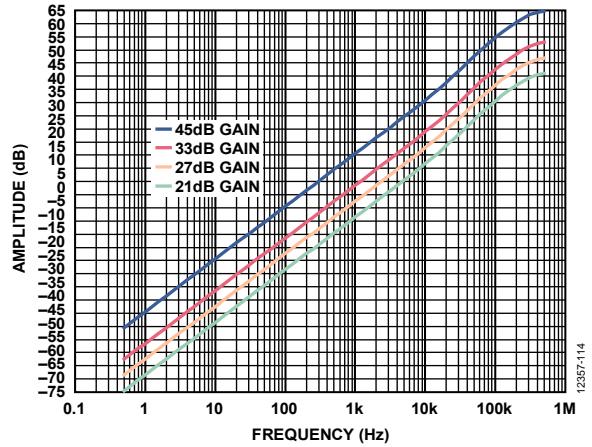

Figure 33. Frequency Response, Coupling EQ Change

REFERENCE

The internal reference of the ADAR7251 is set to 1.5 V. This 1.5 V reference is available at the CM pin. Decouple the CM pin to the AGNDx pin using a 10 µF MLCC in parallel with a 100 nF MLCC. The 1.5 V reference is current-limited and not designed to drive an external load. Employ an external buffer circuit if this reference is required for use with external circuits. The internal reference voltage can be overdriven externally if required.

AUXILIARY ADC

The ADAR7251 includes a 2-channel, auxiliary successive approximation register (SAR) ADC for low frequency housekeeping functions in the system. These functions include dc voltage monitoring and temperature monitoring. The auxiliary ADC uses AVDDx as the power supply; therefore, the input range is limited from 0 V to AVDDx. The ADC uses a time multiplexing technique to sample the two auxiliary inputs. The multiplexer in the front of the ADC selects the input for the conversion. The sample rate of the ADC is selectable between 112.5 kHz and 450 kHz. The default sample rate is 112.5 kHz. When 2-channel operation is selected, the set sample rate is the effective sample rate. If only one channel is selected, the effective sample rate is double the set value. The resolution of the ADC is eight bits, and the ADC output is straight binary. The ADC output is stored in the internal registers, which are read via the SPI port. Register 0x200 stores the current conversion value for Input 1 and Input 2. In addition, Register 0x201 stores the last sample value.

The ADC sample rate can be selected using Register 0x210, and Register 0x211 is used for selecting the input to the ADC. By default, the AUXINx pins are sampled. If the AUX_ADC_MODE bit (Bit 0 of Register 0x211) is set to 1, only one input is sampled at twice the sample rate. Because the auxiliary ADC is not continuous, care must be taken to ensure that the input signals are band limited and time multiplexed to prevent aliases.

The auxiliary ADC inputs are switched capacitor type; therefore, the input impedance is capacitive during the sampling phase. The typical source impedance must be less than 1 kΩ to ensure that the input settles before the sample value is held internally. The

source driving the ADC inputs must be able to drive at least 20 pF, excluding the parasitic capacitance on the board.

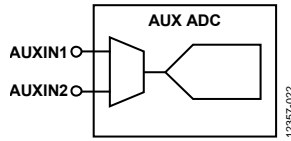

Figure 34. Auxiliary ADC

POWER SUPPLY

The ADAR7251 uses three supplies: 3.3 V for AVDDx, 1.8 V for DVDDx, and 3.3 V for IOVDDx. AVDDx and IOVDDx must be supplied to the device, but the supply to the DVDDx pins can be either generated by an internal LDO, or provided externally by turning off the LDO.

The AVDDx pins supply the analog core of the ADC, and the DVDDx pins supply the digital core of the ADC. The IOVDDx pins supply the digital input/output pins of the ADAR7251.

Decouple all power supplies to ground with a 0.1 μ F and a 10 μ F X7R MLCC for best ADC performance. The device provides the exposed pad underneath, which must be connected to the ground plane with thermal vias. All the ground pins must be connected to the single ground plane on the PCB with the shortest possible path close to the respective pins.

LDO

The internal LDO generates the DVDDx voltage (1.8 V) required for the digital core. The LDO takes the AVDDx (3.3 V) supply and regulates down to 1.8 V. External decoupling capacitors are required to ensure clean power to the digital core. If using the internal 1.8 V supply for the digital core, the REGOUT_DIGITAL pin must be externally connected to the DVDDx pins. The 1 nF MLCC, in parallel with 0.1 μ F and 10 μ F capacitors, are recommended at the DVDDx pins to decouple the high frequency noise.

CLOCK REQUIREMENTS

To achieve the specified dynamic performance, use an external crystal at the XIN/MCLKIN and XOUT pins. Alternatively, provide the single-ended clock at the MCLKIN input via an MCU/DSP controller. The ADAR7251 features an internal PLL block that accepts the clock frequency in a range of 16 MHz to 54 MHz, via either the clock available in the system, or an external crystal. An external clock must be connected to the XIN/MCLKIN pin and must be within the 0 V to 3.3 V p-p.

CRYSTAL OSCILLATOR

The external quartz crystal can be connected across the XIN and XOUT pins. When using the crystal, use Register 0x292 to enable the crystal oscillator block. The output of the crystal oscillator is an input to the PLL. The typical supported frequency range is 16 MHz to 54 MHz. Select load capacitors C1 and C2 for the crystal based on the recommendation of the crystal manufacturer. Determine the value of R1 based on the crystal current rating.

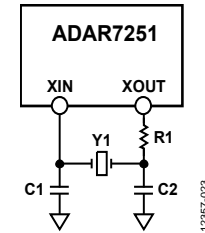

Figure 35. Crystal Oscillator

PLL

The PLL provides the stable clock for the internal blocks. It uses the clock input at the XIN/MCLKIN pin as a reference to generate the core clock. Set the PLL for either integer or fractional mode. The PLL multipliers and dividers (X, R, M, and N) are programmed using Register 0x000 to Register 0x003. The PLL can accept input frequencies in the range of 16 MHz to 54 MHz, either directly from an external source, or using the crystal connected at the XIN/MCLKIN and XOUT pins. The PLL output frequency is fixed at 115.2 MHz.

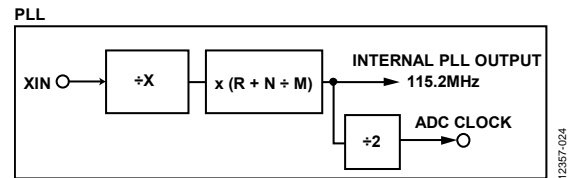

Figure 36. PLL Block Diagram

The PLL requires an external loop filter, which is fixed (see Figure 37). For temperature sensitive applications, the loop filter components must be appropriate. The PLL loop filter capacitors must be NPO type for best temperature performance.

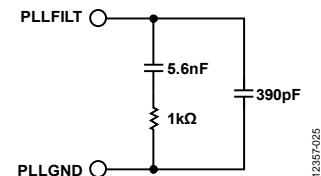

Figure 37. PLL Loop Filter

Place the PLL loop filter close to the PLLFILT pin to prevent crosstalk from other sources on the board. In addition, take care to decouple the PLLVDD supply to the PLL. It is recommended that X7R MLCC or better dielectric MLCCs of 1 nF be added in parallel with 0.1 μ F and 10 μ F capacitors close to the PLLVDD pin. See the PCB Layout Guidelines section for details.

Table 10 describes the registers used to set the PLL.

Table 10. Registers Used to Set the PLL

Register	Name	Description
0x000	CLK_CTRL	Uses the PLL output for the internal master clock, or bypasses the PLL
0x001	PLL_DEN	Sets the 16-bit denominator of the fractional part (M)
0x002	PLL_NUM	Sets the 16-bit numerator of the fractional part (N)
0x003	PLL_CTRL	Sets the PLL mode, PLL enable, 4-bit integer multiplier (R), and 4-bit integer divider (X)
0x005	PLL_LOCK	Checks the PLL lock status

The PLL can be used in either integer mode or fractional mode.

Integer Mode

Use integer mode when the input clock frequency is an integer multiple of the PLL output frequency, governed by the following equation:

$$f_{PLL} = (R/X) \times f_{IN}$$

where $f_{PLL} = 115.2$ MHz.

For example, if $f_{IN} = 19.2$ MHz, then

$$(R/X) = f_{PLL} (PLL \text{ Required Output}) / f_{IN} = 6$$

Therefore, R and X are set as follows: R = 6, and X = 1 (default).

To route the clock through the PLL, first set Register 0x000 to 0x0001.

In integer mode, the values set for N and M are ignored; leave Register 0x001 and Register 0x002 at default.

Table 11 shows the name, function, and required settings for the bits in Register 0x003.

Table 11. Required Writes for Register 0x0003, Integer Mode

Bits	Name	Function	Required Setting
[15:11]	PLL_INTEGER_DIV	Sets the R value	00110
[7:4]	PLL_INPUT_PRESCALE	Sets the X value	0001
1	PLL_TYPE	Sets the integer mode for the PLL	0
0	PLL_EN	Enables the PLL	1

Set Register 0x003 to 0011000000000001, that is, 0x3011. To check the status of the PLL, read Register 0x0005.

Fractional Mode

Fractional mode is used when the available clock input at XIN/MCLKIN is a fractional multiple of the desired PLL output; it is governed by the following equation:

$$f_{PLL} = f_{IN} \times (R + (N/M)) / X$$

For example, if XIN/MCLKIN = 16 MHz, the PLL output is 115.2 MHz.

To find the values of R, N, and M, use the following equation:

$$f_{PLL} = f_{IN} \times (R + (N/M)) / X$$

where:

$$f_{PLL} = 115.2 \text{ MHz.}$$

$$f_{IN} = 16 \text{ MHz.}$$

To find the values of R, N, M, and X, use the following equation:

$$(R + (N/M)) / X = 115.2 \text{ MHz} / 16 \text{ MHz} = 7.2 = 7 + (2/10)$$

Therefore, R, X, N and M can be set as follows: R = 7, X = 1 (default), N = 2, and M = 10.

To route the clock through the PLL, first set Register 0x000 to 0x0001. See Table 12 for the required register settings while in fractional mode.

Set Register 0x003 to 0011100000000001, that is, 0x3813. To check the status of the PLL, read Register 0x0005.

PLL Lock Acquisition

Register 0x005 is a read only register that indicates the PLL status. After writing the PLL settings, it is recommended to read the PLL lock status bit to ensure that the PLL is locked. A PLL_LOCK bit value of 1 indicates that the PLL is locked.

Table 12. Required Register Writes for Fractional Mode

Register	Bits	Name	Function	Required Setting
0x0001	[15:0]	PLL_DEN	Sets the M value	0000000000001010 (that is, 0x000A)
0x0002	[15:0]	PLL_NUM	Sets the N value	0000000000000010 (that is, 0x0002)
0x0003	[15:11]	PLL_INTEGER_DIV	Sets the R value	00111
	[7:4]	PLL_INPUT_PRESCALE	Sets the X value	0001
	1	PLL_TYPE	Sets the fractional mode for the PLL	1
	0	PLL_EN	Enables the PLL	1

GPIO

The ADAR7251 contains two GPIOs: Pin 28 and Pin 29. These pins are dual function. They serve as ADC data output pins in PPI mode, or as GPIOs in serial mode. These pins can be configured as inputs or outputs, and are read back or programmed via the SPI control interface. Register 0x250 and Register 0x251 are used for setting GPIO1 and GPIO2, respectively. Typical applications for these pins include monitoring the status of logic signals or controlling external devices. Use the GPIO pins for low speed serial communication. Configure the GPIO pins by writing to the GPIO configuration registers, Register 0x250 and Register 0x251. Note that, in these registers, the GPIO pins are referred to as the multipurpose (MPx) pins, Each GPIO pin has associated bits in the GPIO configuration register that define a status of the pin and whether the GPIO is used as an input or an output, as well as the debounce period. Register 0x260 and Register 0x261 can be used to output 1 or 0 to GPIO1 and GPIO2, respectively. Register 0x270 and Register 0x271 provide the read value from GPIO1 and GPIO2, respectively.

ADC DATA PORT

The ADAR7251 digital interface port provides multiple options for accessing the ADC data and connecting to DSP or micro-controllers in the system. The digital interface port can be set as serial mode or parallel mode.

Note that, throughout the remainder of the data sheet, multifunction pins are referred to by the relevant function in text and figures, where applicable.

ADC Serial Mode

The ADC serial port uses the conversion start pin (CONV_START), the frame sync pin (FS_ADC/ADC_DOUT7), the bit clock pin (SCLK_ADC), and two data output pins (ADC_DOUT0 and ADC_DOUT1). CONV_START can be disabled if it is not required in the system. The serial port can be set to either master or slave mode. The ADC output data is twos complement, 16-bit binary. Depending on the mode setup, the frame sync and bit clock pin directions change. In master mode, the ADAR7251 generates these signals, whereas in slave mode, these signals are provided by the external DSP. The ADC_DOUT0 and ADC_DOUT1 pins are always set as outputs, independent of the master or slave mode. The data format is fixed to MSB first. The serial port is powered using the IOVDDx supply. Take proper care to ensure decoupling of the high frequency noise on this pin to prevent jitter on the clock and data outputs. Connect a 100 nF MLCC is recommended to be connected to the IOVDDx pins as close as possible with direct connection to the DGNDx pins and a ground plane on the board.

Because the bit clock rate is in the 40 MHz range, traces on the board require proper attention. The bit clock and data pin (ADC_DOUTx) must be traced out with transmission line considerations. If the clock is connected to multiple devices, the stubs must be properly terminated to reduce reflections. Microstrip or stripline traces are recommended for these pins. Increase the

drive strength for the digital output pins using Register 0x0280 through Register 0x292. The ADAR7251 consists of four ADCs. Data is available in two pairs on the ADC_DOUT0 and ADC_DOUT1 pins: Channel 1 and Channel 2 on ADC_DOUT0, and Channel3 and Channel 4 on ADC_DOUT1 in 2-channel mode. Each channel uses 16 bits; for two channels, 32-bit clocks are required. The frame sync signal (FS_ADC) sets the sample rate for the ADC. Therefore, the typical bit clock rate for a sample rate of 1.2 MHz is

$$32 \times 1.2 \text{ MHz} = 38.4 \text{ MHz}$$

ADC Serial Master Mode

In master mode, the ADC generates the bit clock (SCLK_ADC) and frame sync (FS_ADC) signals. The sample rate is restricted to a maximum of 1.2 MHz in serial mode. Two pins are provided for the serial data: ADC_DOUT0 and ADC_DOUT1. By default, each pin provides the two channel output. In addition, all four channels can be output from one data pin, ADC_DOUT0. The bit clock rate depends on the sample rate and the number of channels per data pin used. See Table 13 for available options. Figure 38 shows the typical connections diagram for ADC serial master mode

Table 13. Bit Clock Rate Options for ADC Serial Mode

Number of Channels per ADC_DOUT0/ADC_DOUT1 Pin	FS_ADC (MHz)	SCLK_ADC (MHz)
2	0.3	9.6
4	0.3	19.2
2	0.45	14.4
4	0.45	28.8
2	0.6	19.2
4	0.6	38.4
2	0.9	28.8
4	0.9	57.6
2	1.2	38.4
4	1.2	Not applicable
2	1.8	57.6 ¹
4	1.8	Not applicable

¹ Supported in master mode only.

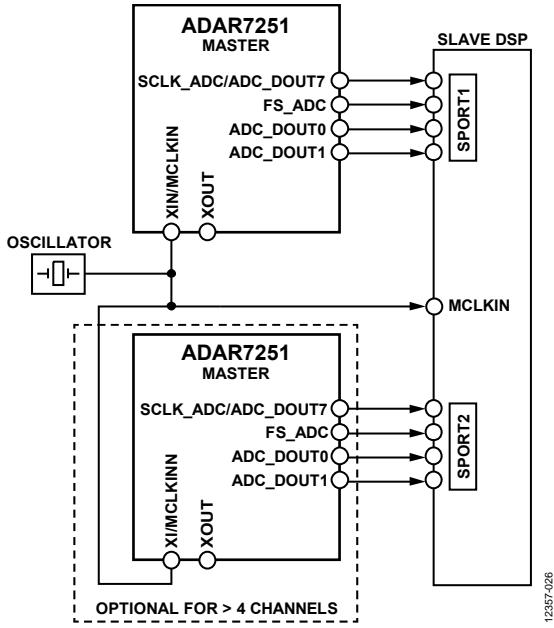

Figure 38. Typical Connection Diagram for ADC Serial Master Mode

Figure 41 and Figure 42 show the waveforms for the serial modes without the CONV_START signal.

ADC Serial Master Mode with CONV_START

The ADC provides the CONV_START signal to synchronize the ADC conversion data with an external ramp signal used in a FMCW system. Use the CS_OVERRIDE bit (Register 0x1C2, Bit 1) to enable or disable the CONV_START signal. This bit is disabled by default. When the CS_OVERRIDE bit is enabled with ADC serial master mode, the serial port waits for the CONV_START signal from the external DSP or MCU in the system. The CONV_START signal is used to indicate the start of the ramp signal in the system. The CONV_START signal is active low and needs an external pull-up resistor to IOVDDx. When the CONV_START signal is high, the ADC remains running internally, but the data and clocks are not output from the serial port. Therefore, there is no data output to the external DSP while this signal is logic high. When the CONV_START signal goes low, indicating the start of the ramp signal, the serial port starts outputting the clocks and data. The external DSP can grab the data on the ADC serial port based on the frame sync and serial clock. The data is synchronous to the external ramp signal.

The following precautions must be taken into account while using ADC serial master mode with CONV_START:

- The very first sample data may not be complete and may need to be ignored. This is because the CONV_START signal is asynchronous to the internal ADC clocks, and may request the data anywhere in the middle of the internal frame sync signal.
- The digital filter sync enable bit in Register 0x30E is used to synchronize the internal digital filter to the serial port clocks. This bit is enabled by default, therefore, the digital filter

attempts to synchronize to the serial port clocks. In serial master mode, this bit must be disabled by writing 0x0000 to Register 0x30E. This is an important step because the digital filter is already synchronized to the internal serial port clocks and does not need to be resynchronized based on the external asynchronous demand of the CONV_START signal. See Figure 39 for waveforms.

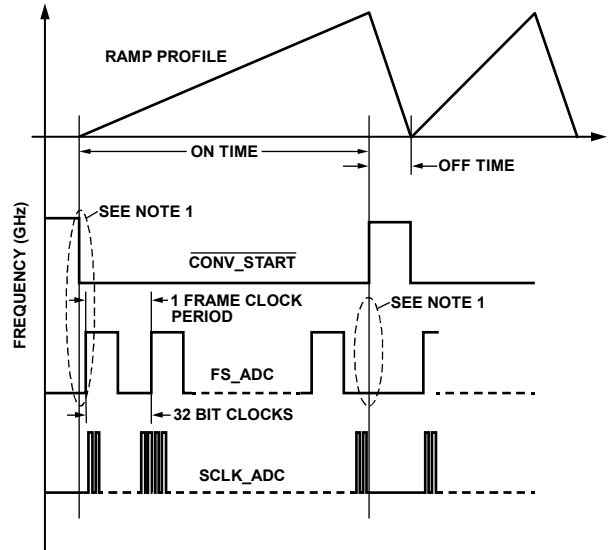

NOTES
1. IGNORE FIRST AND LAST SAMPLES BECAUSE CONV_START IS NOT SYNCHRONOUS TO INTERNAL ADC CLOCK.

Figure 39. Typical Timing Waveforms for ADC Serial Master Mode with CONV_START

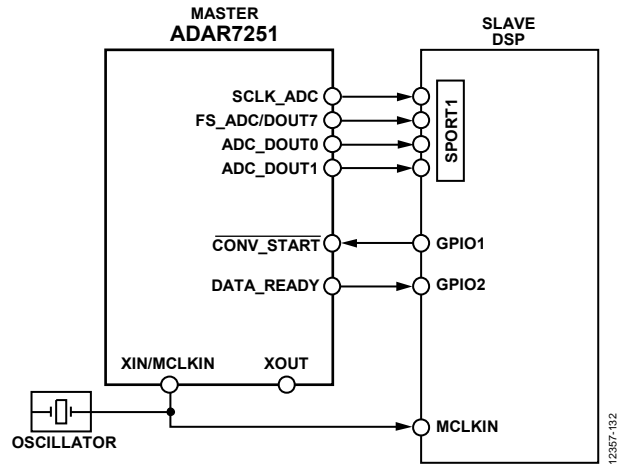

Figure 40. ADC Serial Master Mode with CONV_START

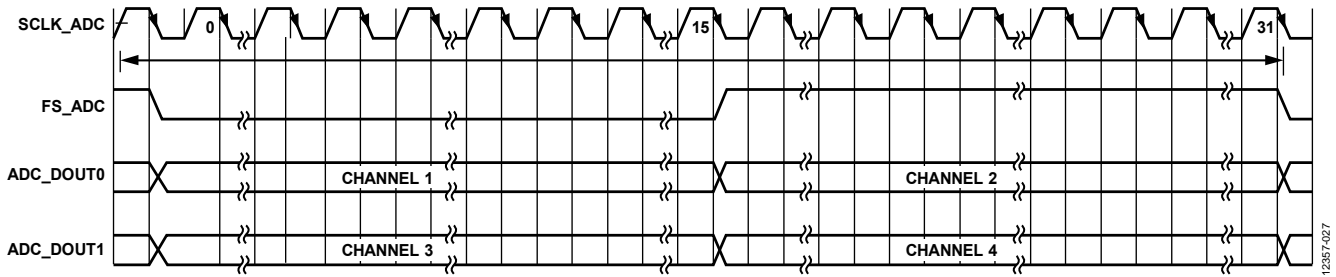

Figure 41. Serial Mode, Two Channels per the ADC_DOUTx Pins

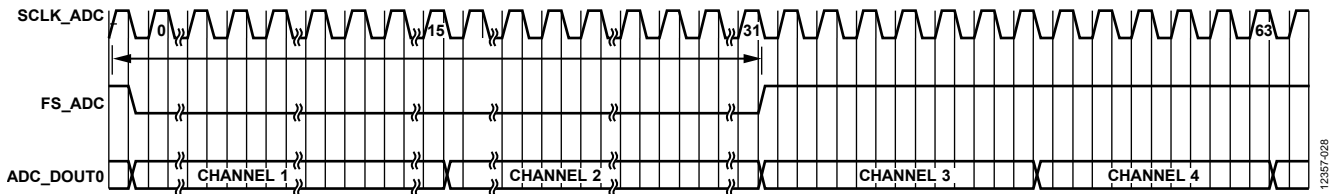
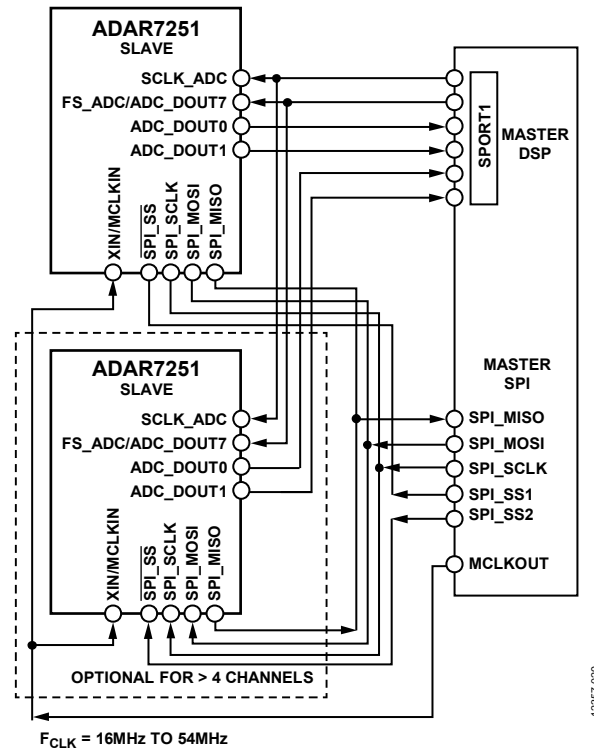

Figure 42. Serial Mode, 4 Channels per the ADC_DOUTx Pins



F_{CLK} = 16MHz TO 54MHz

Figure 43. Typical Connection Diagram for ADC Serial Slave Mode

ADC Serial Slave

Figure 43 shows the typical connection diagram for ADC serial slave mode. In this mode, the directions of the frame sync and bit clock pins change. Both pins are inputs and must be provided with bit clock and frame sync signals via an external DSP. The ADC_DOUT0 and ADC_DOUT1 pins are always used as outputs. The data format is fixed as MSB first. The ADC must be provided with master clock from the DSP to synchronize the ports.

ADC PPI (Byte Wide Mode)

ADC PPI mode is parallel byte wide mode and, in this mode, the device is always master. In this mode, the ADC outputs the bit clock and data. Provide the ADC port with a conversion start

signal (CONV_START) if selected. This initiates the conversion process. When the ADC is ready with conversion data, it pulls the DATA_READY pin high to indicate the data ready status to the DSP. The ADC then provides the bit clock, SCLK_ADC. The data is available on the rising edge of the bit clock. The maximum sample rate supported is 3.6 MHz in this mode. The data is available on the ADC_DOUT0 through ADC_DOUT7 pins, one byte at a time. The ADC data is twos complement, 16-bit binary, but the 16-bit data is split into two bytes: a higher byte and a lower byte (each is 8 bits wide). The higher byte is output first, and is followed by the lower byte. The bit clock (SCLK_ADC) rate depends on the sample rate setting. See Table 14 for available options. Note that in the PPI mode, the FS_ADC output is not

available. This mode may be useful if the DSP port cannot support the 38.4 MHz data rate. The data rate is less than that of the serial port; however, it uses more pins for data.

Table 14. Bit Clock Rate Options for ADC PPI Byte Wide Mode

Number of Channels	FS_ADC (MHz)	SCLK_ADC (MHz)	Data Output Pins
2	1.2	4.8	ADC_DOUT0 through ADC_DOUT7
4	1.2	9.6	ADC_DOUT0 through ADC_DOUT7
2	1.8	7.2	ADC_DOUT0 through ADC_DOUT7
4	1.8	14.4	ADC_DOUT0 through ADC_DOUT7

The other sample rates supported are 300 kHz, 600 kHz, 900 kHz, 2.4 MHz, and 3.6 MHz. The highest serial clock supported is 57.6 MHz. However, as the sample rate increases beyond 1.2 MHz, the ADC resolution decreases. At the highest sample rate of 3.6 MHz, the ADC resolution is limited to 11 bits.

Figure 44 shows the typical connections diagram for ADC PPI master mode.

Figure 45 and Figure 46 show waveforms for PPI 2-channel and PPI 4-channel mode.

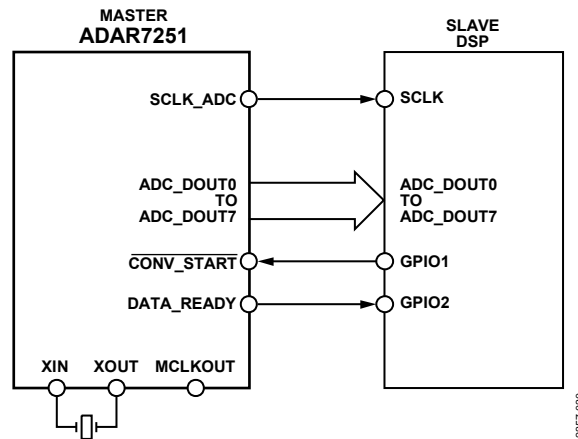

Figure 44. Typical Connection Diagram for ADC PPI Master Mode

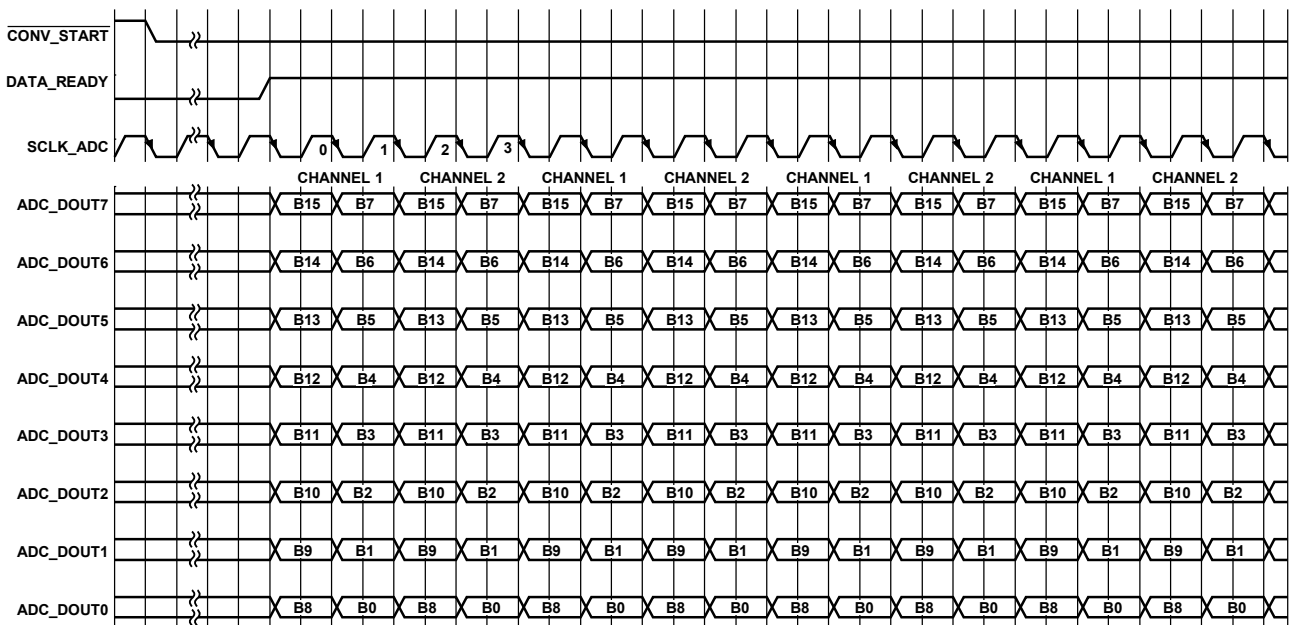

Figure 45. PPI, 2-Channel

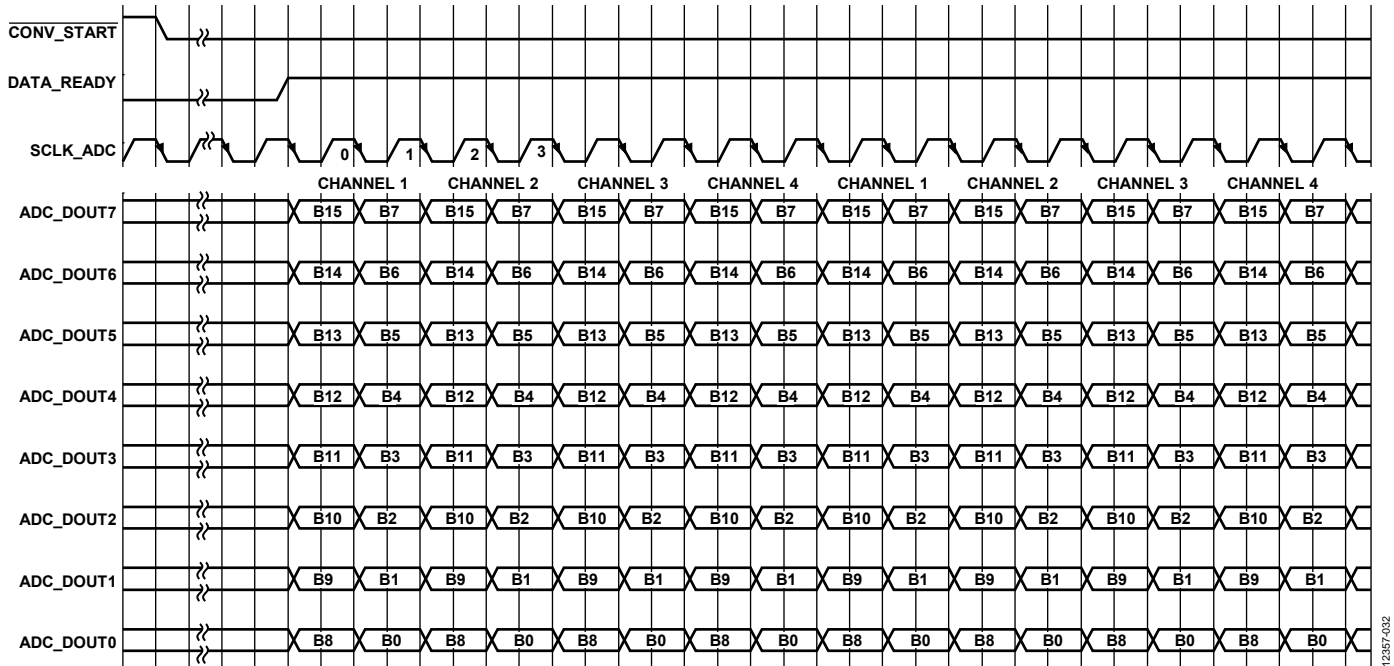

Figure 46. PPI, 4-Channel

Table 15. Bit Clock Rate Options for ADC PPI Nibble Wide Mode

Number of Channels	FS_ADC (MHz)	SCLK_ADC (MHz)	Data Output Pins
2	1.2	9.6	ADC_DOUT0 through ADC_DOUT3
4	1.2	19.2	
2	1.8	14.4	
4	1.8	28.8	

ADC PPI Nibble Wide Mode

ADC PPI nibble wide mode differs from byte wide mode in that the data is transferred in nibble form (four bits at a time) instead of in byte wide mode (eight bits at a time). In master mode, the ADC outputs the bit clock and data. Provide the ADC port with a conversion start (CONV_START); this initiates the conversion process. When the ADC is ready with the conversion data, it pulls the DATA_READY pin high to the DSP. The ADC then provides the bit clock, SCLK_ADC. The data is available on the rising edge of the bit clock. The maximum sample rate supported is 3.6 MHz in this mode. The data is available on the ADC_DOUT0 through ADC_DOUT3 pins, one nibble at a time. The 16-bit data is split into four nibbles each, 4 bits wide. The higher nibble is output first, followed by the lower nibble. The bit clock (SCLK) rate depends on the sample rate setting. See Table 15 for available options. This mode may be useful if the DSP cannot support the 8-bit wide data port. The data rate is twice that of the PPI byte wide mode; however, it saves four pins.

DAQ Mode

DAQ mode is designed specifically for FSK radar applications. In this mode, the ADC synchronizes with the FSK clock. Both serial

and PPI modes are supported, but are limited to master mode. The typical connections for the ADC serial master mode (see Figure 48) and PPI master mode(see Figure 44) are valid. In DAQ serial mode, the SCLK_ADC is fixed at 38.4 MHz, whereas the clock rate is adjustable in PPI mode.

Figure 50 shows the typical operation sequence for the DAQ serial mode with two channels per data line.

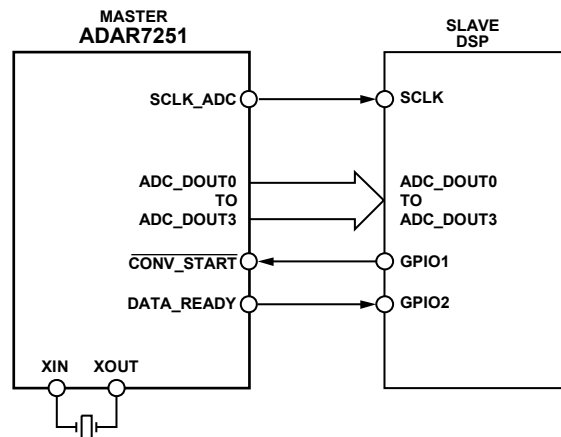

Figure 47. Typical Connection Diagram for PPI Nibble Wide Mode

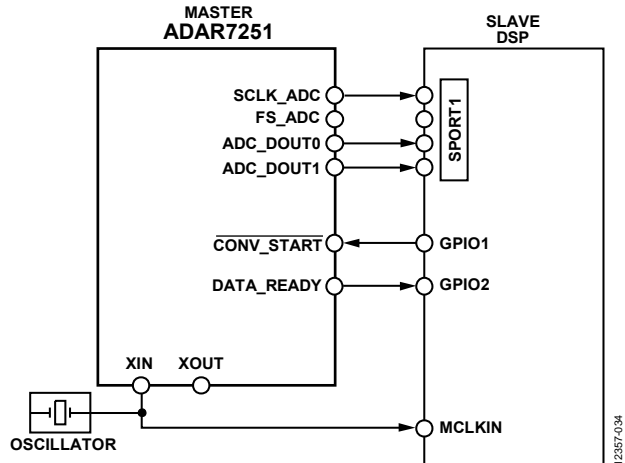

Figure 48. Typical Connection Diagram for DAQ Serial Master Mode

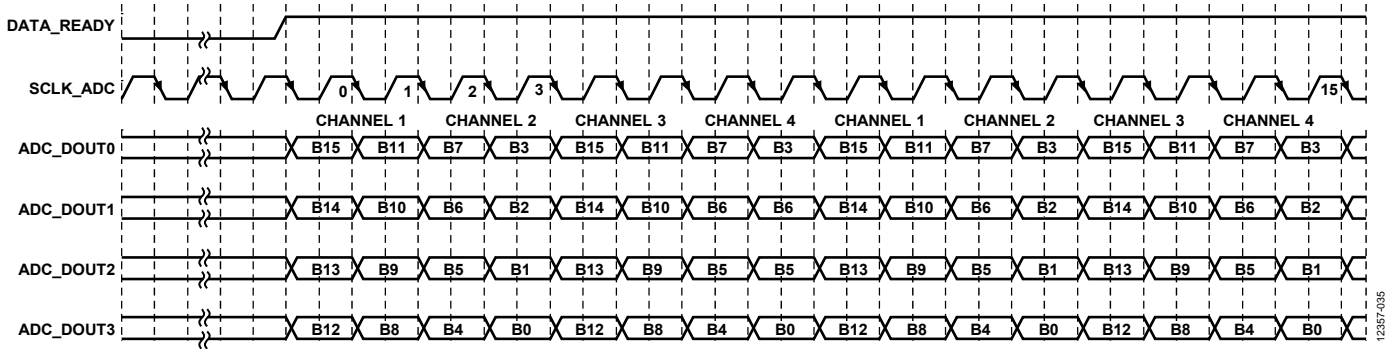

Figure 49. PPI, 4-Channel Nibble Wide Mode

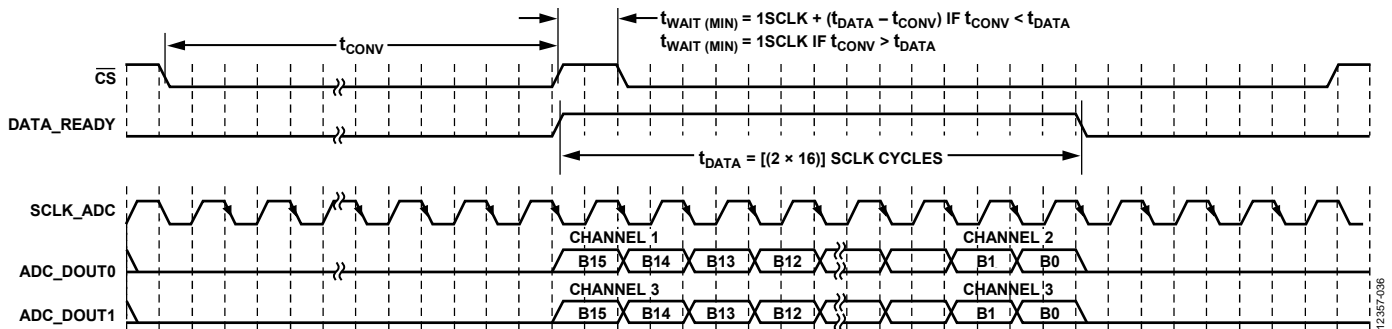

Figure 50. DAQ Serial Master, Two Channels Per Pin

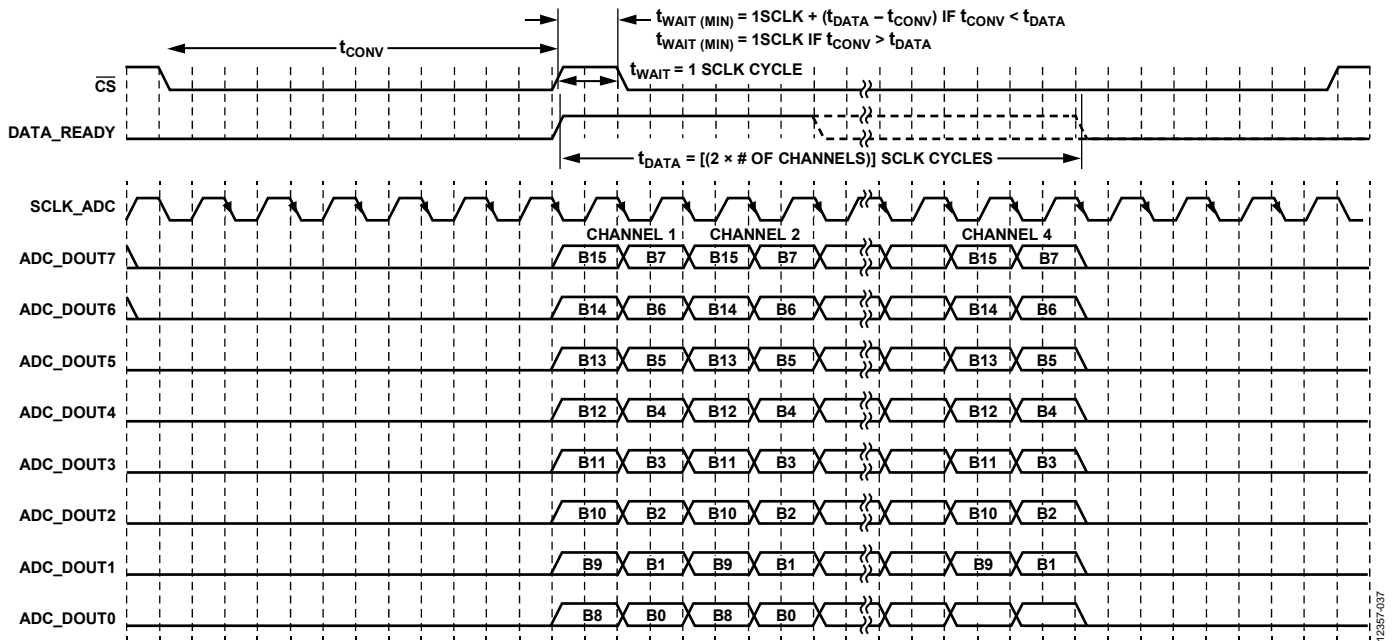

Figure 51. DAQ PPI Master Mode

The high to low transition on the CONV_START signal starts the conversion process. The ADC signals set the DATA_READY signal high. Data is available at the next clock cycle. Two channels per pin are supported in serial mode, whereas two or four channels are supported in PPI mode. The SCLK frequency determines the total time required for the data (t_{DATA}). This value is typically 32-bit clock cycles for serial mode and $(2 \times$ the number of channels) of bit clock cycles in PPI mode. The fastest data rate available is 57.6 MHz in 2-channel, PPI, 16-cycle acquisition mode. The maximum data rate in DAQ serial mode is 38.4 MHz and is fixed. The frequency of the CONV_START signal dictates the sample rate of the ADC in DAQ mode. Calculate the sampling frequency in DAQ mode as

$$f_{s \text{ DAQ_MODE}} = 1/(t_{CONV} + t_{WAIT})$$

where:

$t_{DATA} < t_{CONV}$.

t_{CONV} is the time required for the conversion.

t_{WAIT} is the time required to wait before another conversion start can be initiated.

t_{DATA} is the time the data is available on the ADC_DOUTx pins.

Table 16 shows the supported modes and typical acquisition times in DAQ mode.

Table 16. Acquisition Times in DAQ Mode

Acquisition Cycles	t_{CONV} (μ s)
16	1.2
24	1.8
32	2.4

Using Multiple ADAR7251 Devices for Systems with More Than Four Channels

The ADAR7251 offers flexible serial port for multichannel applications requiring more than four channels. The typical connection diagram is shown in Figure 52.

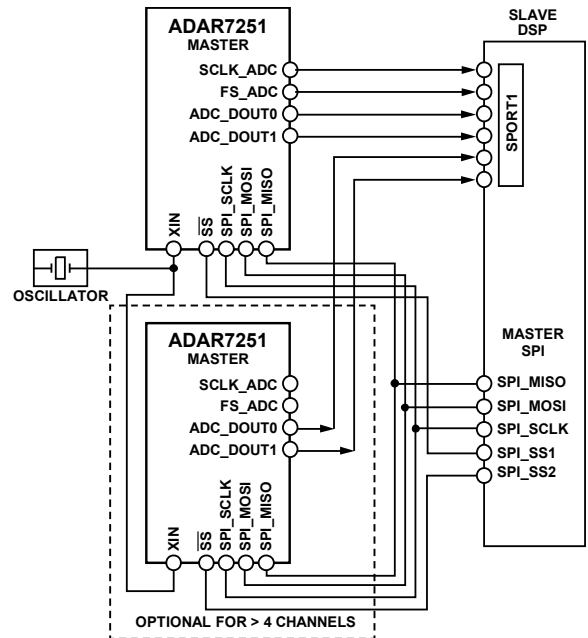

Figure 52. Connecting Multiple ADAR7251 Devices for an 8-Channel System

Multiple ADAR7251 devices can be configured using a single SPI master and clock oscillator to synchronize the PLLs of both devices. For the system to function, it is recommended to have both the ADCs on the same board and within a few inches of each other. Both the devices act as master, but only one ADAR7251 supplies the bit clock and frame sync signal to the DSP port, which is slave. This connection option may save the

extra serial port (SPORT) on the DSP. This works because both PLLs are synchronized to one master clock and are enabled at the same time using a single SPI master. SPI writes must be written to both devices simultaneously. For this to work, the $\overline{\text{SPI_SS}}$ pin of both devices must be selected at the same time. The SPI reads, however, can be performed independently for both devices.

SPI CONTROL PORT

The ADAR7251 control port uses a 4-wire SPI. The SPI port sets the internal registers of the device. The SPI allows read and write capability of the registers. All the registers are 16 bits wide. The SPI control port supports Mode 11 (clock polarity = 1 and clock phase = 1), slave only and, therefore, requires the master in the system to operate. The registers cannot be accessed without the master clock to the device. It is recommended to configure the PLL first to achieve full speed on the control port. The port is powered by IOVDDx, and control signals must be within the IOVDDx limits. The serial control interface also allows the user to control auxiliary functions of the device such as the GPIOs and the auxiliary ADC.

Table 17 shows the functions of the control port pins in SPI mode.

Table 17. Control Port Pin Functions

Pin No.	Mnemonic	Pin Function	Pin Type
32	ADDR15	Sets the device address for the SPI	Input
38	SPI_MISO	SPI port outputs data from the ADAR7251	Output
39	SPI_MOSI	SPI port inputs data to the ADAR7251	Input
40	SPI_CLK	SPI clock to the ADAR7251	Input
41	$\overline{\text{SPI_SS}}$	SPI slave select to the ADAR7251	Input

The SPI port uses a 4-wire interface, consisting of the $\overline{\text{SPI_SS}}$, SPI_CLK, SPI_MOSI, and SPI_MISO signals. The SPI port is always a slave port. The $\overline{\text{SPI_SS}}$ (slave select) selects the device. The SPI_CLK is the serial clock input for the device, and all data transfers (either SPI_MOSI or SPI_MISO) take place with respect to this clock signal. The SPI_MOSI pin addresses the on-chip registers and transfers data to these registers. The SPI_MISO pin outputs data from the on-chip registers.

The $\overline{\text{SPI_SS}}$ goes low at the beginning of a transaction and high at the end of a transaction. The SPI_CLK signal samples SPI_MOSI on a low to high SPI_CLK transition; therefore, the data to be written to the device must be stable during this edge. The data shifts out of the SPI_MISO on the falling edge of the SPI_CLK and must be clocked into a receiving device, such as a microcontroller, on the SPI_CLK rising edge. The SPI_MOSI signal carries the serial input data to the ADAR7251, and the SPI_MISO signal carries the serial output data from the device. The SPI_MISO signal remains tristated until a read operation is requested. This allows direct connection to other SPI-compatible

peripheral SPI_MISO ports for sharing the same system controller port. All SPI transactions have the same basic format shown in Table 19. Figure 2 shows an SPI port timing diagram. All data must be written MSB first.

Device Address R/W

The LSB of the first byte of an SPI transaction is a $\overline{\text{R/W}}$ bit. This bit determines whether the communication is a read (Logic level 1) or a write (Logic Level 0). This format is shown in Table 18.

Table 18. SPI Address and R/W Byte Format

Bit 7	Bit 6	Bit 5	Bit 4	Bit 3	Bit 2	Bit 1	Bit 0
0	0	0	0	0	0	ADDR15	$\overline{\text{R/W}}$

The ADDR15 pin (Pin 32) determines the address of the device. The device reads the status of this pin on power-up and uses the device address. A 47 kΩ typical resistor must be used to set the device address by using a pull-down resistor to ground or a pull-up resistor to the IOVDDx pins. Pin 32 is multifunctional and is also used as a data output in PPI mode. The $\overline{\text{R/W}}$ bit setting determines if the device is used for an SPI write or SPI read operation. When the $\overline{\text{R/W}}$ bit is set to 0, it is used for an SPI write operation; when it is set to 1, it is used for an SPI read operation.

Register Address

The registers address field is 16 bits wide. The registers start at Register 0x000.

Data Bytes

The register data field is 16 bits wide.

CRC

The ADAR7251 provides the user with a 16-bit cyclic redundancy check (CRC) for SPI read and writes to the device, and for data communication error detection. The CRC is enabled by default and can be disabled if not required.

Disable the CRC by writing 0x0001 to Register 0xFD00. This SPI write disables the CRC function. With the CRC disabled, the SPI read and write sequence is conventional.

Table 19 shows the typical single read/write byte sequence without the CRC; this sequence typically requires 40 clock cycles or 5 bytes. The typical 5-byte sequence consists of Byte 0 for the device address with the $\overline{\text{R/W}}$ bit. The next two bytes, Byte 1 and Byte 2, contain the register address followed by Byte 3 and Byte 4, which carry the data to or from the register.

A sample timing diagram for a single-word SPI write operation to a register is shown in Figure 53. Figure 54 show a single-word SPI read. During the read operation, the SPI_MISO pin goes from being high impedance (high-Z) to output at the beginning of Byte 3.

Figure 55 and Figure 56 shows the typical sequence for the multiple byte SPI read and writes.

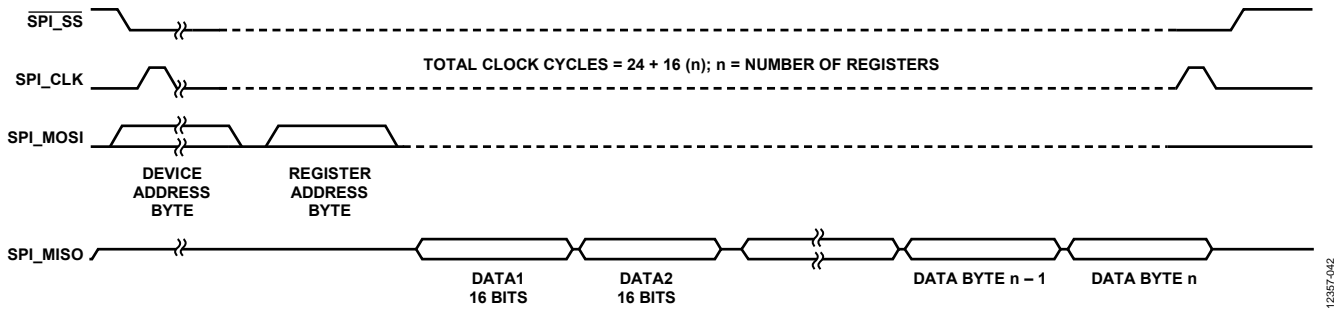
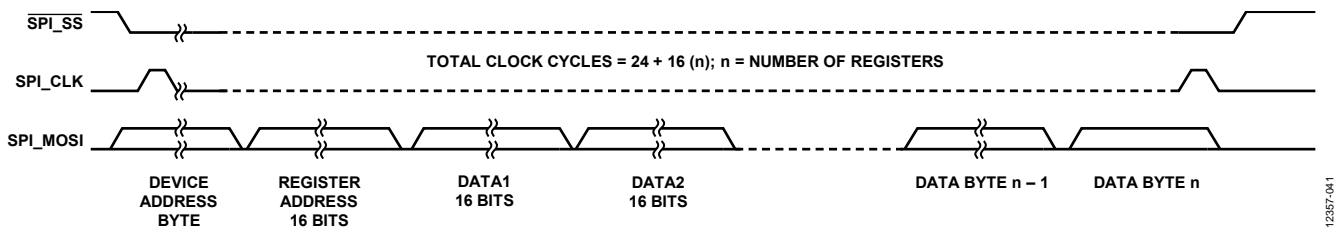
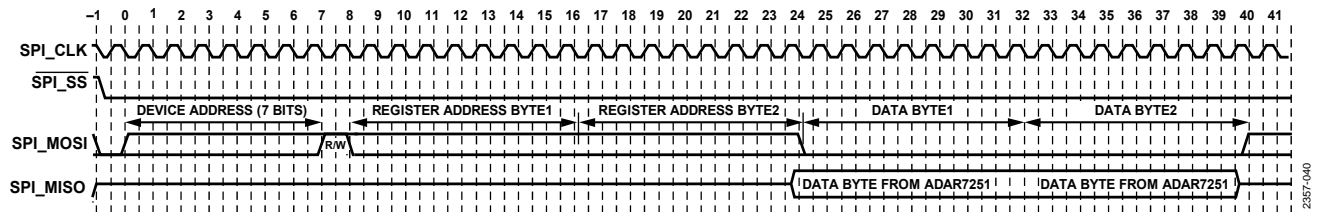
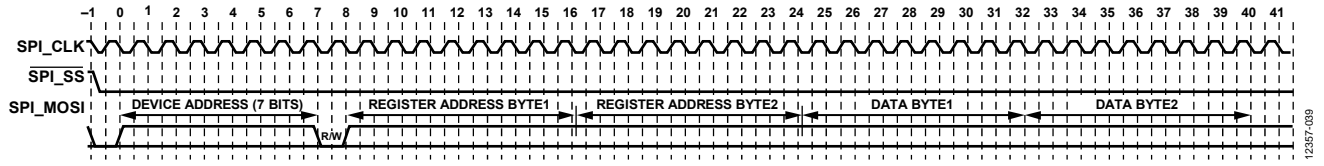

Table 19. Single SPI Write or Read Format

Operation	Byte 0	Byte 1	Byte 2	Byte 3	Byte 4
Write	Device Address[6:0], R/W = 0	Register Address[15:8]	Register Address[7:0]	Data[15:8]	Data[7:0]
Read	Device Address[6:0], R/W = 1	Register Address[15:8]	Register Address[7:0]	Data[15:8]	Data[7:0]

Table 20. Single Register Write with CRC

Device Address	Register Address	Register Data	CRC
1 byte 00	2 bytes XXXX ¹	2 bytes XXXX ¹	2 bytes XXXX ¹

¹ X means don't care.

If the CRC is enabled, the 16-bit CRC must be included in the SPI write following the register and data bytes. Any SPI write that does not include valid CRC bits is ignored. The SPI write with CRC included is as follows for single or multiple registers:

1. The CRC is calculated based on the data, excluding the device address byte.
2. The CRC polynomial used is $(x^{16} + x^{15} + x^{12} + x^7 + x^6 + x^4 + x^3 + 1)$, that is, xC86Ch.
3. The two calculated, 16-bit CRC bytes must be appended to the SPI writes along with the register address and data bytes for valid transaction.

The SPI read is limited to 8 bytes (see Table 22).

Three registers must be read one at a time to achieve the CRC. The device address is excluded from the eight bytes. The last two bytes represent the CRC bytes after the eight bytes (two bytes of the register address + six bytes of the register data).

If during the SPI write the invalid CRC is included, the expected CRC value of the last SPI transaction is stored in

Register 0x084 and Register 0x085. Register 0x084 stores the lower byte, and Register 0x085 stores the higher byte. The lower and upper bytes combined form the 16-bit CRC value expected in the SPI write sequence.

Register 0x086 enables the CRC calculation for the whole register map. It is enabled by default. Register 0x087 stores the flag that indicates the CRC calculation status. A value of 1 indicates that the CRC calculation is ready.

In addition, the CRC value for the whole register map is stored in Register 0x088 and Register 0x089. Register 0x088 stores the lower byte, whereas Register 0x089 stores the higher byte.

Register 0x084, Register 0x085, Register 0x087, Register 0x088, and Register 0x089 are read only.

Figure 57 and Figure 58 show the SPI read and write operations with the CRC.

Table 21. Multiple Register Write with CRC

Device Address	Register Address	Register Data	Register Data	Register Data	CRC
1 byte 00	2 bytes XXXX ¹	2 bytes XXXX ¹	2 bytes XXXX ¹	2 bytes XXXX ¹	2 bytes XXXX ¹

¹ X means don't care.

Table 22. Register Read with CRC

Device Address	Register Address	Register Data	Register Data	Register Data	CRC
1 byte 01	2 bytes XXXX ¹	2 bytes XXXX ¹	2 bytes XXXX ¹	2 bytes XXXX ¹	2 bytes XXXX ¹

¹ X means don't care.

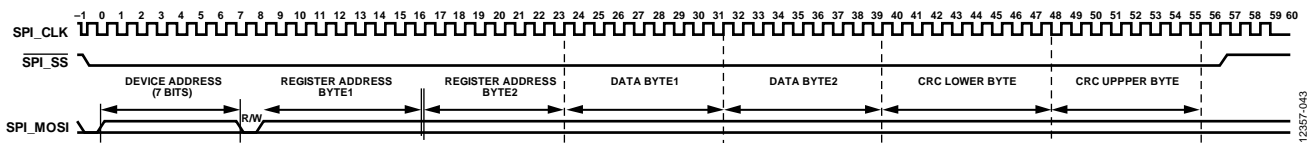

Figure 57. SPI Single Write with CRC

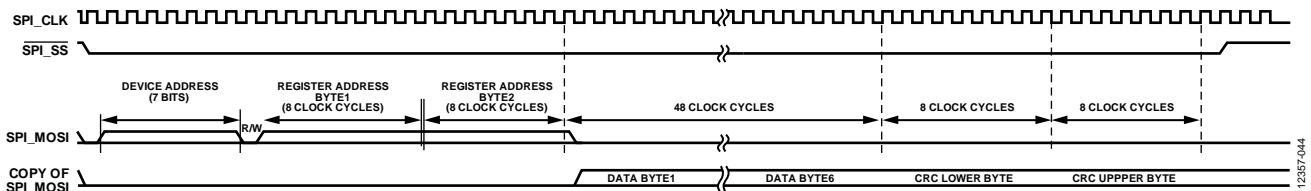

Figure 58. SPI Read with CRC

PCB LAYOUT GUIDELINES

The printed circuit board (PCB) layout is an important consideration, as is the component placement of the decoupling capacitors. Figure 59 shows the component placement for some of the decoupling capacitors. The decoupling components for AVDDx, DVDDx, IOVDDx, CM, BIASP, BIASN, REGOUT_DIGITAL, and PLLFILT must be placed close to the device. The 1 nF and 100 nF MLCCs must be placed close to their respective pins and on the same layer as the device. The bulk 10 μ F capacitor can be placed further from the pins. The exposed pad underneath the device must be soldered to the ground plane on the PCB with thermal vias. The recommended

footprint for the thermal pad is available at <http://www.analog.com/en/content/package-information/fca.html>. The typical recommended board stackup is four layers with the top and bottom layers used for signaling, the second layer as the ground plane, and the third layer as the power plane. Ensure that the ground plane is contiguous without breaks for the best EMI and thermal performance. During the board layout, use the SCLK_ADC and ADC_DOUTx signals as a transmission line to maintain the signal integrity.

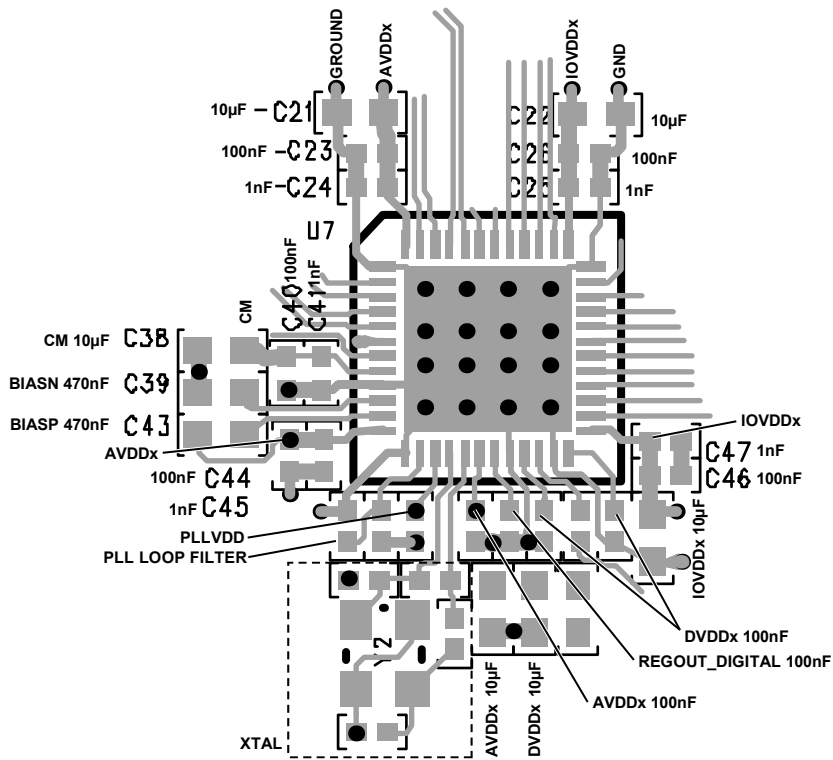

Figure 59. Recommended PCB Layout

REGISTER SUMMARY

Table 23. Register Summary

Reg	Name	Bits	Bit 7	Bit 6	Bit 5	Bit 4	Bit 3	Bit 2	Bit 1	Bit 0	Reset	RW	
0x000	CLK_CTRL	[15:8] [7:0]	RESERVED[15:8] RESERVED[7:0]								PLL_BYPASS	0x0001	RW
0x001	PLL_DEN	[15:8] [7:0]	PLL_DEN[15:8] PLL_DEN[7:0]									0x0000	RW
0x002	PLL_NUM	[15:8] [7:0]	PLL_NUM[15:8] PLL_NUM[7:0]									0x0000	RW
0x003	PLL_CTRL	[15:8] [7:0]	PLL_INTEGER_DIV				RESERVED		RESERVED		RESERVED[2:0] PLL_TYPE PLL_EN	0x0000	RW
0x005	PLL_LOCK	[15:8] [7:0]	RESERVED[15:8] RESERVED[7:0]								PLL_LOCK	0x0000	R
0x040	MASTER_ENABLE	[15:8] [7:0]	RESERVED[14:7] RESERVED[6:0]								MASTER_EN	0x0000	RW
0x041	ADC_ENABLE	[15:8] [7:0]	RESERVED LN_PG4_EN LN_PG3_EN LN_PG2_EN LN_PG1_EN ADC4_EN ADC3_EN ADC2_EN ADC1_EN									0x00FF	RW
0x042	POWER_ENABLE	[15:8] [7:0]	RESERVED FLASH_LDO_EN LDO_EN AUXADC_EN MP_EN DIN_EN POUT_EN						CLOCK_LOSS_EN	RESERVED SOUT_EN CLKGEN_EN	0x03FF	RW	
0x080	ASIL_CLEAR	[15:8] [7:0]	RESERVED[14:7] RESERVED[6:0]								ASIL_CLEAR	0x0000	RW
0x081	ASIL_MASK	[15:8] [7:0]	RESERVED[1:0]		CLK_LOSS_MASK	BRN_GOOD_MASK	BRP_GOOD_MASK	VR_GOOD_MASK	OVERTEMP_MASK	CRC_MASK	0x0000	RW	
0x082	ASIL_FLAG	[15:8] [7:0]	RESERVED[14:7] RESERVED[6:0]								ASIL_FLAG	0x0000	R
0x083	ASIL_ERROR	[15:8] [7:0]	RESERVED[1:0]		CLK_LOSS_ERROR	BRN_ERROR	BRP_ERROR	VR_GOOD_ERROR	OVERTEMP_ERROR	CRC_ERROR	0x0000	R	
0x084	CRC_VALUE_L	[15:8] [7:0]	RESERVED[7:0] CRC_VALUE_L									0x0000	R
0x085	CRC_VALUE_H	[15:8] [7:0]	RESERVED[7:0] CRC_VALUE_H									0x0000	R
0x086	RM_CRC_ENABLE	[15:8] [7:0]	RESERVED[14:7] RESERVED[6:0]								RM_CRC_ENABLE	0x0000	RW
0x087	RM_CRC_DONE	[15:8] [7:0]	RESERVED[14:7] RESERVED[6:0]								RM_CRC_DONE	0x0000	R
0x088	RM_CRC_VALUE_L	[15:8] [7:0]	RESERVED[7:0] RM_CRC_VALUE_L									0x0000	R
0x089	RM_CRC_VALUE_H	[15:8] [7:0]	RESERVED[7:0] RM_CRC_VALUE_H									0x0000	R
0x100	LNA_GAIN	[15:8] [7:0]	LNA4_GAIN		LNA3_GAIN		LNA2_GAIN		LNA1_GAIN		0x0000	RW	
0x101	PGA_GAIN	[15:8] [7:0]	PGA4_GAIN		PGA3_GAIN		PGA2_GAIN		PGA1_GAIN		0x0000	RW	
0x102	ADC_ROUTING1_4	[15:8] [7:0]	RESERVED	ADC4_SRC			RESERVED	ADC3_SRC			0x2222	RW	
			RESERVED	ADC2_SRC			RESERVED	ADC1_SRC					
0x140	DECIM_RATE	[15:8] [7:0]	RESERVED[12:5] RESERVED[4:0]				DECIM_RATE				0x0003	RW	
0x141	HIGH_PASS	[15:8] [7:0]	RESERVED [0]	PHASE_EQ	RESERVED[8:1] HP_SHIFT				ENABLE_HP		0x0018	RW	

Reg	Name	Bits	Bit 7	Bit 6	Bit 5	Bit 4	Bit 3	Bit 2	Bit 1	Bit 0	Reset	RW		
0x143	ACK_MODE	[15:8]	RESERVED[1:0]				ACK_CYCLES		ACK_OUT_RATE		ACK_MODE	0x0000	RW	
		[7:0]												
0x144	TRUNCATE_MODE	[15:8]	RESERVED[13:6]										0x0002	RW
		[7:0]	RESERVED[5:0]							TRUNC_MODE				
0x1C0	SERIAL_MODE	[15:8]	RESERVED										0x0000	RW
		[7:0]	RESERVED	CLK_SRC	LRCLK_MODE	LRCLK_POL	BCLK_POL	DATA_FMT	TDM_MODE					
0x1C1	PARALLEL_MODE	[15:8]	RESERVED[12:5]										0x0000	RW
		[7:0]	RESERVED[4:0]						PAR_NIBBLE	PAR_ENDIAN	PAR_CHANNELS			
0x1C2	OUTPUT_MODE	[15:8]	RESERVED[13:6]										0x0000	RW
		[7:0]	RESERVED[5:0]							CS_OVERRIDE	OUTPUT_MODE			
0x200	ADC_READ0	[15:8]	RESERVED[5:0]										0x0000	R
		[7:0]	ADC_VALUE[7:0]											
0x201	ADC_READ1	[15:8]	RESERVED[5:0]										0x0000	R
		[7:0]	ADC_VALUE[7:0]											
0x210	ADC_SPEED	[15:8]	RESERVED[13:6]										0x0000	RW
		[7:0]	RESERVED[5:0]							ADC_SPEED				
0x211	ADC_MODE	[15:8]	RESERVED[12:5]										0x0000	RW
		[7:0]	RESERVED[4:0]						AUX_INPUT_SEL		AUX_ADC_MODE			
0x250	MP0_MODE	[15:8]	RESERVED[8:1]										0x0000	RW
		[7:0]	RESERVED[0]	DEBOUNCE_VALUE						MP_MODE				
0x251	MP1_MODE	[15:8]	RESERVED[8:1]										0x0000	RW
		[7:0]	RESERVED[0]	DEBOUNCE_VALUE						MP_MODE				
0x260	MP0_WRITE	[15:8]	RESERVED[14:7]										0x0000	RW
		[7:0]	RESERVED[6:0]							MP_REG_WRITE				
0x261	MP1_WRITE	[15:8]	RESERVED[14:7]										0x0000	RW
		[7:0]	RESERVED[6:0]							MP_REG_WRITE				
0x270	MP0_READ	[15:8]	RESERVED[14:7]										0x0000	R
		[7:0]	RESERVED[6:0]							MP_REG_READ				
0x271	MP1_READ	[15:8]	RESERVED[14:7]										0x0000	R
		[7:0]	RESERVED[6:0]							MP_REG_READ				
0x280	SPI_CLK_PIN	[15:8]	RESERVED[12:5]										0x0000	RW
		[7:0]	RESERVED[4:0]				SPI_CLK_PULL		SPI_CLK_DRIVE					
0x281	MISO_PIN	[15:8]	RESERVED[12:5]										0x0000	RW
		[7:0]	RESERVED[4:0]				MISO_PULL		MISO_DRIVE					
0x282	SS_PIN	[15:8]	RESERVED[12:5]										0x0004	RW
		[7:0]	RESERVED[4:0]				SS_PULL		SS_DRIVE					
0x283	MOSI_PIN	[15:8]	RESERVED[12:5]										0x0000	RW
		[7:0]	RESERVED[4:0]				MOSI_PULL		MOSI_DRIVE					
0x284	ADDR15_PIN	[15:8]	RESERVED[12:5]										0x0000	RW
		[7:0]	RESERVED[4:0]				ADDR15_PULL		ADDR15_DRIVE					
0x285	FAULT_PIN	[15:8]	RESERVED[12:5]										0x0004	RW
		[7:0]	RESERVED[4:0]				FAULT_PULL		FAULT_DRIVE					
0x286	FS_ADC_PIN	[15:8]	RESERVED[12:5]										0x0000	RW
		[7:0]	RESERVED[4:0]				FS_ADC_PULL		FS_ADC_DRIVE					
0x287	CS_PIN	[15:8]	RESERVED[12:5]										0x0004	RW
		[7:0]	RESERVED[4:0]				CS_PULL		CS_DRIVE					
0x288	SCLK_ADC_PIN	[15:8]	RESERVED[12:5]										0x0000	RW
		[7:0]	RESERVED[4:0]				SCLK_ADC_PULL		SCLK_ADC_DRIVE					
0x289	ADC_DOUT0_PIN	[15:8]	RESERVED[12:5]										0x0000	RW
		[7:0]	RESERVED[4:0]						ADC_DOUT_PULL	ADC_DOUT_DRIVE				

Reg	Name	Bits	Bit 7	Bit 6	Bit 5	Bit 4	Bit 3	Bit 2	Bit 1	Bit 0	Reset	RW	
0x28A	ADC_DOUT1_PIN	[15:8] [7:0]	RESERVED[12:5]				RESERVED[4:0]		ADC_DOUT_PULL	ADC_DOUT_DRIVE		0x0000	RW
0x28B	ADC_DOUT2_PIN	[15:8] [7:0]	RESERVED[12:5]				RESERVED[4:0]		ADC_DOUT_PULL	ADC_DOUT_DRIVE		0x0000	RW
0x28C	ADC_DOUT3_PIN	[15:8] [7:0]	RESERVED[12:5]				RESERVED[4:0]		ADC_DOUT_PULL	ADC_DOUT_DRIVE		0x0000	RW
0x28D	ADC_DOUT4_PIN	[15:8] [7:0]	RESERVED[12:5]				RESERVED[4:0]		ADC_DOUT_PULL	ADC_DOUT_DRIVE		0x0000	RW
0x28E	ADC_DOUT5_PIN	[15:8] [7:0]	RESERVED[12:5]				RESERVED[4:0]		ADC_DOUT_PULL	ADC_DOUT_DRIVE		0x0000	RW
0x291	DATA_READY_PIN	[15:8] [7:0]	RESERVED[12:5]				RESERVED[4:0]		DATA_READY_PULL	DATA_READY_DRIVE		0x0000	RW
0x292	XTAL_CTRL	[15:8] [7:0]	RESERVED[13:6]				RESERVED[5:0]		XTAL_DRV	XTAL_ENB		0x0000	RW
0x301	ADC_SETTING1	[15:8] [7:0]	RESERVED[15:10]				RESERVED[7:3]		PDETECT_EN	PERFORM_IMPROVE1	EQ_CAP_CTRL RESERVED	0x0304	RW
0x308	ADC_SETTING2	[15:8] [7:0]	RESERVED[8:1]				RESERVED[0]		PERFORM_IMPROVE2			0x0000	RW
0x30A	ADC_SETTING3	[15:8] [7:0]	RESERVED[11:4]				RESERVED[3:0]		PERFORM_IMPROVE5	RESERVED	PERFORM_IMPROVE4	0x0009	RW
0x30E	DEJITTER_WINDOW	[15:8] [7:0]	RESERVED[15:8]				RESERVED[7:4]		DEJITTER			0x0003	RW
0xFD00	CRC_EN	[15:8] [7:0]	RESERVED[14:7]				RESERVED[6:0]		CRC_EN			0x0000	RW

REGISTER DETAILS

CLOCK CONTROL REGISTER

Address: 0x000, Reset: 0x0001, Name: CLK_CTRL

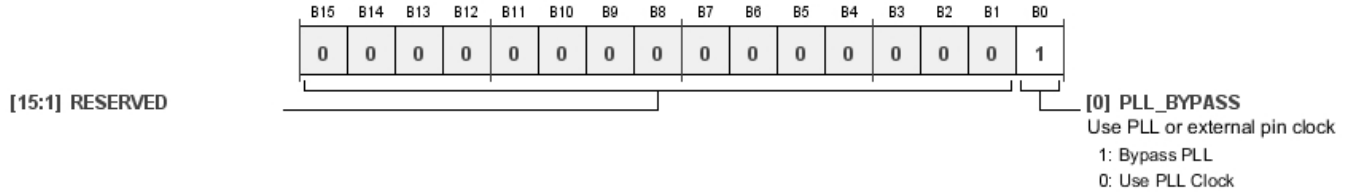

Table 24. Bit Descriptions for CLK_CTRL

Bits	Bit Name	Settings	Description	Reset	Access
0	PLL_BYPASS	1 0	Use PLL or External Pin Clock. Bypass PLL. Use PLL Clock.	0x1	RW

PLL DENOMINATOR REGISTER

Address: 0x001, Reset: 0x0000, Name: PLL_DEN

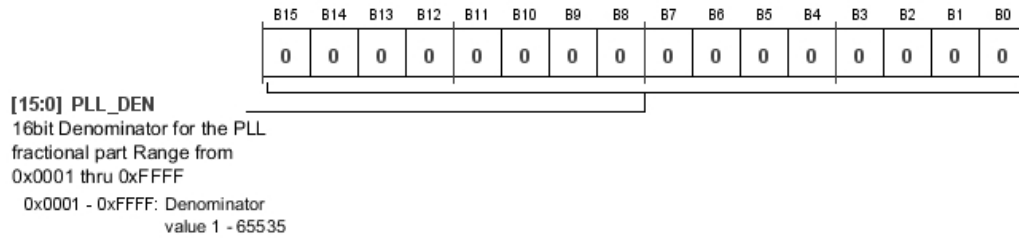

Table 25. Bit Descriptions for PLL_DEN

Bits	Bit Name	Settings	Description	Reset	Access
[15:0]	PLL_DEN	0x0001 to 0xFFFF	16-Bit Denominator for the PLL Fractional Part Range from 0x0001 Through 0xFFFF. Denominator Value 1 to 65,535.	0x0	RW

PLL NUMERATOR REGISTER

Address: 0x002, Reset: 0x0000, Name: PLL_NUM

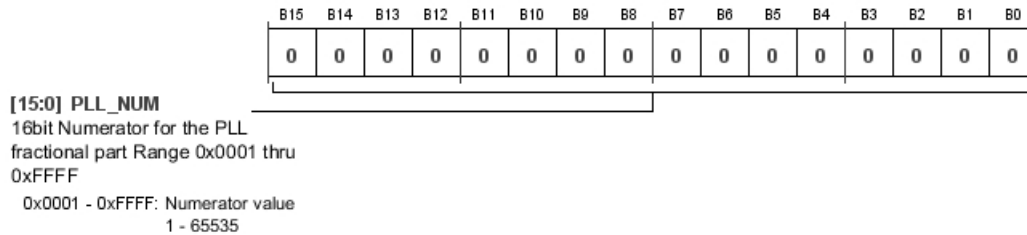

Table 26. Bit Descriptions for PLL_NUM

Bits	Bit Name	Settings	Description	Reset	Access
[15:0]	PLL_NUM	0x0001 to 0xFFFF	16-Bit Numerator for the PLL Fractional Part Range from 0x0001 Through 0xFFFF. Numerator Value 1 to 65,535.	0x0	RW

PLL CONTROL REGISTER

Address: 0x003, Reset: 0x0000, Name: PLL_CTRL

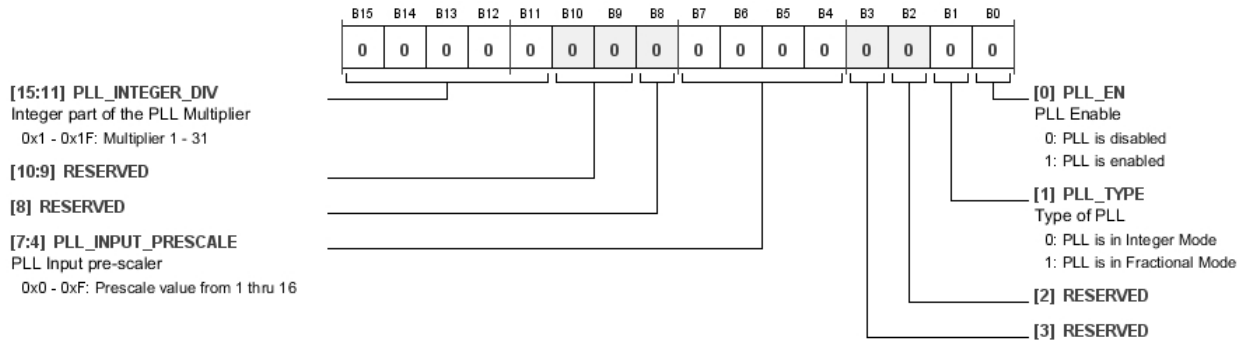

Table 27. Bit Descriptions for PLL_CTRL

Bits	Bit Name	Settings	Description	Reset	Access
[15:11]	PLL_INTEGER_DIV	0x1 to 0x1F	Integer Part of the PLL Multiplier. Multiplier 1 to 31.	0x00	RW
[7:4]	PLL_INPUT_PRESCALE	0x0 to 0xF	PLL Input Prescaler. Prescale Value from 1 Through 16.	0x0	RW
1	PLL_TYPE	0 1	Type of PLL. 0 PLL is in Integer Mode. 1 PLL is in Fractional Mode.	0x0	RW
0	PLL_EN	0 1	PLL Enable. 0 PLL is Disabled. 1 PLL is Enabled.	0x0	RW

PLL STATUS REGISTER

Address: 0x005, Reset: 0x0000, Name: PLL_LOCK

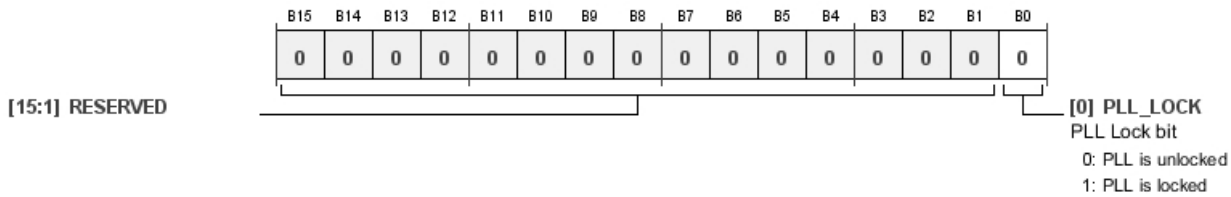

Table 28. Bit Descriptions for PLL_LOCK

Bits	Bit Name	Settings	Description	Reset	Access
0	PLL_LOCK	0 1	PLL Lock Bit. 0 PLL is Unlocked. 1 PLL is Locked.	0x0	R

MASTER ENABLE SWITCH REGISTER

Address: 0x040, Reset: 0x0000, Name: MASTER_ENABLE

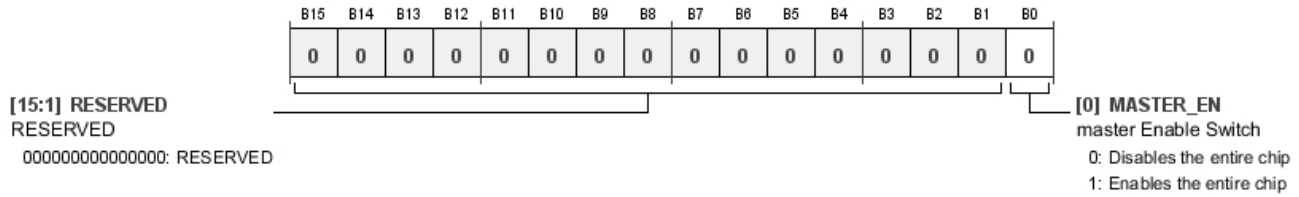

Table 29. Bit Descriptions for MASTER_ENABLE

Bits	Bit Name	Settings	Description	Reset	Access
0	MASTER_EN	0 1	Master Enable Switch. Disables the Entire Chip. Enables the Entire Chip.	0x0	RW

ADC ENABLE REGISTER

Address: 0x041, Reset: 0x00FF, Name: ADC_ENABLE

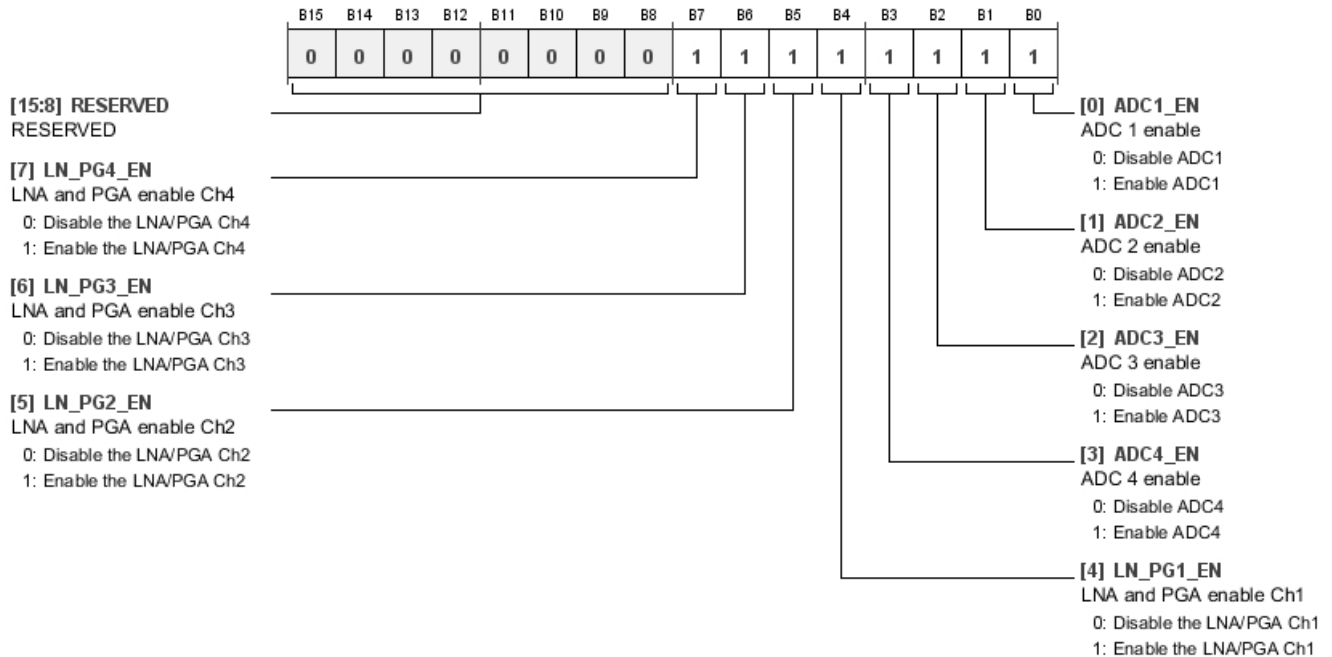

Table 30. Bit Descriptions for ADC_ENABLE

Bits	Bit Name	Settings	Description	Reset	Access
7	LN_PG4_EN	0 1	LNA and PGA Enable Channel 4. Disable the LNA/PGA Channel 4. Enable the LNA/PGA Channel 4.	0x1	RW
6	LN_PG3_EN	0 1	LNA and PGA Enable Channel 3. Disable the LNA/PGA Channel 3. Enable the LNA/PGA Channel 3.	0x1	RW

Bits	Bit Name	Settings	Description	Reset	Access
5	LN_PG2_EN	0 1	LNA and PGA Enable Channel 2. Disable the LNA/PGA Channel 2. Enable the LNA/PGA Channel 2.	0x1	RW
4	LN_PG1_EN	0 1	LNA and PGA Enable Channel 1. Disable the LNA/PGA Channel 1. Enable the LNA/PGA Channel 1.	0x1	RW
3	ADC4_EN	0 1	ADC 4 Enable. Disable ADC 4. Enable ADC 4.	0x1	RW
2	ADC3_EN	0 1	ADC 3 Enable. Disable ADC 3. Enable ADC 3.	0x1	RW
1	ADC2_EN	0 1	ADC 2 Enable. Disable ADC 2. Enable ADC 2.	0x1	RW
0	ADC1_EN	0 1	ADC 1 Enable. Disable ADC 1. Enable ADC 1.	0x1	RW

POWER ENABLE REGISTER

Address: 0x042, Reset: 0x03FF, Name: POWER_ENABLE

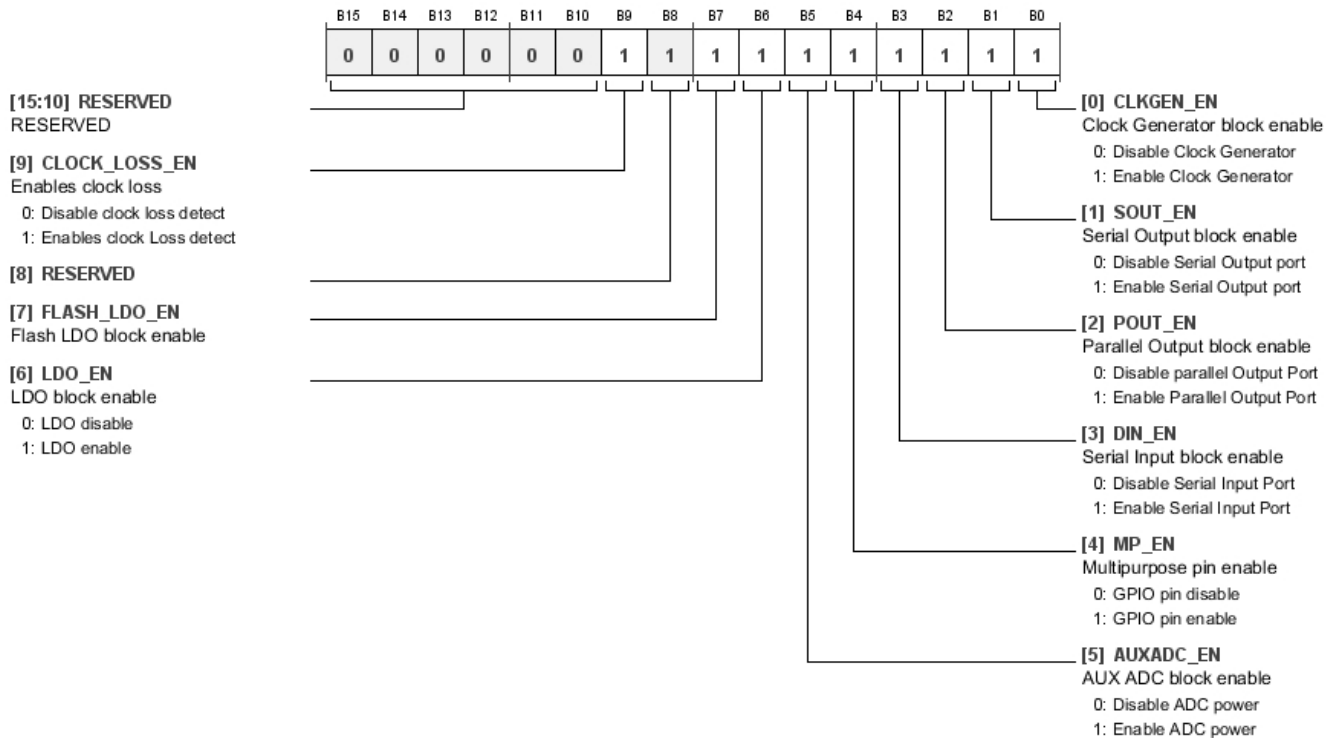

Table 31. Bit Descriptions for POWER_ENABLE

Bits	Bit Name	Settings	Description	Reset	Access
9	CLOCK_LOSS_EN	0 1	Enables Clock Loss. Disables Clock Loss Detect. Enables Clock Loss Detect.	0x1	RW
7	FLASH_LDO_EN		Flash LDO Block Enable.	0x1	RW

Bits	Bit Name	Settings	Description	Reset	Access
6	LDO_EN	0 1	LDO Block Enable. LDO Disable. LDO Enable.	0x1	RW
5	AUXADC_EN	0 1	AUX ADC Block Enable. Disable ADC Power. Enable ADC Power.	0x1	RW
4	MP_EN	0 1	Multipurpose Pin Enable. GPIO Pin Disable. GPIO Pin Enable.	0x1	RW
3	DIN_EN	0 1	Serial Input Block Enable. Disable Serial Input Port. Enable Serial Input Port.	0x1	RW
2	POUT_EN	0 1	Parallel Output Block Enable. Disable Parallel Output Port. Enable Parallel Output Port.	0x1	RW
1	SOUT_EN	0 1	Serial Output Block Enable. Disable Serial Output Port. Enable Serial Output Port.	0x1	RW
0	CLKGEN_EN	0 1	Clock Generator Block Enable. Disable Clock Generator. Enable Clock Generator.	0x1	RW

CLEAR THE ASIL ERRORS REGISTER

Address: 0x080, Reset: 0x0000, Name: ASIL_CLEAR

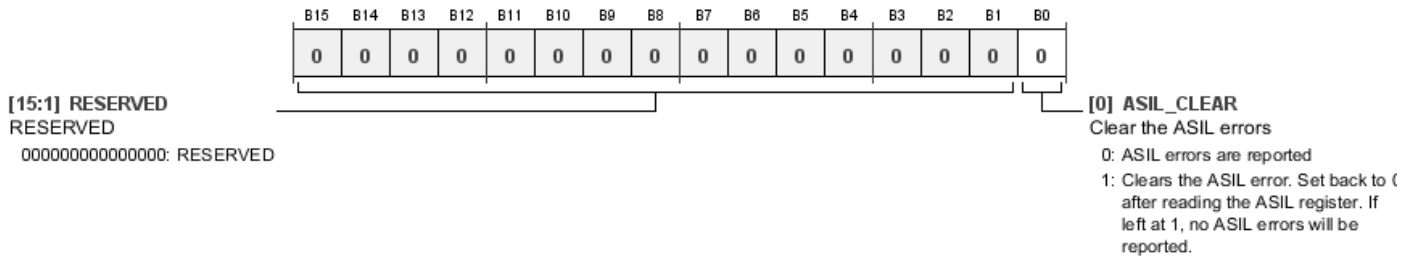

[0] ASIL_CLEAR
 Clear the ASIL errors
 0: ASIL errors are reported
 1: Clears the ASIL error. Set back to 0 after reading the ASIL register. If left at 1, no ASIL errors will be reported.

Table 32. Bit Descriptions for ASIL_CLEAR

Bits	Bit Name	Settings	Description	Reset	Access
0	ASIL_CLEAR	0 1	Clear the Automotive Safety Integrity Level (ASIL) Errors. ASIL Errors are Reported. Clears the ASIL Error. Set back to 0 after reading the ASIL register. If left at 1, no ASIL errors are reported.	0x0	RW

SELECTS WHICH ERRORS TO MASK REGISTER

Address: 0x081, Reset: 0x0000, Name: ASIL_MASK

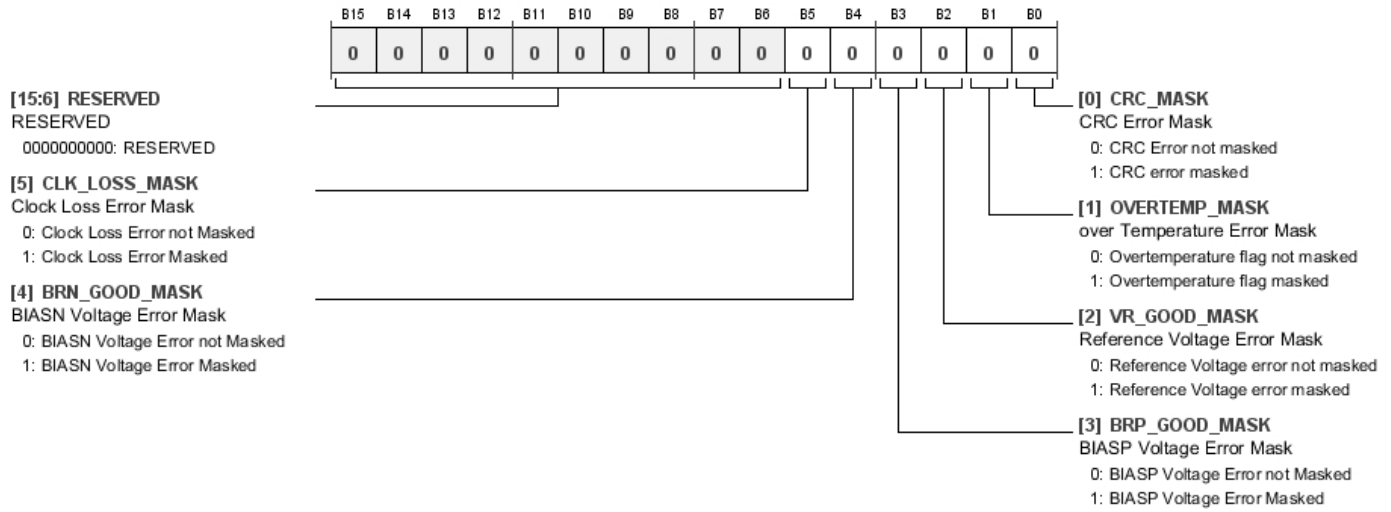

Table 33. Bit Descriptions for ASIL_MASK

Bits	Bit Name	Settings	Description	Reset	Access
5	CLK_LOSS_MASK	0 1	Clock Loss Error Mask. Clock Loss Error Not Masked. Clock Loss Error Masked.	0x0	RW
4	BRN_GOOD_MASK	0 1	BIASN Voltage Error Mask. BIASN Voltage Error Not Masked. BIASN Voltage Error Masked.	0x0	RW
3	BRP_GOOD_MASK	0 1	BIASP Voltage Error Mask. BIASP Voltage Error Not Masked. BIASP Voltage Error Masked.	0x0	RW
2	VR_GOOD_MASK	0 1	Reference Voltage Error Mask. Reference Voltage Error Not Masked. Reference Voltage Error Masked.	0x0	RW
1	OVERTEMP_MASK	0 1	Overtemperature Error Mask. Overtemperature Flag Not Masked. Overtemperature Flag Masked.	0x0	RW
0	CRC_MASK	0 1	CRC Error Mask. CRC Error Not Masked. CRC Error Masked.	0x0	RW

ASIL ERROR FLAG REGISTER

Address: 0x082, Reset: 0x0000, Name: ASIL_FLAG

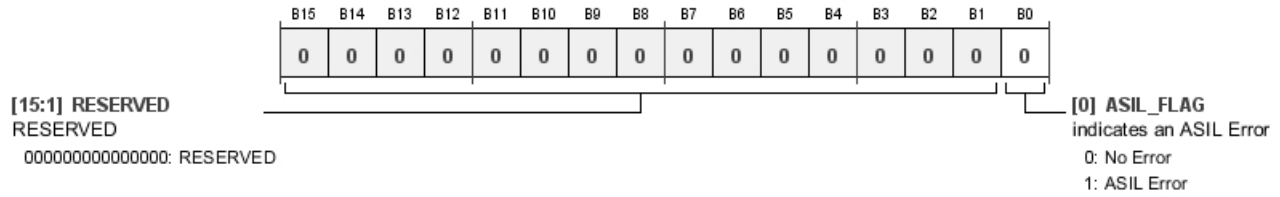

Table 34. Bit Descriptions for ASIL_FLAG

Bits	Bit Name	Settings	Description	Reset	Access
0	ASIL_FLAG	0 1	Indicates an ASIL Error. No Error. ASIL Error.	0x0	R

ASIL ERROR CODE REGISTER

Address: 0x083, Reset: 0x0000, Name: ASIL_ERROR

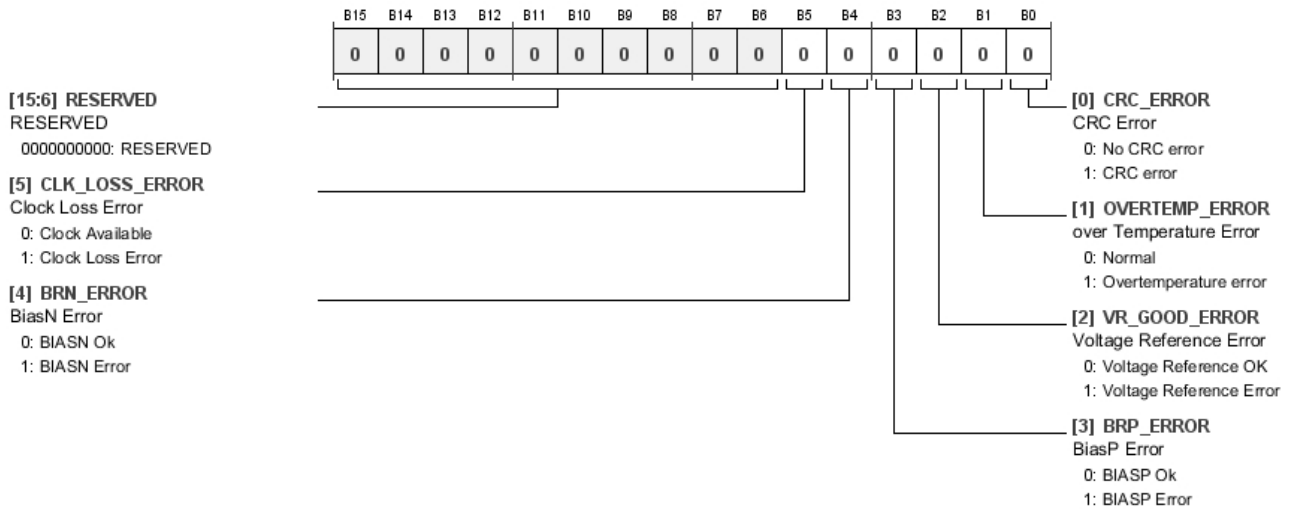

Table 35. Bit Descriptions for ASIL_ERROR

Bits	Bit Name	Settings	Description	Reset	Access
5	CLK_LOSS_ERROR	0 1	Clock Loss Error. Clock Available. Clock Loss Error.	0x0	R
4	BRN_ERROR	0 1	BIASN Error. BIASN OK. BIASN Error.	0x0	R
3	BRP_ERROR	0 1	BIASP Error. BIASP OK. BIASP Error.	0x0	R
2	VR_GOOD_ERROR	0 1	Voltage Reference Error. Voltage Reference OK. Voltage Reference Error.	0x0	R

Bits	Bit Name	Settings	Description	Reset	Access
1	OVERTEMP_ERROR	0 1	Overtemperature Error. Normal. Overtemperature Error.	0x0	R
0	CRC_ERROR	0 1	CRC Error. No CRC Error. CRC Error.	0x0	R

CRC VALUE, BITS[7:0] REGISTER

Address: 0x084, Reset: 0x0000, Name: CRC_VALUE_L

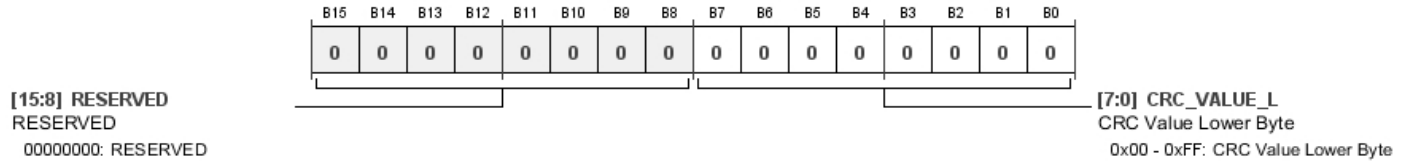

Table 36. Bit Descriptions for CRC_VALUE_L

Bits	Bit Name	Settings	Description	Reset	Access
[7:0]	CRC_VALUE_L	0x00 to 0xFF	CRC Value Lower Byte. CRC Value Lower Byte.	0x0	R

CRC VALUE REGISTER

Address: 0x085, Reset: 0x0000, Name: CRC_VALUE_H

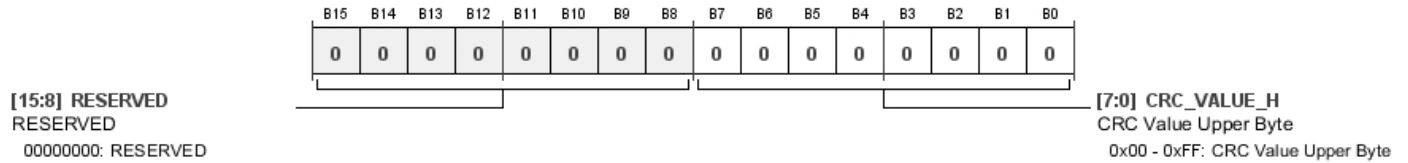

Table 37. Bit Descriptions for CRC_VALUE_H

Bits	Bit Name	Settings	Description	Reset	Access
[7:0]	CRC_VALUE_H	0x00 to 0xFF	CRC Value Upper Byte. CRC Value Upper Byte.	0x0	R

START CALCULATING THE CRC VALUE OF THE REGISTER MAP CONTENT REGISTER

Address: 0x086, Reset: 0x0000, Name: RM_CRC_ENABLE

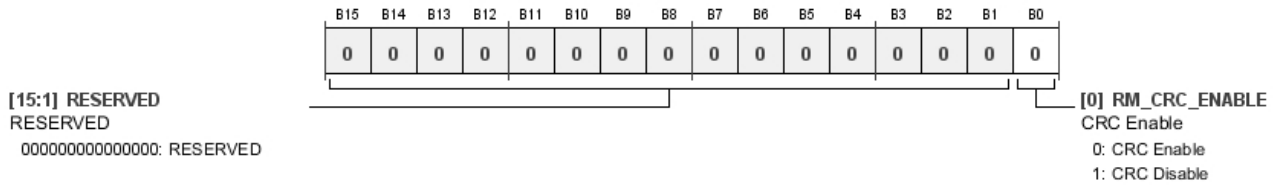

Table 38. Bit Descriptions for RM_CRC_ENABLE

Bits	Bit Name	Settings	Description	Reset	Access
0	RM_CRC_ENABLE	0 1	CRC Enable. CRC Enable. CRC Disable.	0x0	RW

REGISTER MAP CRC CALCULATION DONE REGISTER

Address: 0x087, Reset: 0x0000, Name: RM_CRC_DONE

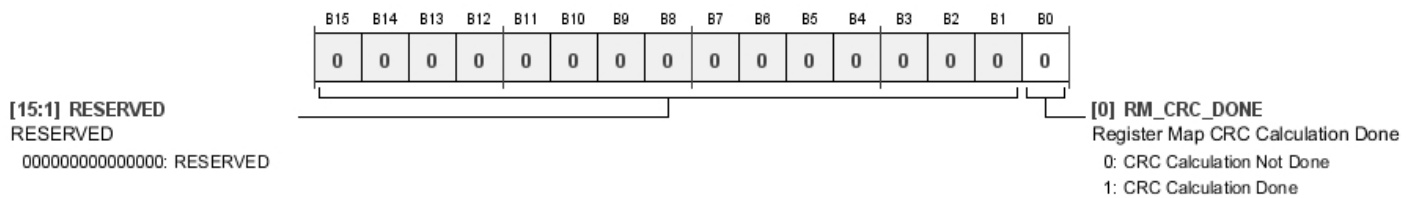

Table 39. Bit Descriptions for RM_CRC_DONE

Bits	Bit Name	Settings	Description	Reset	Access
0	RM_CRC_DONE	0 1	Register Map CRC Calculation Done. CRC Calculation Not Done. CRC Calculation Done.	0x0	R

REGISTER MAP CRC VALUE, BITS[7:0] REGISTER

Address: 0x088, Reset: 0x0000, Name: RM_CRC_VALUE_L

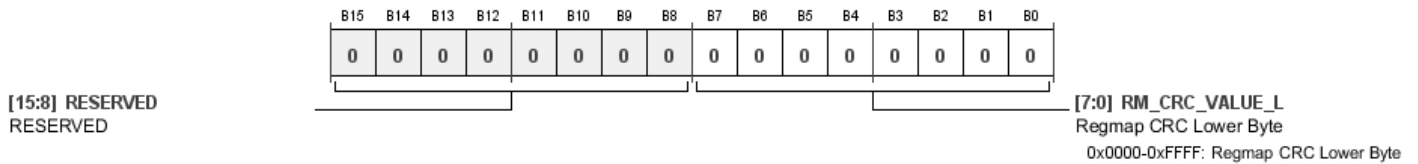

Table 40. Bit Descriptions for RM_CRC_VALUE_L

Bits	Bit Name	Settings	Description	Reset	Access
[7:0]	RM_CRC_VALUE_L	0x0000 to 0xFFFF	Regmap CRC Lower Byte.	0x0	R

REGISTER MAP CRC VALUE, BITS[15:8] REGISTER

Address: 0x089, Reset: 0x0000, Name: RM_CRC_VALUE_H

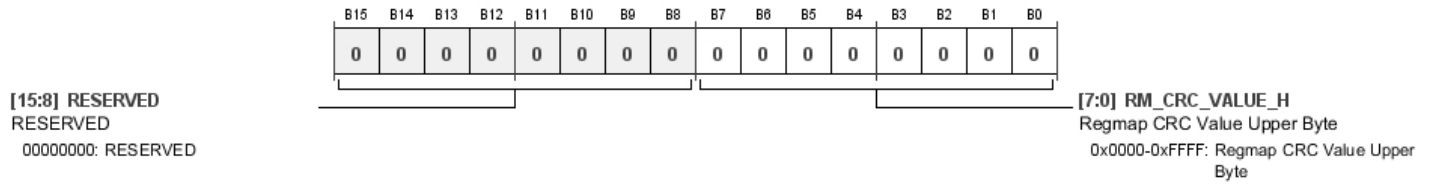

Table 41. Bit Descriptions for RM_CRC_VALUE_H

Bits	Bit Name	Settings	Description	Reset	Access
[7:0]	RM_CRC_VALUE_H	0x0000 to 0xFFFF	Regmap CRC Value Upper Byte. Regmap CRC Value Upper Byte.	0x0	R

LOW NOISE AMPLIFIER GAIN CONTROL REGISTER

Address: 0x100, Reset: 0x0000, Name: LNA_GAIN

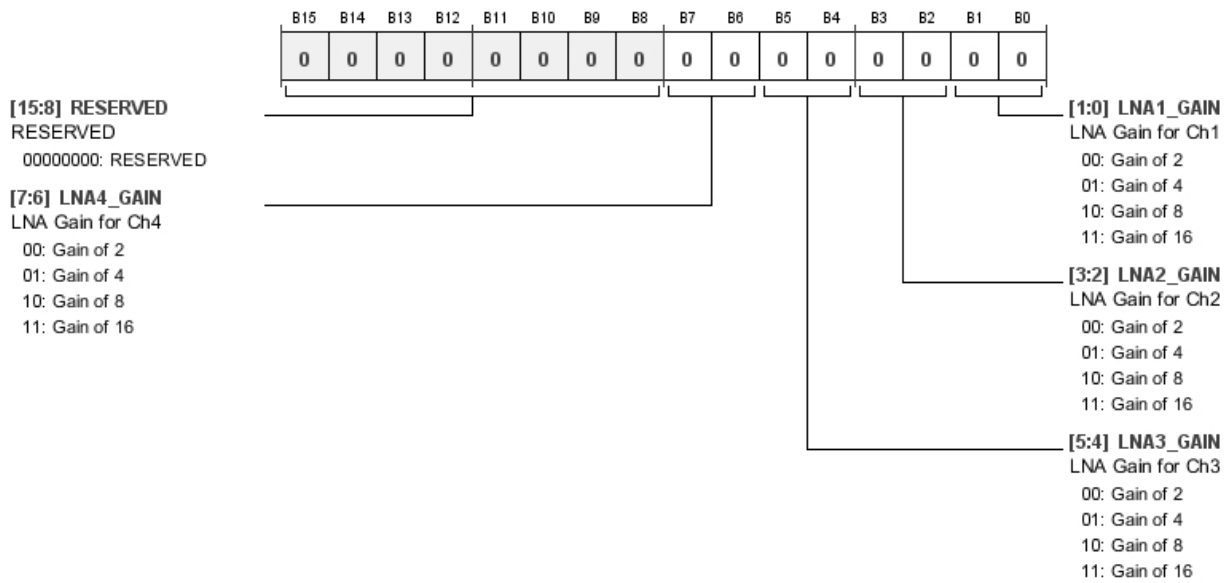

Table 42. Bit Descriptions for LNA_GAIN

Bits	Bit Name	Settings	Description	Reset	Access
[7:6]	LNA4_GAIN	00 01 10 11	LNA Gain for Channel 4. Gain of 2. Gain of 4. Gain of 8. Gain of 16.	0x0	RW
[5:4]	LNA3_GAIN	00 01 10 11	LNA Gain for Channel 3. Gain of 2. Gain of 4. Gain of 8. Gain of 16.	0x0	RW

Bits	Bit Name	Settings	Description	Reset	Access
[3:2]	LNA2_GAIN	00 01 10 11	LNA Gain for Channel 2. Gain of 2. Gain of 4. Gain of 8. Gain of 16.	0x0	RW
[1:0]	LNA1_GAIN	00 01 10 11	LNA Gain for Channel 1. Gain of 2. Gain of 4. Gain of 8. Gain of 16.	0x0	RW

PROGRAMMABLE GAIN AMPLIFIER GAIN CONTROL REGISTER

Address: 0x101, Reset: 0x0000, Name: PGA_GAIN

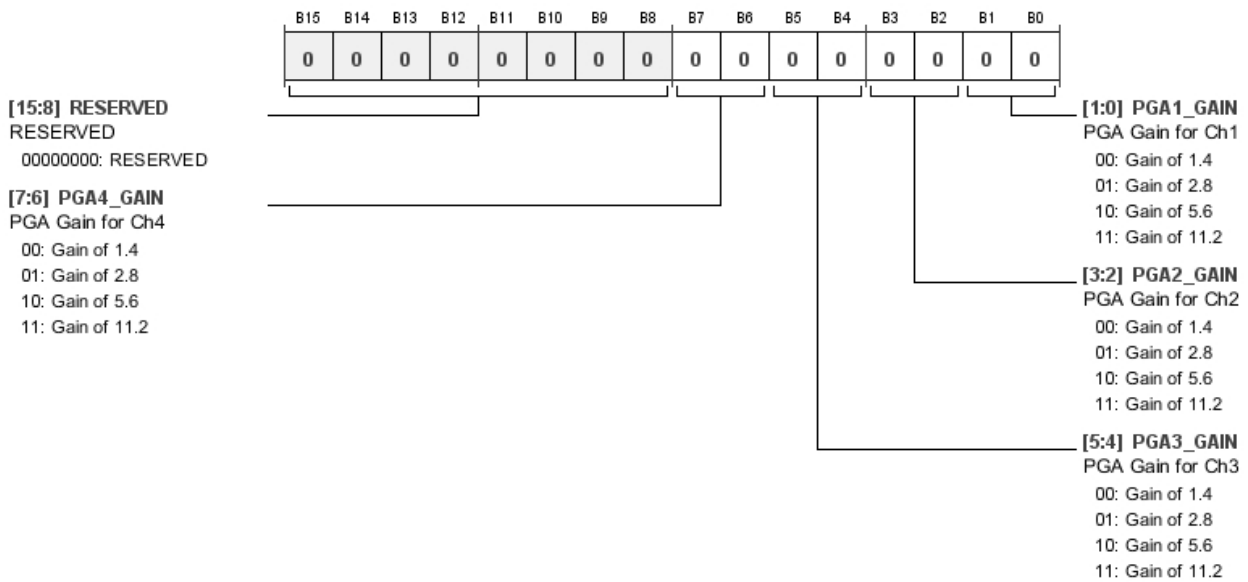

Table 43. Bit Descriptions for PGA_GAIN

Bits	Bit Name	Settings	Description	Reset	Access
[7:6]	PGA4_GAIN	00 01 10 11	PGA Gain for Channel 4. Gain of 1.4. Gain of 2.8. Gain of 5.6. Gain of 11.2.	0x0	RW
[5:4]	PGA3_GAIN	00 01 10 11	PGA Gain for Channel 3. Gain of 1.4. Gain of 2.8. Gain of 5.6. Gain of 11.2.	0x0	RW
[3:2]	PGA2_GAIN	00 01 10 11	PGA Gain for Channel 2. Gain of 1.4. Gain of 2.8. Gain of 5.6. Gain of 11.2.	0x0	RW

Bits	Bit Name	Settings	Description	Reset	Access
[1:0]	PGA1_GAIN	00 01 10 11	PGA Gain for Channel 1. Gain of 1.4. Gain of 2.8. Gain of 5.6. Gain of 11.2.	0x0	RW

SIGNAL PATH FOR ADC 1 THROUGH ADC 4 REGISTER

Address: 0x102, Reset: 0x2222, Name: ADC_ROUTING1_4

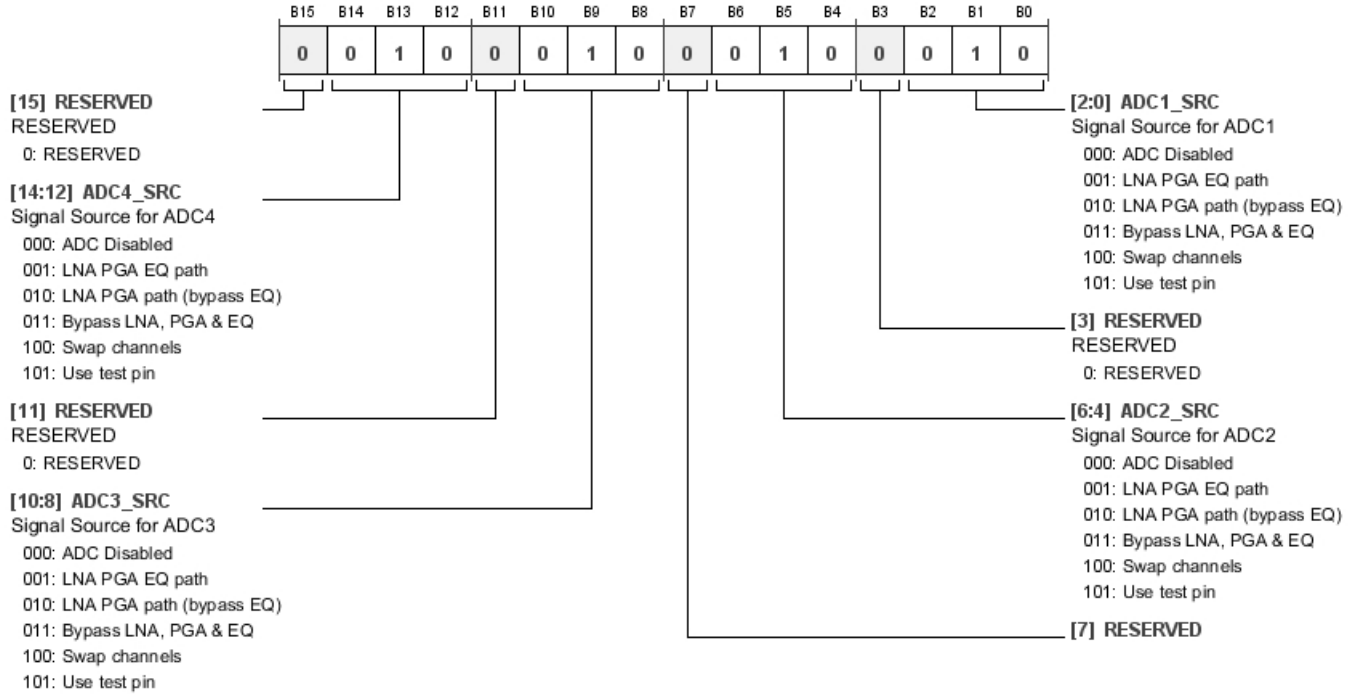

Table 44. Bit Descriptions for ADC_ROUTING1_4

Bits	Bit Name	Settings	Description	Reset	Access
[14:12]	ADC4_SRC	000 001 010 011 100 101	Signal Source for ADC4. ADC Disabled. LNA PGA EQ Path. LNA PGA Path (Bypass EQ). Bypass LNA, PGA, and EQ. Swap Channels. Use Test Pin.	0x2	RW
[10:8]	ADC3_SRC	000 001 010 011 100 101	Signal Source for ADC3. ADC Disabled. LNA PGA EQ Path. LNA PGA Path (Bypass EQ). Bypass LNA, PGA, and EQ. Swap Channels. Use Test Pin.	0x2	RW

Bits	Bit Name	Settings	Description	Reset	Access
[6:4]	ADC2_SRC	000 ADC Disabled. 001 LNA PGA EQ Path. 010 LNA PGA Path (Bypass EQ). 011 Bypass LNA, PGA, and EQ. 100 Swap Channels. 101 Use Test Pin.	Signal Source for ADC2.	0x2	RW
[2:0]	ADC1_SRC	000 ADC Disabled. 001 LNA PGA EQ Path. 010 LNA PGA Path (Bypass EQ). 011 Bypass LNA, PGA, and EQ. 100 Swap Channels. 101 Use Test Pin.	Signal Source for ADC1.	0x2	RW

DECIMATOR RATE CONTROL REGISTER

Address: 0x140, Reset: 0x0003, Name: DECIM_RATE

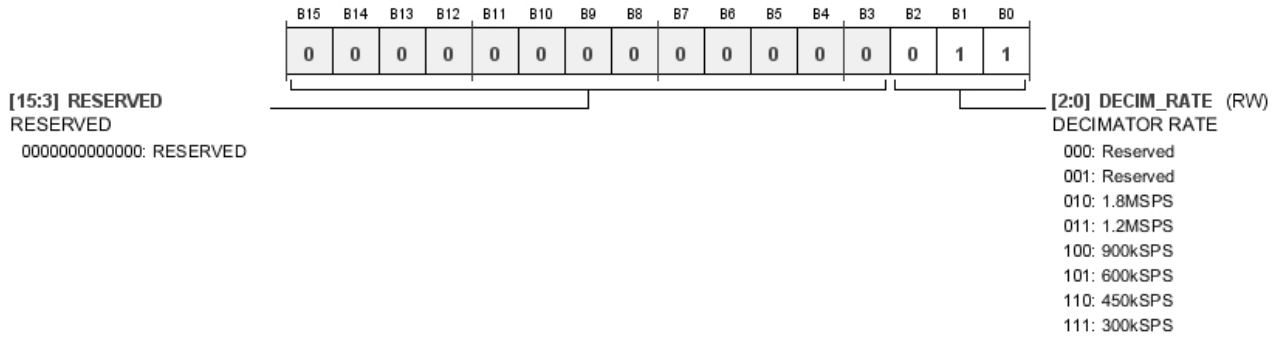

Table 45. Bit Descriptions for DECIM_RATE

Bits	Bit Name	Settings	Description	Reset	Access
[2:0]	DECIM_RATE	000 Reserved. 001 Reserved. 010 1.8 MSPS. 011 1.2 MSPS. 100 900 kSPS. 101 600 kSPS. 110 450 kSPS. 111 300 kSPS.	Decimator Rate.	0x3	RW

HIGH PASS FILTER CONTROL REGISTER

Address: 0x141, Reset: 0x0018, Name: HIGH_PASS

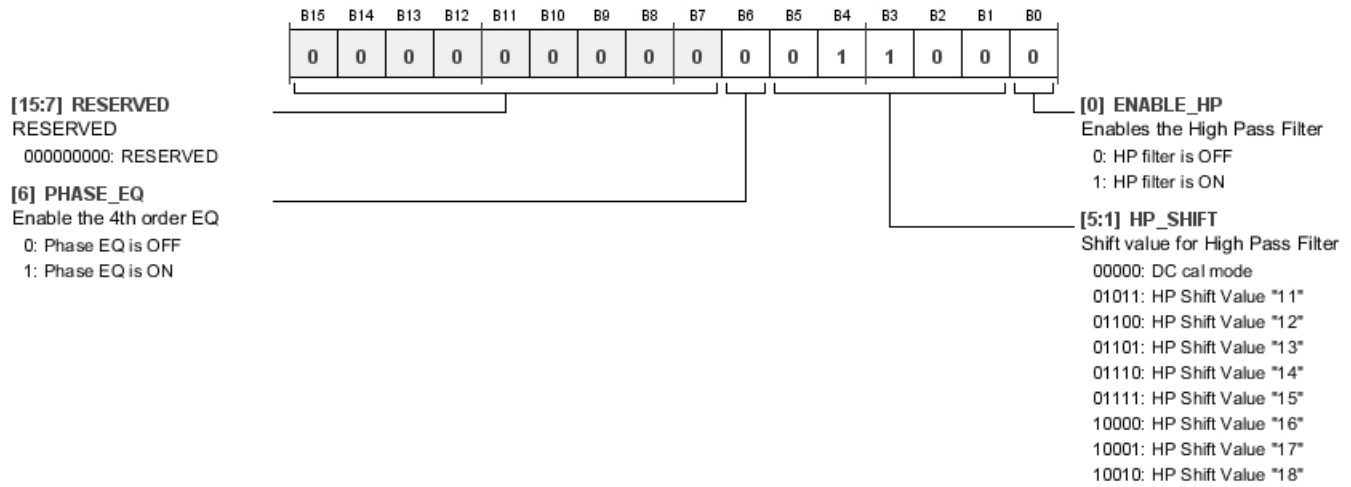

Table 46. Bit Descriptions for HIGH_PASS

Bits	Bit Name	Settings	Description	Reset	Access
6	PHASE_EQ	0 1	Enable the 4 th -Order EQ. Phase EQ is Off. Phase EQ is On.	0x0	RW
[5:1]	HP_SHIFT	00000 01011 01100 01101 01110 01111 10000 10001 10010	Shift Value for High-Pass Filter. DC Cal Mode. HP Shift Value 11. HP Shift Value 12. HP Shift Value 13. HP Shift Value 14. HP Shift Value 15. HP Shift Value 16. HP Shift Value 17. HP Shift Value 18.	0x0C	RW
0	ENABLE_HP	0 1	Enables the High-Pass Filter. HP Filter is Off. HP Filter is On.	0x0	RW

DAQ MODE CONTROL REGISTER

Address: 0x143, Reset: 0x0000, Name: ACK_MODE

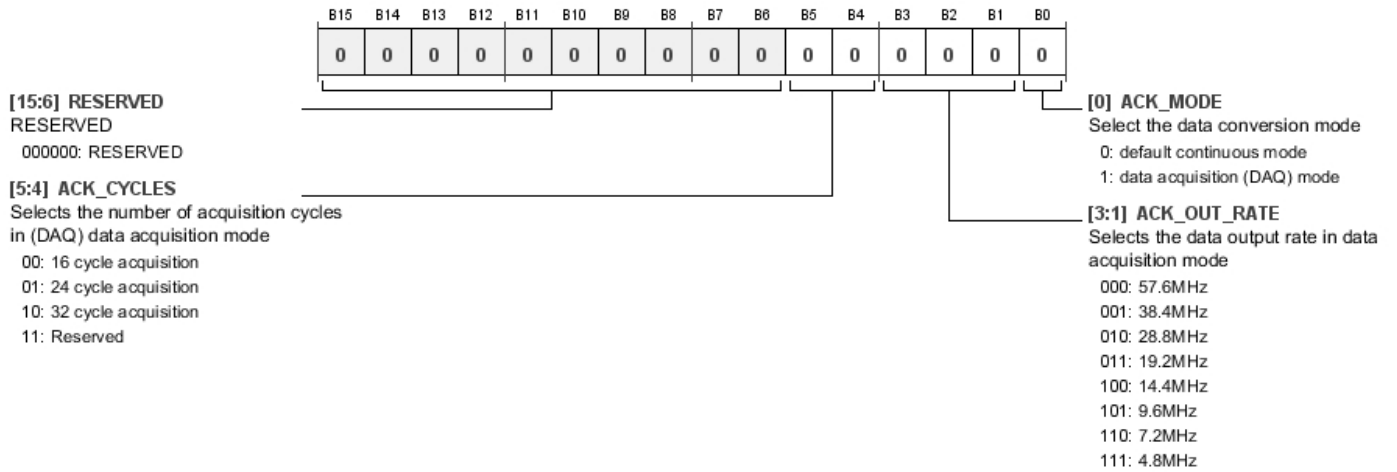

Table 47. Bit Descriptions for ACK_MODE

Bits	Bit Name	Settings	Description	Reset	Access
[5:4]	ACK_CYCLES	00 01 10 11	Selects the Number of Acquisition Cycles in DAQ Mode. 16-Cycle Acquisition. 24-Cycle Acquisition. 32-Cycle Acquisition. Reserved.	0x0	RW
[3:1]	ACK_OUT_RATE	000 001 010 011 100 101 110 111	Selects the Data Output Rate in DAQ Mode. 57.6 MHz. 38.4 MHz. 28.8 MHz. 19.2 MHz. 14.4 MHz. 9.6 MHz. 7.2 MHz. 4.8 MHz.	0x0	RW
0	ACK_MODE	0 1	Selects the Data Conversion Mode. Default Continuous Mode. DAQ Mode.	0x0	RW

DECIMATOR TRUNCATE CONTROL REGISTER

Address: 0x144, Reset: 0x0002, Name: TRUNCATE_MODE

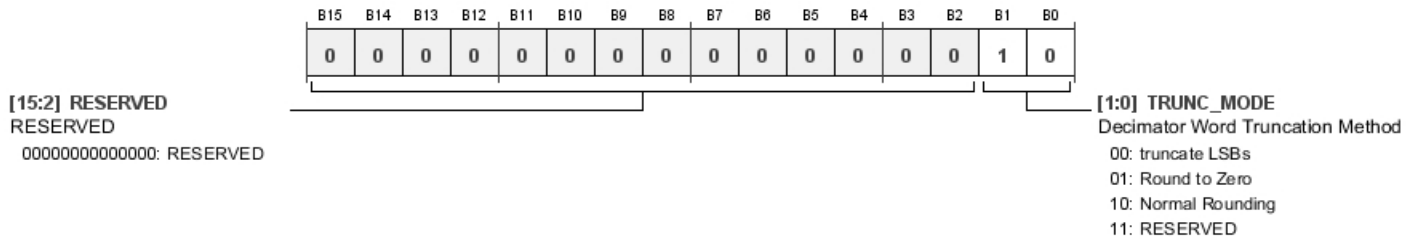

Table 48. Bit Descriptions for TRUNCATE_MODE

Bits	Bit Name	Settings	Description	Reset	Access
[1:0]	TRUNC_MODE		Decimator Word Truncation Method.	0x2	RW
		00	Truncate LSBs.		
		01	Round to Zero.		
		10	Normal Rounding.		
		11	Reserved.		

SERIAL OUTPUT PORT CONTROL REGISTER

Address: 0x1C0, Reset: 0x0000, Name: SERIAL_MODE

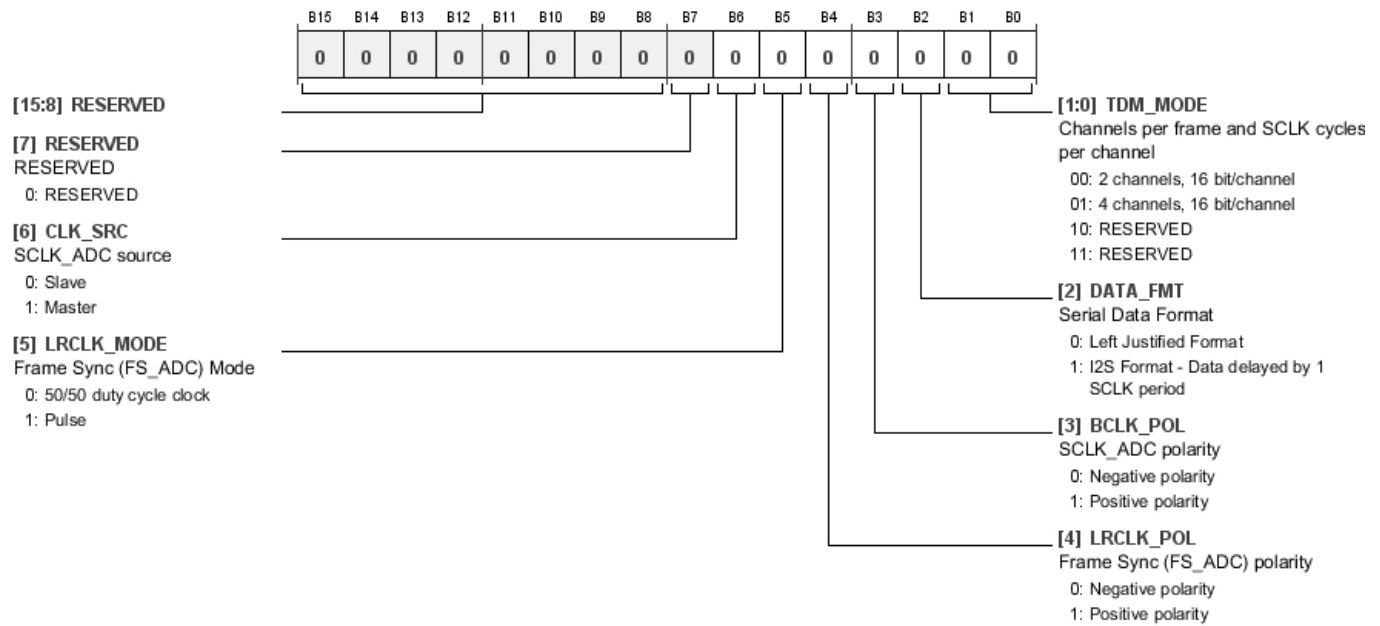

Table 49. Bit Descriptions for SERIAL_MODE

Bits	Bit Name	Settings	Description	Reset	Access
6	CLK_SRC		SCLK_ADC Source.	0x0	RW
		0	Slave.		
		1	Master.		
5	LRCLK_MODE		Frame Sync (FS_ADC) Mode.	0x0	RW
		0	50/50 Duty Cycle Clock.		
		1	Pulse.		

Bits	Bit Name	Settings	Description	Reset	Access
4	LRCLK_POL	0 1	Frame Sync (FS_ADC) Polarity. Negative Polarity. Positive Polarity.	0x0	RW
3	BCLK_POL	0 1	SCLK_ADC Polarity. Negative Polarity. Positive Polarity.	0x0	RW
2	DATA_FMT	0 1	Serial Data Format. Left Justified Format. I2S Format—Data Delayed by 1 SCLK Period.	0x0	RW
[1:0]	TDM_MODE	00 01 10 11	Channels per Frame and SCLK Cycles per Channel. 2 Channels, 16 Bits per Channel. 4 Channels, 16 Bits per Channel. Reserved. Reserved.	0x0	RW

PARALLEL PORT CONTROL REGISTER

Address: 0x1C1, Reset: 0x0000, Name: PARALLEL_MODE

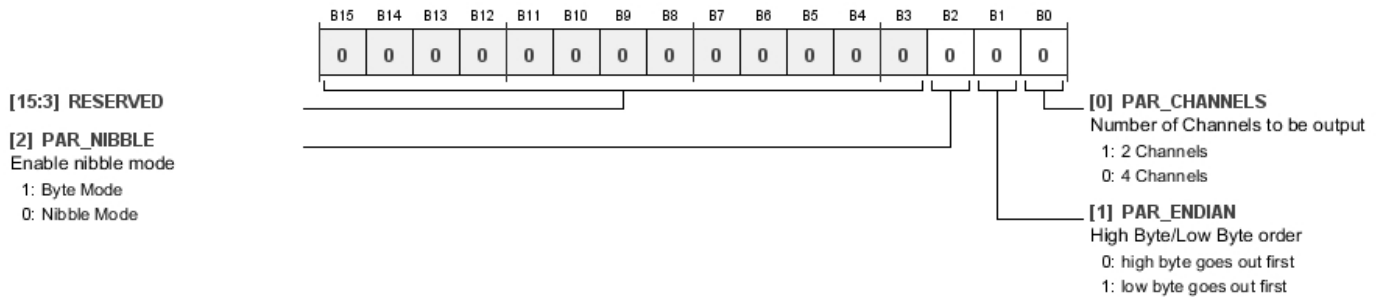

Table 50. Bit Descriptions for PARALLEL_MODE

Bits	Bit Name	Settings	Description	Reset	Access
2	PAR_NIBBLE	1 0	Enable Nibble Mode. Byte Mode. Nibble Mode.	0x0	RW
1	PAR_ENDIAN	0 1	High Byte/Low Byte Order. High Byte Goes Out First. Low Byte Goes Out First.	0x0	RW
0	PAR_CHANNELS	1 0	Number of Channels to be Output. 2 Channels. 4 Channels.	0x0	RW

ADC DIGITAL OUTPUT MODE REGISTER

Address: 0x1C2, Reset: 0x0000, Name: OUTPUT_MODE

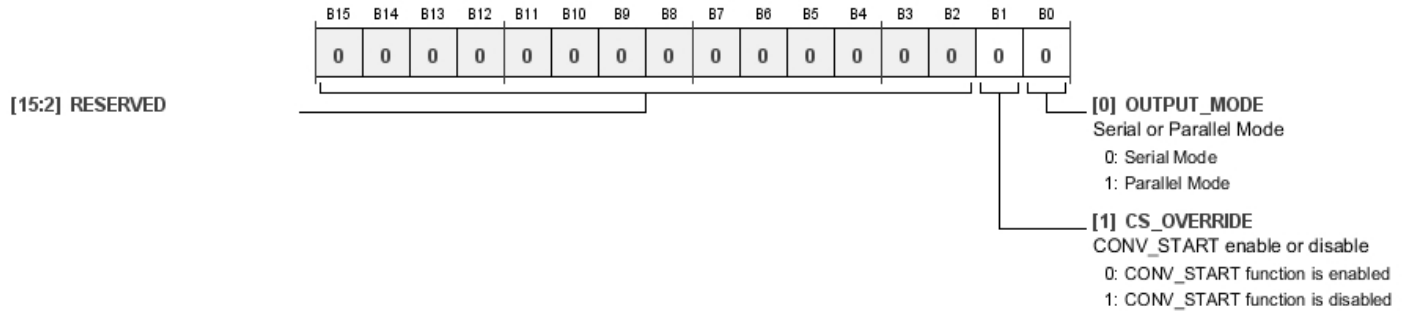

Table 51. Bit Descriptions for OUTPUT_MODE

Bits	Bit Name	Settings	Description	Reset	Access
1	CS_OVERRIDE	0 1	CONV_START Enable or Disable. CONV_START Function is Enabled CONV_START Function is Disabled	0x0	RW
0	OUTPUT_MODE	0 1	Serial or Parallel Mode. Serial Mode Parallel Mode	0x0	RW

AUXILIARY ADC READ VALUE REGISTERS

Address: 0x200, Reset: 0x0000, Name: ADC_READ0

This register contains the output data of the auxiliary ADC for the given channel. Each of the two channels are updated once per sample frame.

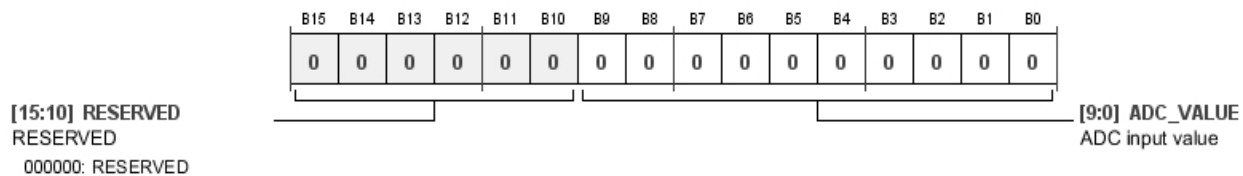

Table 52. Bit Descriptions for ADC_READ0

Bits	Bit Name	Settings	Description	Reset	Access
[9:0]	ADC_VALUE		ADC Input Value. Instantaneous value of the sampled data on the ADC input.	0x000	RW

Address: 0x201, Reset: 0x0000, Name: ADC_READ1

This register contains the output data of the auxiliary ADC for the given channel. Each of the two channels are updated once per sample frame.

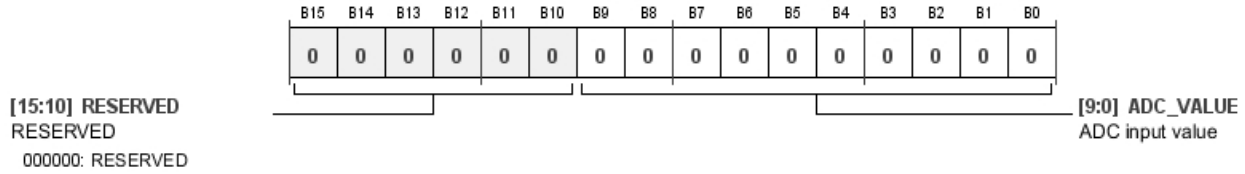

Table 53. Bit Descriptions for ADC_READ1

Bits	Bit Name	Settings	Description	Reset	Access
[9:0]	ADC_VALUE		ADC Input Value. Instantaneous value of the sampled data on the ADC input.	0x000	RW

AUXILIARY ADC SAMPLE RATE SELECTION REGISTER

Address: 0x210, Reset: 0x0000, Name: ADC_SPEED

This register sets the sample rate for the auxiliary ADCs.

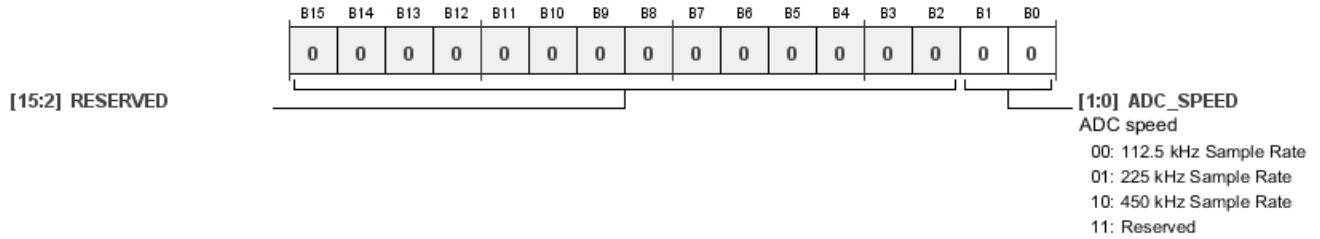

Table 54. Bit Descriptions for ADC_SPEED

Bits	Bit Name	Settings	Description	Reset	Access
[1:0]	ADC_SPEED		ADC Speed. Test register allowing the auxiliary ADCs to be sampled at double rate or half rate.	0x0	RW
		00	112.5 kHz Sample Rate.		
		01	225 kHz Sample Rate.		
		10	450 kHz Sample Rate.		
		11	Reserved.		

AUXILIARY ADC MODE REGISTER

Address: 0x211, Reset: 0x0000, Name: ADC_MODE

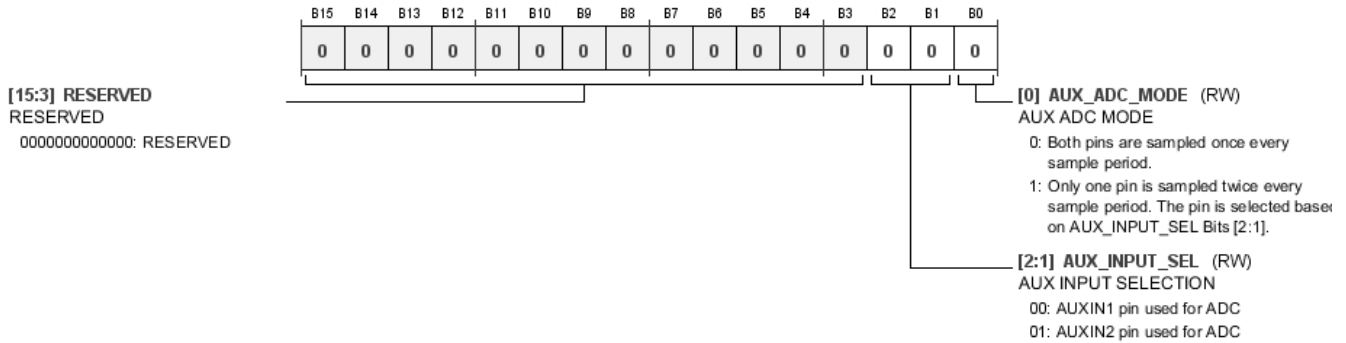

Table 55. Bit Descriptions for ADC_MODE

Bits	Bit Name	Settings	Description	Reset	Access
[2:1]	AUX_INPUT_SEL	00 01	AUX Input Selection. AUXIN1 pin used for ADC AUXIN2 pin used for ADC	0x0	RW
0	AUX_ADC_MODE	0 1	AUX ADC Mode. Both pins are sampled once every sample period. Only one pin is sampled twice every sample period. The pin is selected based on AUX_INPUT_SEL Bits[2:1].	0x0	RW

MPX PIN MODES REGISTERS

Address: 0x250, Reset: 0x0000, Name: MP0_MODE

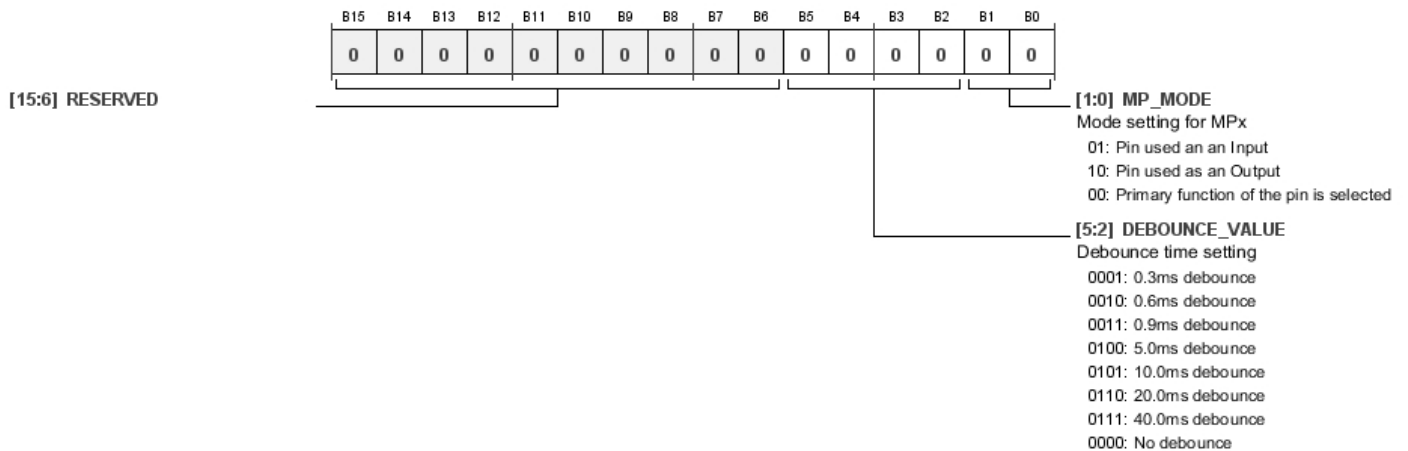

Table 56. Bit Descriptions for MP0_MODE

Bits	Bit Name	Settings	Description	Reset	Access
[5:2]	DEBOUNCE_VALUE	0001 0010 0011 0100 0101 0110	Debounce Time Setting. 0.3 ms Debounce. 0.6 ms Debounce. 0.9 ms Debounce. 5.0 ms Debounce. 10.0 ms Debounce. 20.0 ms Debounce.	0x0	RW

Bits	Bit Name	Settings	Description	Reset	Access
		0111 0000	40.0 ms Debounce. No Debounce.		
[1:0]	MP_MODE	01 10 00	Mode Setting for MP. Pin Used as an Input. Pin Used as an Output. Primary Function of the Pin is Selected.	0x0	RW

Address: 0x251, Reset: 0x0000, Name: MP1_MODE

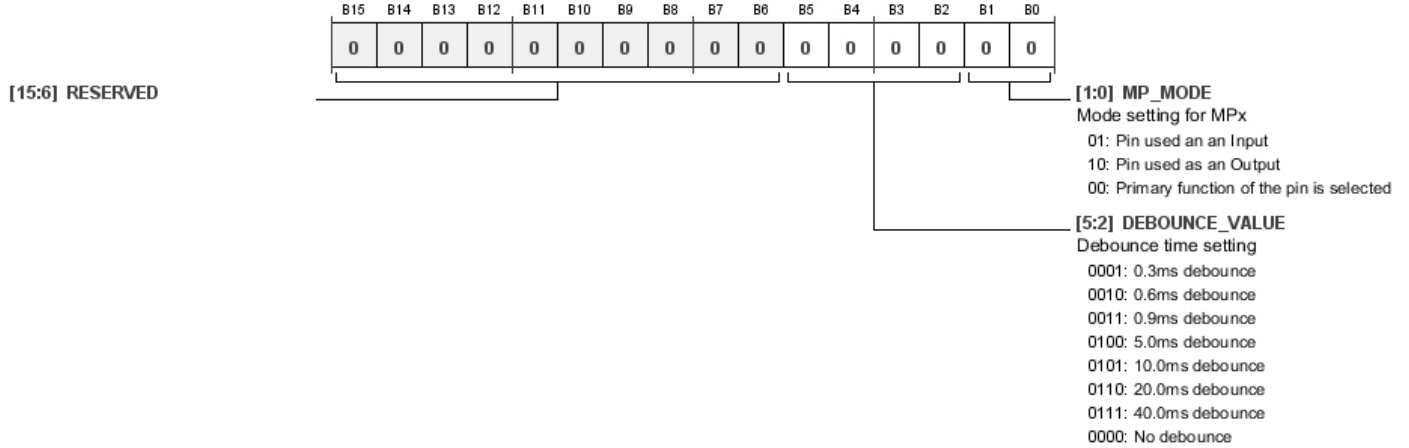

Table 57. Bit Descriptions for MP1_MODE

Bits	Bit Name	Settings	Description	Reset	Access
[5:2]	DEBOUNCE_VALUE	0001 0010 0011 0100 0101 0110 0111 0000	Debounce Time Setting. 0.3 ms Debounce. 0.6 ms Debounce. 0.9 ms Debounce. 5.0 ms Debounce. 10.0 ms Debounce. 20.0 ms Debounce. 40.0 ms Debounce. No Debounce.	0x0	RW
[1:0]	MP_MODE	01 10 00	Mode setting for MP. Pin Used as an Input. Pin Used as an Output. Primary Function of the Pin is Selected.	0x0	RW

MP WRITE VALUE REGISTERS

Address: 0x260, Reset: 0x0000, Name: MP0_WRITE

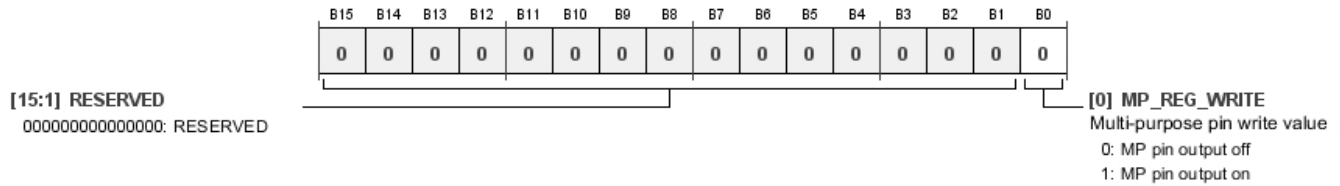

Table 58. Bit Descriptions for MP0_WRITE

Bits	Bit Name	Settings	Description	Reset	Access
0	MP_REG_WRITE	0 1	Multipurpose Pin Write Value. MP Pin Output Off. MP Pin Output On.	0x0	W

Address: 0x261, Reset: 0x0000, Name: MP1_WRITE

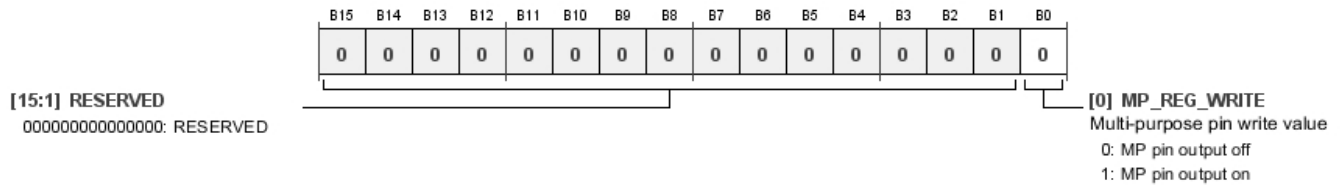

Table 59. Bit Descriptions for MP1_WRITE

Bits	Bit Name	Settings	Description	Reset	Access
0	MP_REG_WRITE	0 1	Multipurpose Pin Write Value. MP Pin Output Off. MP Pin Output On.	0x0	W

MP READ VALUE REGISTERS

Address: 0x270, Reset: 0x0000, Name: MP0_READ

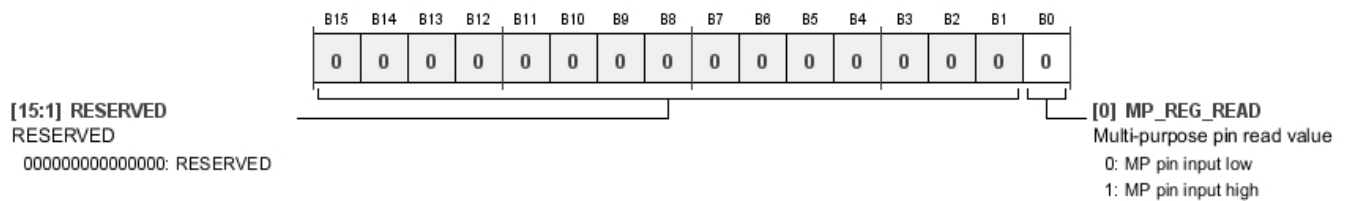

Table 60. Bit Descriptions for MP0_READ

Bits	Bit Name	Settings	Description	Reset	Access
0	MP_REG_READ	0 1	Multipurpose Pin Read Value. MP Pin Input Low. MP Pin Input High.	0x0	R

Address: 0x271, Reset: 0x0000, Name: MPI_READ

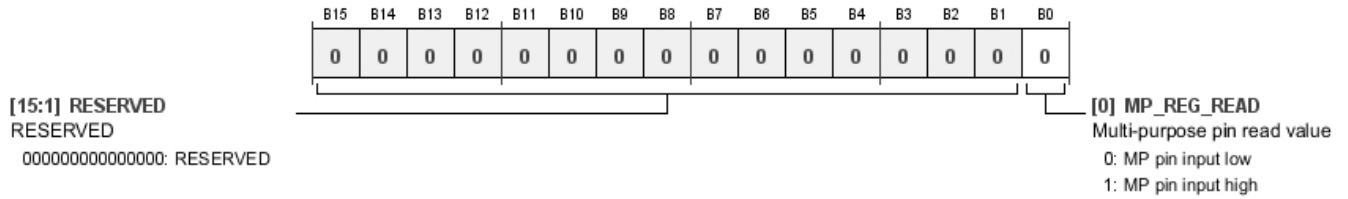

Table 61. Bit Descriptions for MPI_READ

Bits	Bit Name	Settings	Description	Reset	Access
0	MP_REG_READ	0 1	Multipurpose Pin Read Value. MP Pin Input Low. MP Pin Input High.	0x0	R

SPI_CLK PIN DRIVE STRENGTH AND SLEW RATE REGISTER

Address: 0x280, Reset: 0x0000, Name: SPI_CLK_PIN

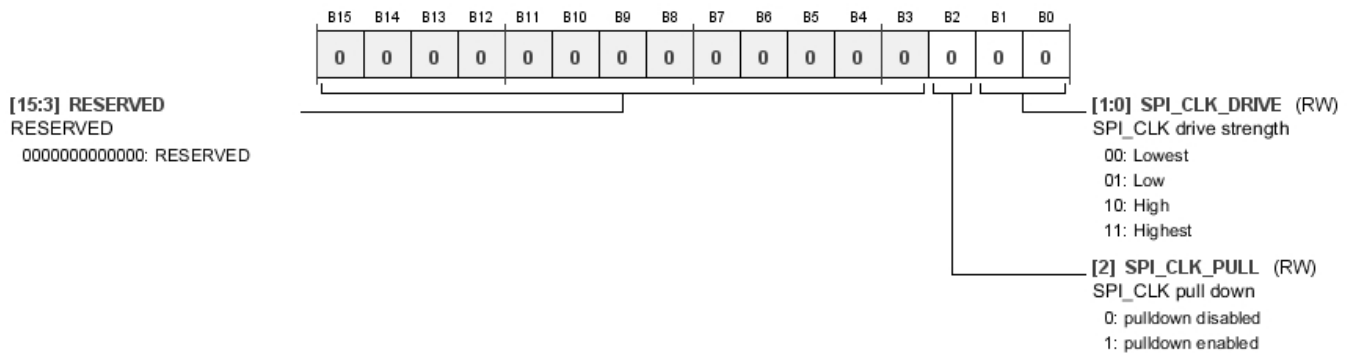

Table 62. Bit Descriptions for SPI_CLK_PIN

Bits	Bit Name	Settings	Description	Reset	Access
2	SPI_CLK_PULL	0 1	SPI_CLK Pull-Down. Pull-Down Disabled. Pull-Down Enabled.	0x0	RW
[1:0]	SPI_CLK_DRIVE	00 01 10 11	SPI_CLK Drive Strength. Lowest. Low. High. Highest.	0x0	RW

SPI_MISO PIN DRIVE STRENGTH AND SLEW RATE REGISTER

Address: 0x281, Reset: 0x0000, Name: MISO_PIN

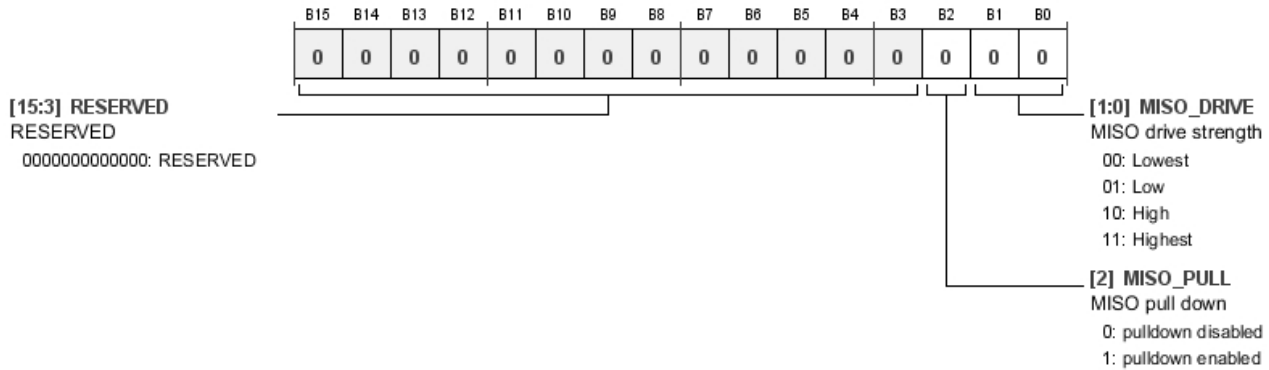

Table 63. Bit Descriptions for MISO_PIN

Bits	Bit Name	Settings	Description	Reset	Access
2	MISO_PULL	0 1	SPI_MISO Pull-Down. Pull-Down Disabled. Pull-Down Enabled.	0x0	RW
[1:0]	MISO_DRIVE	00 01 10 11	SPI_MISO Drive Strength. Lowest. Low. High. Highest.	0x0	RW

SPI_SS PIN DRIVE STRENGTH AND SLEW RATE REGISTER

Address: 0x282, Reset: 0x0004, Name: SS_PIN

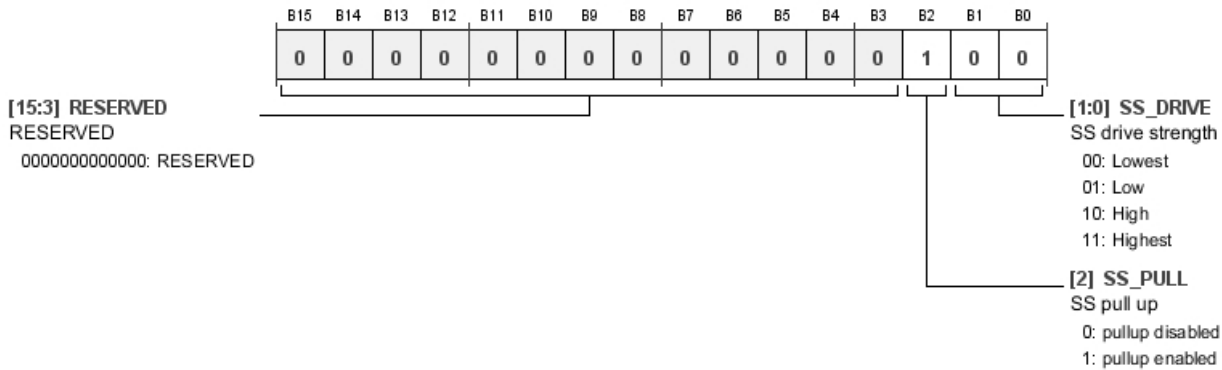

Table 64. Bit Descriptions for SS_PIN

Bits	Bit Name	Settings	Description	Reset	Access
2	SS_PULL	0 1	SPI_SS Pull-Up. Pull-Up Disabled. Pull-Up Enabled.	0x1	RW

Bits	Bit Name	Settings	Description	Reset	Access
[1:0]	SS_DRIVE	00 01 10 11	SPI_SS Drive Strength. Lowest. Low. High. Highest.	0x0	RW

SPI_MOSI PIN DRIVE STRENGTH AND SLEW RATE REGISTER

Address: 0x283, Reset: 0x0000, Name: MOSI_PIN

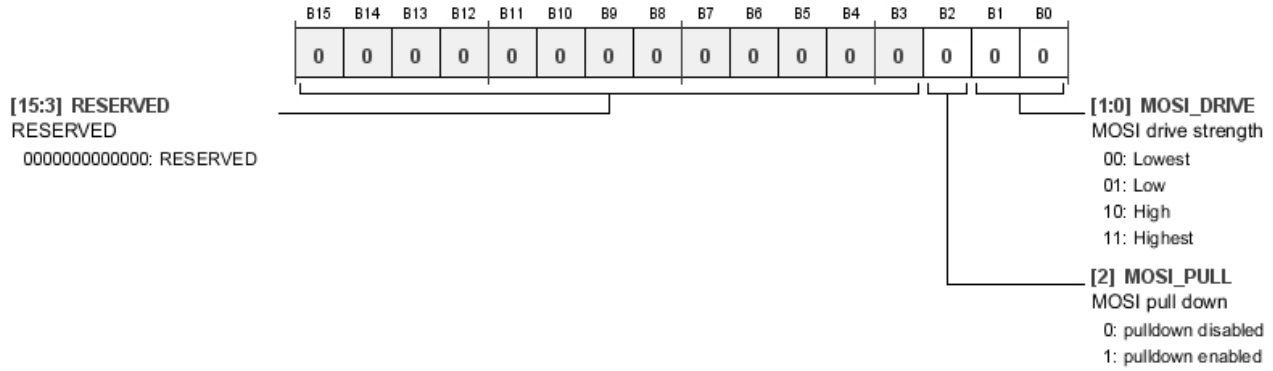

Table 65. Bit Descriptions for MOSI_PIN

Bits	Bit Name	Settings	Description	Reset	Access
2	MOSI_PULL	0 1	SPI_MOSI Pull-Down. Pull-Down Disabled. Pull-Down Enabled.	0x0	RW
[1:0]	MOSI_DRIVE	00 01 10 11	SPI_MOSI Drive Strength. Lowest. Low. High. Highest.	0x0	RW

ADDR15 PIN DRIVE STRENGTH AND SLEW RATE REGISTER

Address: 0x284, Reset: 0x0000, Name: ADDR15_PIN

This register also controls the drive strength setting for ADC_DOUT6 in PPI mode.

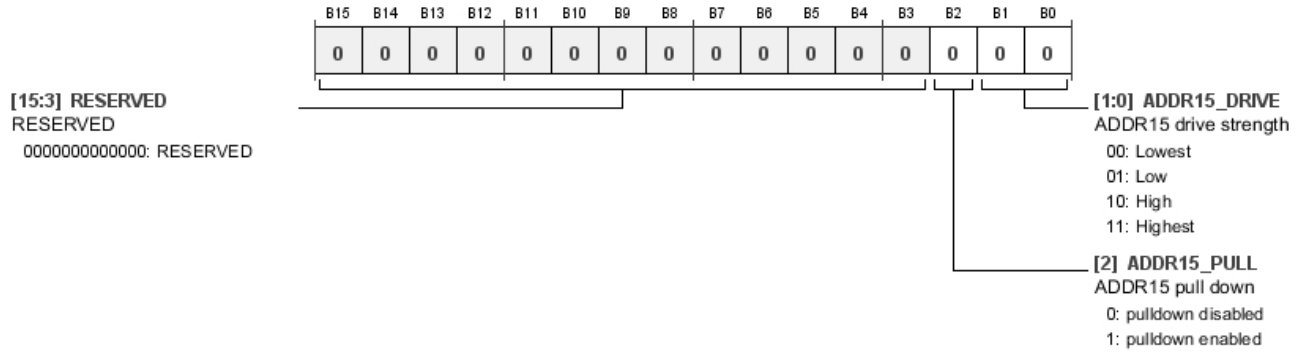

Table 66. Bit Descriptions for ADDR15_PIN

Bits	Bit Name	Settings	Description	Reset	Access
2	ADDR15_PULL	0 1	ADDR15 Pull-Down. Pull-Down Disabled. Pull-Down Enabled.	0x0	RW
[1:0]	ADDR15_DRIVE	00 01 10 11	ADDR15 Drive Strength. Lowest. Low. High. Highest.	0x0	RW

FAULT PIN DRIVE STRENGTH AND SLEW RATE REGISTER

Address: 0x285, Reset: 0x0004, Name: FAULT_PIN

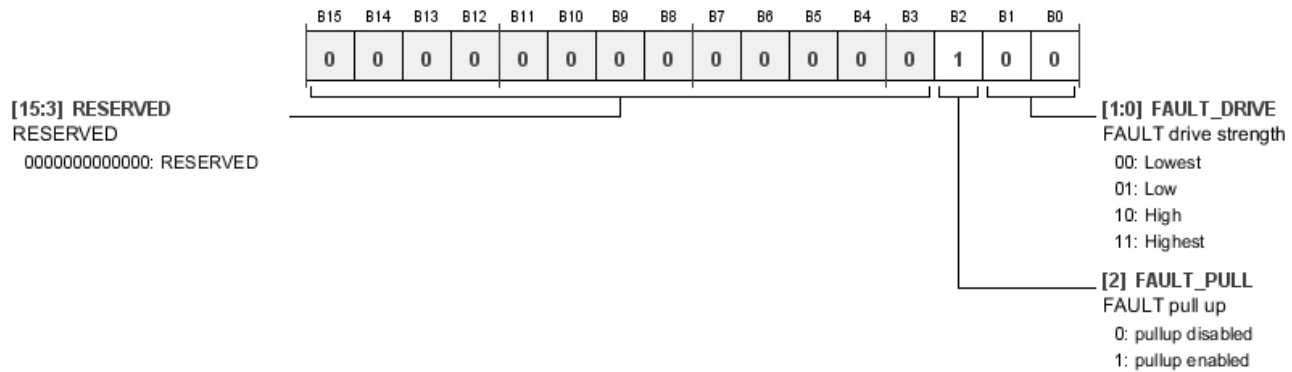

Table 67. Bit Descriptions for FAULT_PIN

Bits	Bit Name	Settings	Description	Reset	Access
2	FAULT_PULL	0 1	FAULT Pull-Up. Pull-Up Disabled. Pull-Up Enabled.	0x1	RW

Bits	Bit Name	Settings	Description	Reset	Access
[1:0]	FAULT_DRIVE	00 01 10 11	FAULT Drive Strength. Lowest. Low. High. Highest.	0x0	RW

FS_ADC PIN DRIVE STRENGTH AND SLEW RATE REGISTER

Address: 0x286, Reset: 0x0000, Name: FS_ADC_PIN

This register also controls the drive strength setting for ADC_DOUT7 in PPI mode.

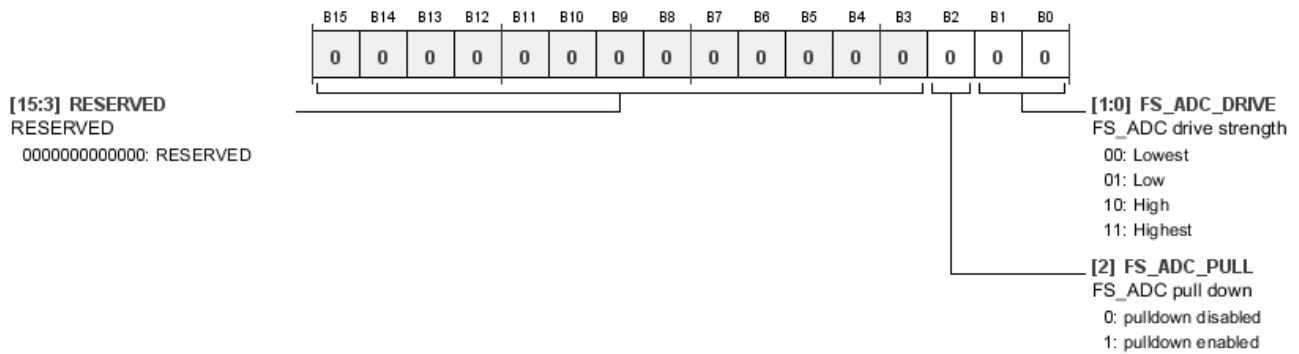

Table 68. Bit Descriptions for FS_ADC_PIN

Bits	Bit Name	Settings	Description	Reset	Access
2	FS_ADC_PULL	0 1	FS_ADC Pull-Down. Pull-Down Disabled. Pull-Down Enabled.	0x0	RW
[1:0]	FS_ADC_DRIVE	00 01 10 11	FS_ADC Drive Strength. Lowest. Low. High. Highest.	0x0	RW

CONV_START PIN DRIVE STRENGTH AND SLEW RATE REGISTER

Address: 0x287, Reset: 0x0004, Name: CS_PIN

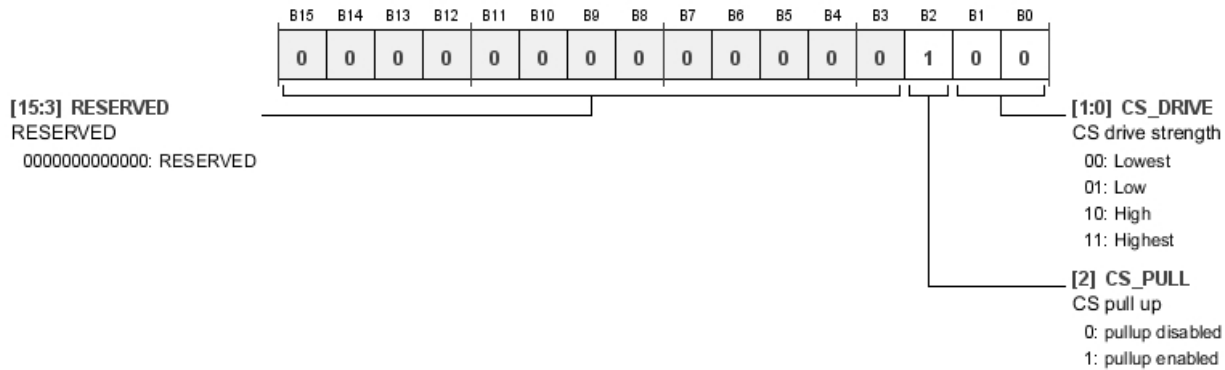

Table 69. Bit Descriptions for CS_PIN

Bits	Bit Name	Settings	Description	Reset	Access
2	CS_PULL	0 1	CONV_START Pull-Up. Pull-Up Disabled. Pull-Up Enabled.	0x1	RW
[1:0]	CS_DRIVE	00 01 10 11	CONV_START Drive Strength. Lowest. Low. High. Highest.	0x0	RW

SCLK_ADC PIN DRIVE STRENGTH AND SLEW RATE REGISTER

Address: 0x288, Reset: 0x0000, Name: SCLK_ADC_PIN

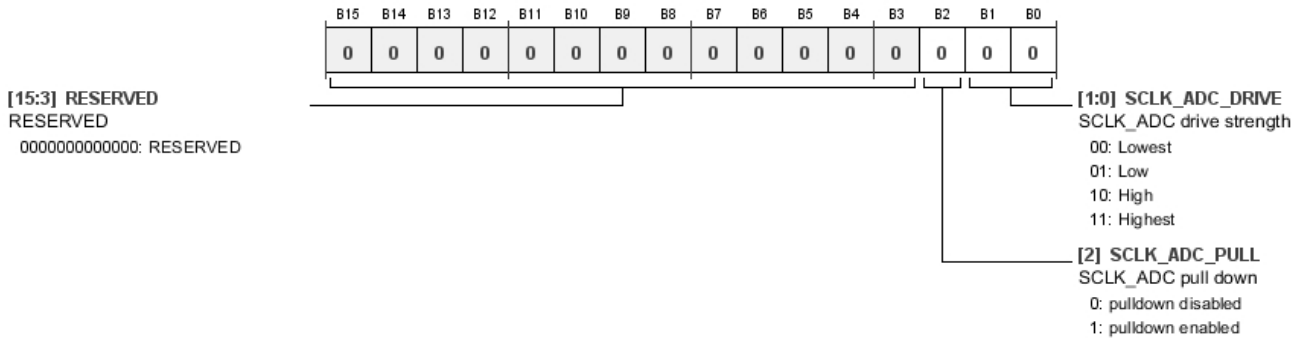

Table 70. Bit Descriptions for SCLK_ADC_PIN

Bits	Bit Name	Settings	Description	Reset	Access
2	SCLK_ADC_PULL	0 1	SCLK_ADC Pull-Down. Pull-Down Disabled. Pull-Down Enabled.	0x0	RW
[1:0]	SCLK_ADC_DRIVE	00 01 10 11	SCLK_ADC Drive Strength. Lowest. Low. High. Highest.	0x0	RW

ADC_DOUTX PINS DRIVE STRENGTH AND SLEW RATE REGISTERS

The following registers refer to the ADC_DOUTx pins. This range includes ADC_DOUT0 through ADC_DOUT5. For Bits[1:0] and Bit 2 in Table 71 through Table 76, ADC_DOUT refers to the ADC_DOUTx pin defined by the register name.

Address: 0x289, Reset: 0x0000, Name: ADC_DOUT0_PIN

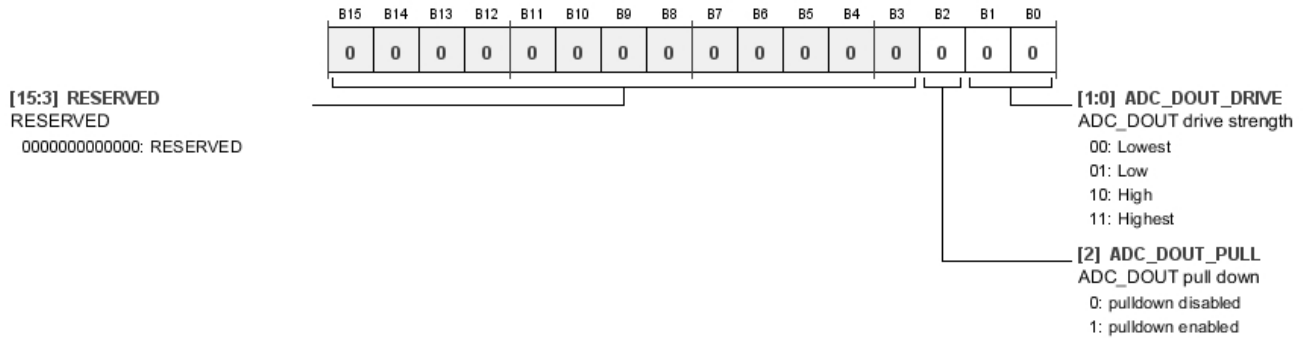

Table 71. Bit Descriptions for ADC_DOUT0_PIN

Bits	Bit Name	Settings	Description	Reset	Access
2	ADC_DOUT_PULL	0 1	ADC_DOUT Pull-Down. Pull-Down Disabled. Pull-Down Enabled.	0x0	RW
[1:0]	ADC_DOUT_DRIVE	00 01 10 11	ADC_DOUT Drive Strength. Lowest. Low. High. Highest.	0x0	RW

Address: 0x28A, Reset: 0x0000, Name: ADC_DOUT1_PIN

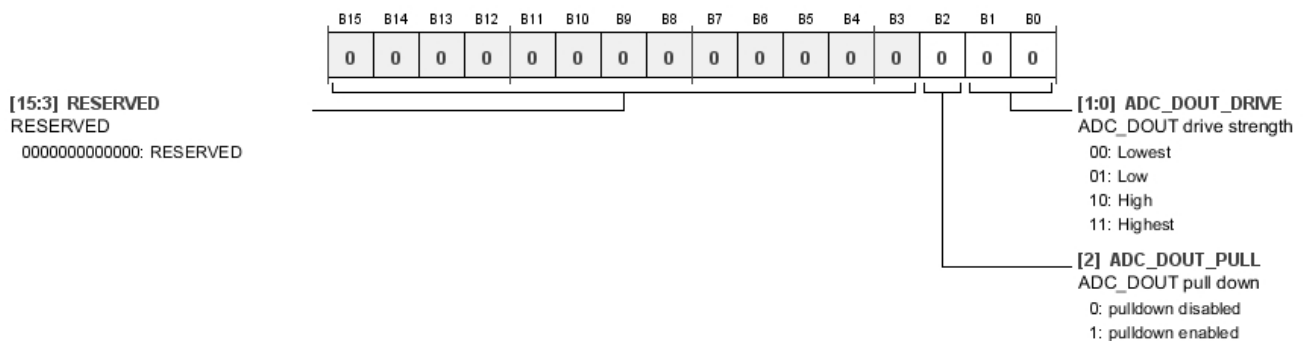

Table 72. Bit Descriptions for ADC_DOUT1_PIN

Bits	Bit Name	Settings	Description	Reset	Access
2	ADC_DOUT_PULL	0 1	ADC_DOUT Pull-Down. Pull-Down Disabled. Pull-Down Enabled.	0x0	RW
[1:0]	ADC_DOUT_DRIVE	00 01 10 11	ADC_DOUT Drive Strength. Lowest. Low. High. Highest.	0x0	RW

Address: 0x28B, Reset: 0x0000, Name: ADC_DOUT2_PIN

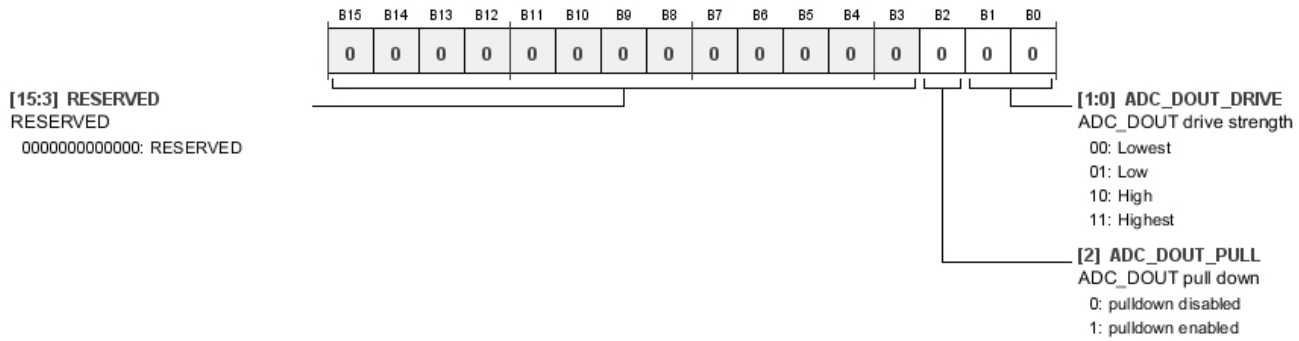

Table 73. Bit Descriptions for ADC_DOUT2_PIN

Bits	Bit Name	Settings	Description	Reset	Access
2	ADC_DOUT_PULL	0 1	ADC_DOUT Pull-Down. Pull-Down Disabled. Pull-Down Enabled.	0x0	RW
[1:0]	ADC_DOUT_DRIVE	00 01 10 11	ADC_DOUT Drive Strength. Lowest. Low. High. Highest.	0x0	RW

Address: 0x28C, Reset: 0x0000, Name: ADC_DOUT3_PIN

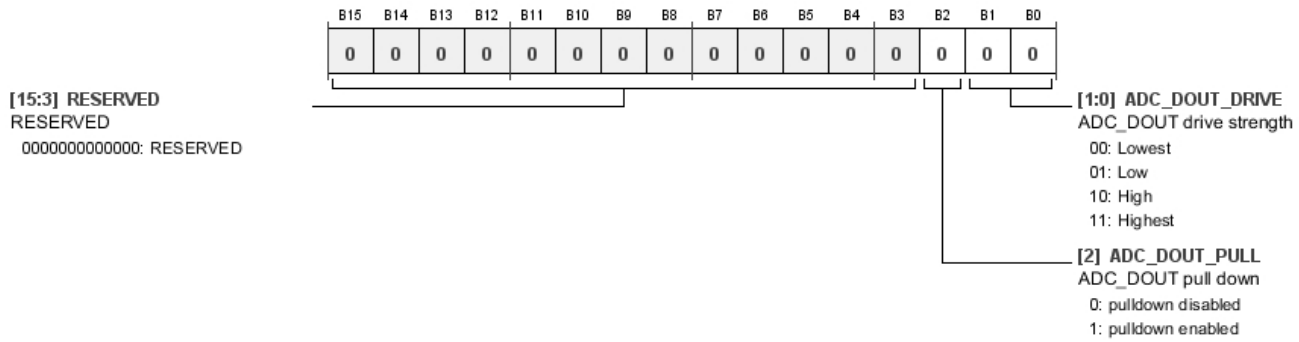

Table 74. Bit Descriptions for ADC_DOUT3_PIN

Bits	Bit Name	Settings	Description	Reset	Access
2	ADC_DOUT_PULL	0 1	ADC_DOUT Pull-Down. Pull-Down Disabled. Pull-Down Enabled.	0x0	RW
[1:0]	ADC_DOUT_DRIVE	00 01 10 11	ADC_DOUT Drive Strength. Lowest. Low. High. Highest.	0x0	RW

Address: 0x28D, Reset: 0x0000, Name: ADC_DOUT4_PIN

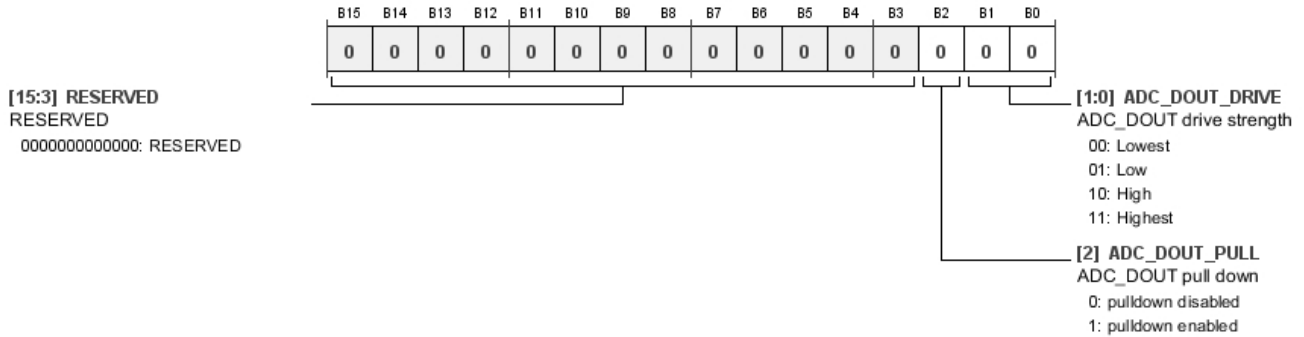

Table 75. Bit Descriptions for ADC_DOUT4_PIN

Bits	Bit Name	Settings	Description	Reset	Access
2	ADC_DOUT_PULL	0 1	ADC_DOUT Pull-Down. Pull-Down Disabled. Pull-Down Enabled.	0x0	RW
[1:0]	ADC_DOUT_DRIVE	00 01 10 11	ADC_DOUT Drive Strength. Lowest. Low. High. Highest.	0x0	RW

Address: 0x28E, Reset: 0x0000, Name: ADC_DOUT5_PIN

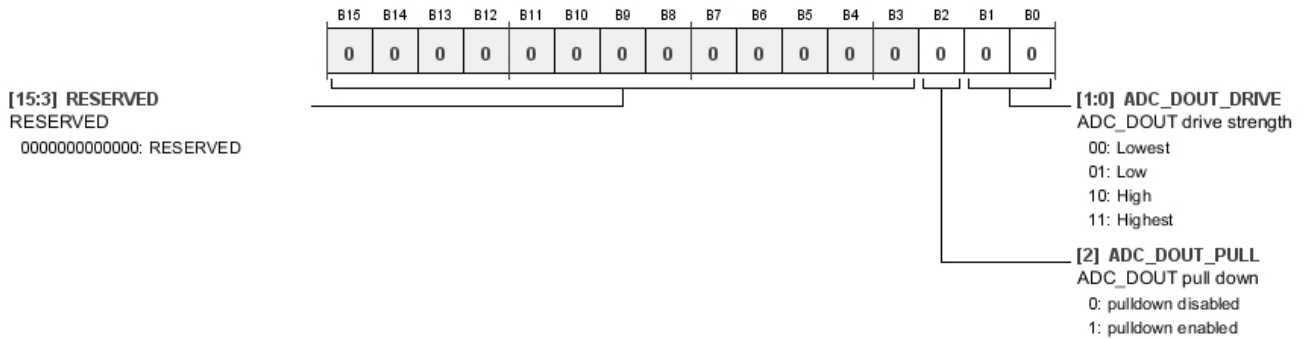

Table 76. Bit Descriptions for ADC_DOUT5_PIN

Bits	Bit Name	Settings	Description	Reset	Access
2	ADC_DOUT_PULL	0 1	ADC_DOUT Pull-Down. Pull-Down Disabled. Pull-Down Enabled.	0x0	RW
[1:0]	ADC_DOUT_DRIVE	00 01 10 11	ADC_DOUT Drive Strength. Lowest. Low. High. Highest.	0x0	RW

DATA_READY PIN DRIVE STRENGTH AND SLEW RATE REGISTER

Address: 0x291, Reset: 0x0000, Name: DATA_READY_PIN

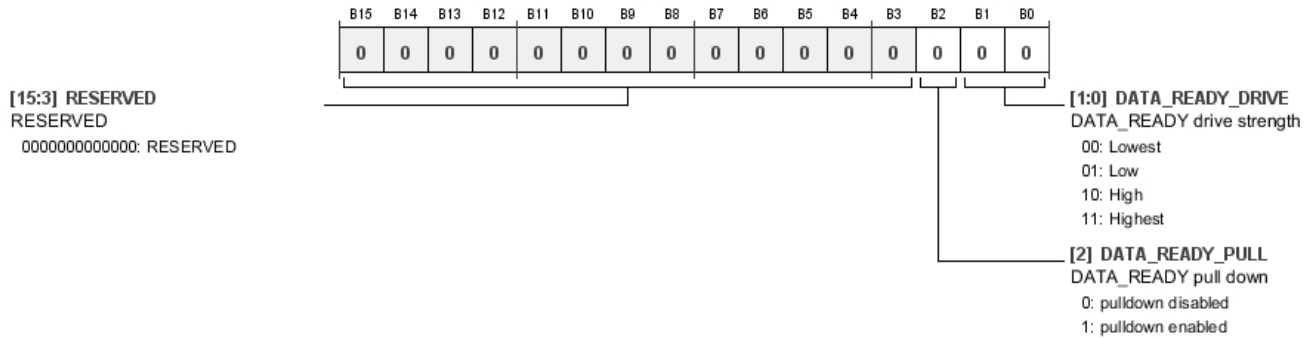

Table 77. Bit Descriptions for DATA_READY_PIN

Bits	Bit Name	Settings	Description	Reset	Access
2	DATA_READY_PULL	0 1	DATA_READY Pull-Down. Pull-Down Disabled. Pull-Down Enabled.	0x0	RW
[1:0]	DATA_READY_DRIVE	00 01 10 11	DATA_READY Drive Strength. Lowest. Low. High. Highest.	0x0	RW

XTAL ENABLE AND DRIVE REGISTER

Address: 0x292, Reset: 0x0000, Name: XTAL_CTRL

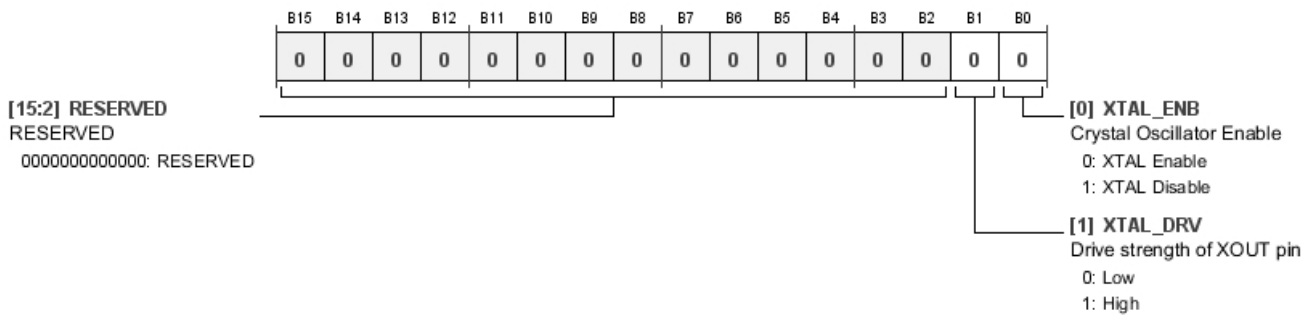

Table 78. Bit Descriptions for XTAL_CTRL

Bits	Bit Name	Settings	Description	Reset	Access
1	XTAL_DRV	0 1	Drive Strength of XOUT Pin. Low. High.	0x0	RW
0	XTAL_ENB	0 1	Crystal Oscillator Enable. XTAL Enable. XTAL Disable.	0x0	RW

ADC TEST REGISTER

Address: 0x301, Reset: 0x0304, Name: ADC_SETTING1

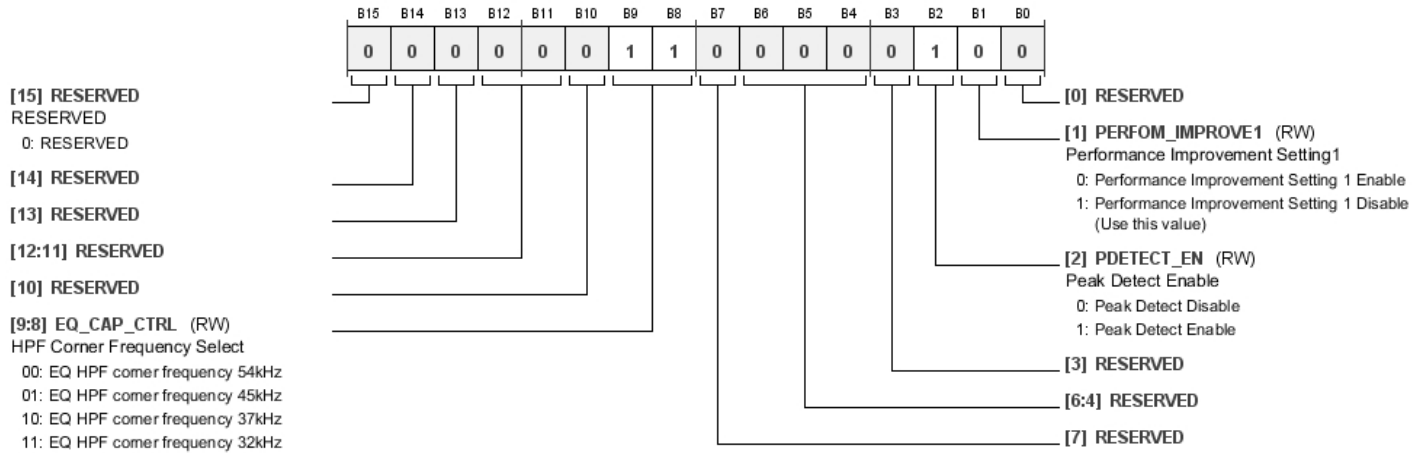

Table 79. Bit Descriptions for ADC_SETTING1

Bits	Bit Name	Settings	Description	Reset	Access
[9:8]	EQ_CAP_CTRL	00 01 10 11	HPF Corner Frequency Select. EQ HPF corner frequency 54 kHz EQ HPF corner frequency 45 kHz EQ HPF corner frequency 37 kHz EQ HPF corner frequency 32 kHz	0x3	RW
2	PDETECT_EN	0 1	Peak Detect Enable. Peak Detect Disable Peak Detect Enable	0x1	RW
1	PERFOM_IMPROVE1	0 1	Performance Improvement Setting 1. Performance Improvement Setting 1 Enable Performance Improvement Setting 1 Disable (Use this value)	0x0	RW

Address: 0x308, Reset: 0x0000, Name: ADC_SETTING2

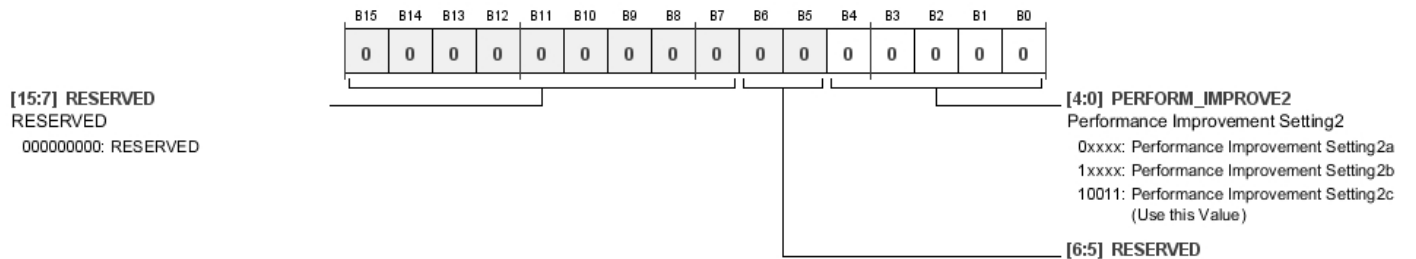

Table 80. Bit Descriptions for ADC_SETTING2

Bits	Bit Name	Settings	Description	Reset	Access
[4:0]	PERFORM_IMPROVE2	0xxxx 1xxxx 10011	Performance Improvement Setting 2. Performance Improvement Setting 2a. Performance Improvement Setting 2b. Performance Improvement Setting 2c (Use This Value)	0x00	RW

Address: 0x30A, Reset: 0x0009, Name: ADC_SETTING3

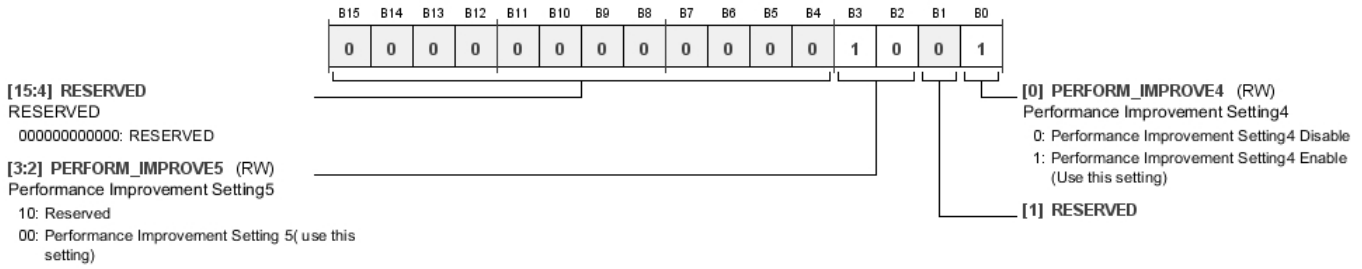

Table 81. Bit Descriptions for ADC_SETTING3

Bits	Bit Name	Settings	Description	Reset	Access
[3:2]	PERFORM_IMPROVE5	10 00	Performance Improvement Setting 5. Reserved. Performance Improvement Setting 5 (Use This Setting).	0x2	RW
0	PERFORM_IMPROVE4	0 1	Performance Improvement Setting 4. Performance Improvement Setting 4 Disable. Performance Improvement Setting 4 Enable (Use This Setting).	0x1	RW

DIGITAL FILTER SYNC ENABLE REGISTER

Address: 0x30E, Reset: 0x0003, Name: DEJITTER_WINDOW

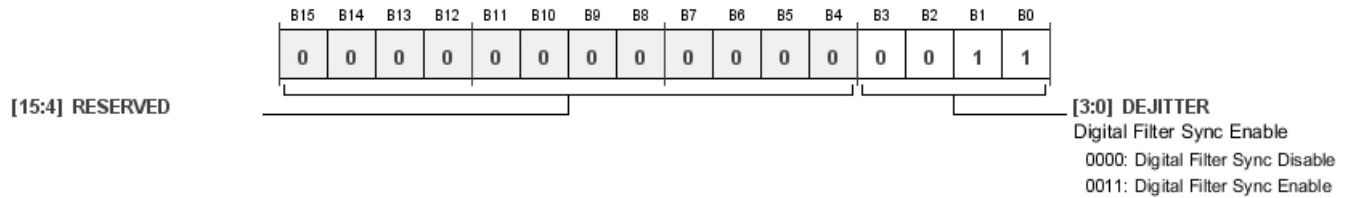

Table 82. Bit Descriptions for DEJITTER_WINDOW

Bits	Bit Name	Settings	Description	Reset	Access
[3:0]	DEJITTER	0000 0011	Digital Filter Sync Enable. Digital Filter Sync Disable. Digital Filter Sync Enable.	0x3	RW

CRC ENABLE/DISABLE REGISTER

Address: 0xFD00, Reset: 0x0000, Name: CRC_EN

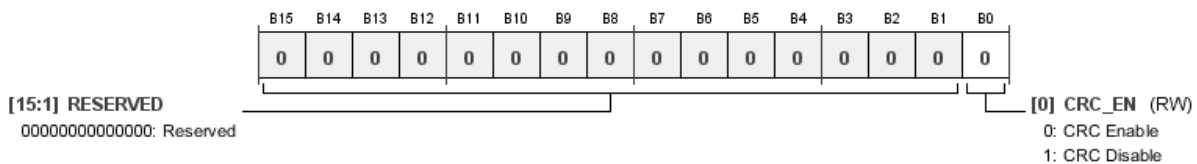
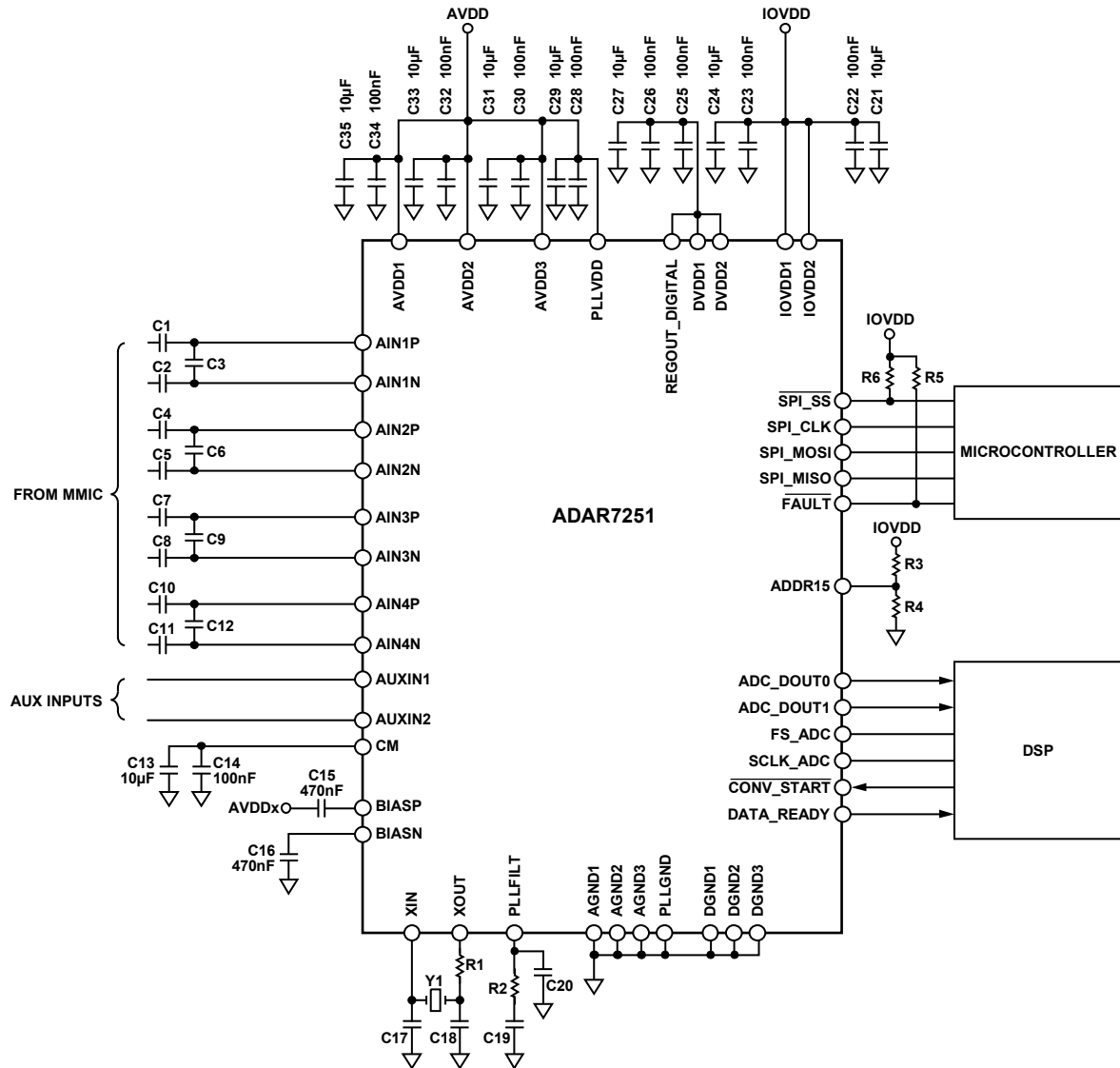

Table 83. Bit Descriptions for CRC_EN

Bits	Bit Name	Settings	Description	Reset	Access
0	CRC_EN	0 1	CRC Enable CRC Disable	0x0	RW

TYPICAL APPLICATION CIRCUIT



C1, C2, C4, C5, C7, C8, C10, C11: SEE HIGH-PASS FILTER (HPF) SECTION
 C3, C6, C9, C12: SEE LOW-PASS FILTER (LPF) SECTION
 C17, C18: 12pF TO 18pF, SELECT BASED ON CRYSTAL
 R1: 100Ω TYPICAL. SELECT BASED ON CRYSTAL
 C19: 5.6nF
 C20: 390pF
 R2: 1kΩ
 R3, R4: 10kΩ; USE EITHER PULL-UP OR PULL-DOWN BASED ON DEVICE ADDRESS
 R5, R6: 10kΩ TYPICAL
 CONV_START AND DATA_READY SIGNALS MAY NOT BE NECESSARY, SEE ADC SERIAL MODE SECTION
 FS_ADC AND SCLK_ADC DIRECTION DEPENDS ON THE MASTER OR SLAVE MODE
 Y1: 19.2MHz TYPICAL. ACCEPTABLE RANGE IS 16MHz TO 54MHz. ALTERNATELY CLOCK AVAILABLE IN THE SYSTEM CAN BE CONNECTED TO XIN.

Figure 60. Typical Application Circuit, 4-Channel, Serial Mode

112357-045

OUTLINE DIMENSIONS

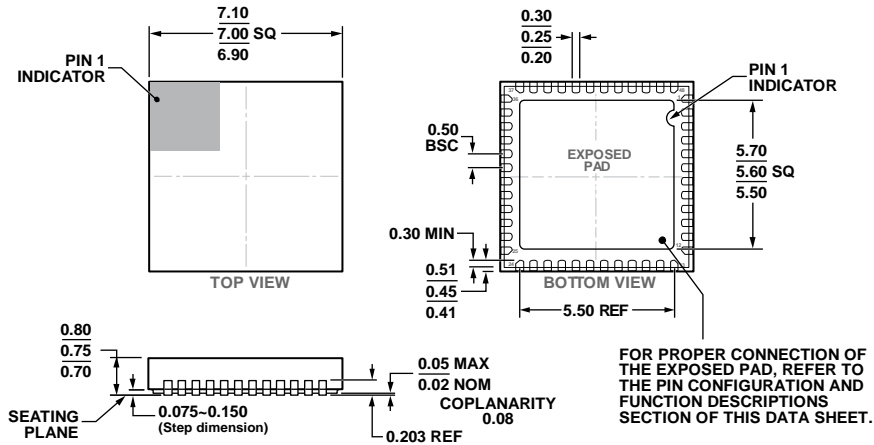

Figure 61. 48-Lead Lead Frame Chip Scale Package [LFCSP_SS]
 7 mm × 7 mm Body, With Side Solderable Leads
 (CS-48-1)
 Dimensions shown in millimeters

ORDERING GUIDE

Model ^{1,2}	Temperature Range	Package Description	Package Option
ADAR7251WBCSZ	-40°C to +125°C	48-Lead LFCSP_SS	CS-48-1
ADAR7251WBCSZ-RL	-40°C to +125°C	48-Lead LFCSP_SS, 13" Tape and Reel	CS-48-1
EVAL-ADAR7251Z		Evaluation Board	

¹ Z = RoHS Compliant Part.
² W = Qualified for Automotive Applications.

AUTOMOTIVE PRODUCTS

The ADAR7251W models are available with controlled manufacturing to support the quality and reliability requirements of automotive applications. Note that these automotive models may have specifications that differ from the commercial models; therefore, designers should review the Specifications section of this data sheet carefully. Only the automotive grade products shown are available for use in automotive applications. Contact your local Analog Devices account representative for specific product ordering information and to obtain the specific Automotive Reliability reports for these models.

Mouser Electronics

Authorized Distributor

Click to View Pricing, Inventory, Delivery & Lifecycle Information:

[Analog Devices Inc.:](#)

[ADAR7251WBCSZ-RL](#) [ADAR7251WBCSZ](#) [EVAL-ADAR7251Z](#)