

TABLE OF CONTENTS

| | | | |
|--|----|---------------------------------------|----|
| Features | 1 | Serial Interface | 18 |
| Applications..... | 1 | Powering Up the AD9834 | 18 |
| General Description | 1 | Latency..... | 18 |
| Functional Block Diagram | 1 | Control Register | 18 |
| Revision History | 3 | Frequency and Phase Registers | 20 |
| Specifications..... | 4 | Writing to a Frequency Register..... | 21 |
| Timing Characteristics | 6 | Writing to a Phase Register..... | 21 |
| Absolute Maximum Ratings..... | 7 | RESET Function | 21 |
| ESD Caution..... | 7 | SLEEP Function..... | 21 |
| Pin Configuration and Function Descriptions..... | 8 | SIGN BIT OUT Pin..... | 22 |
| Typical Performance Characteristics | 10 | The IOUT and IOUTB Pins..... | 22 |
| Terminology | 14 | Applications Information | 23 |
| Theory of Operation | 15 | Grounding and Layout | 26 |
| Circuit Description..... | 16 | Interfacing to Microprocessors..... | 27 |
| Numerically Controlled Oscillator Plus Phase Modulator ... | 16 | AD9834 to ADSP-21xx Interface | 27 |
| SIN ROM..... | 16 | AD9834 to 68HC11/68L11 Interface..... | 27 |
| Digital-to-Analog Converter (DAC) | 16 | AD9834 to 80C51/80L51 Interface | 28 |
| Comparator | 16 | AD9834 to DSP56002 Interface | 28 |
| Regulator..... | 17 | Outline Dimensions | 29 |
| Output Voltage Compliance..... | 17 | Ordering Guide | 29 |
| Functional Description | 18 | | |

REVISION HISTORY**3/14—Rev. C to Rev. D**

| | |
|--|----|
| Changes to Table 3 | 7 |
| Deleted Evaluation Board Section | 29 |
| Changes to Ordering Guide..... | 35 |

2/11—Rev. B to Rev. C

| | |
|---|----|
| Changes to I_{DD} Parameter, Table 1 | 5 |
| Changes to FS ADJUST Description, Table 4..... | 8 |
| Added Output Voltage Compliance Section..... | 17 |
| Changes to Figure 31 | 23 |
| Changes to Figure 32 | 24 |
| Deleted Using the AD9834 Evaluation Board Section and the Prototyping Area Section | 28 |
| Added System Development Platform Section, AD9834 to SPORT Interface Section, Figure 39, and Figure 40; Renumbered Sequentially | 29 |
| Changes to XO vs. External Clock Section and Power Supply Section | 29 |
| Deleted Bill of Materials, Table 19; Renumbered Sequentially | 30 |
| Added Evaluation Board Schematics Section and Figure 41 | 30 |
| Added Figure 42 | 31 |
| Added Evaluation Board Layout Section and Figure 43 | 32 |
| Added Figure 44 | 33 |
| Added Figure 45 | 34 |
| Changes to Ordering Guide..... | 35 |

4/10—Rev. A to Rev. B

| | |
|---|----|
| Changes to Comparator Section | 15 |
| Added Figure 28 | 16 |
| Changes to Serial Interface Section | 17 |

8/06—Rev. 0 to Rev. A

| | |
|--|-----------|
| Updated Format | Universal |
| Changed to 75 MHz Complete DDS | Universal |
| Changes to Features Section | 1 |
| Changes to Table 1 | 4 |
| Changes to Table 2 | 6 |
| Changes to Table 3 | 8 |
| Added Figure 10, Figures Renumbered Sequentially | 9 |
| Added Figure 16 and Figure 17, Figures Renumbered Sequentially | 10 |
| Changes to Table 6 | 19 |
| Changes to Writing a Frequency Register Section | 20 |
| Changes to Figure 29 | 21 |
| Changes to Table 19 | 30 |
| Changes to Figure 38 | 28 |

2/03—Revision 0: Initial Version

SPECIFICATIONS

VDD = 2.3 V to 5.5 V, AGND = DGND = 0 V, T_A = T_{MIN} to T_{MAX}, R_{SET} = 6.8 kΩ, R_{LOAD} = 200 Ω for IOUT and IOUTB, unless otherwise noted.

Table 1.

| Parameter ² | Grade B, Grade C ¹ | | | Unit | Test Conditions/Comments |
|---|-------------------------------|------|------|--------|--|
| | Min | Typ | Max | | |
| SIGNAL DAC SPECIFICATIONS | | | | | |
| Resolution | | 10 | | Bits | |
| Update Rate | | | 75 | MSPS | |
| I _{OUT} Full Scale ³ | | 3.0 | | mA | |
| V _{OUT} Max | | 0.6 | | V | |
| V _{OUT} Min | | 30 | | mV | |
| Output Compliance ⁴ | | | 0.8 | V | |
| DC Accuracy | | | | | |
| Integral Nonlinearity | | ±1 | | LSB | |
| Differential Nonlinearity | | ±0.5 | | LSB | |
| DDS SPECIFICATIONS | | | | | |
| Dynamic Specifications | | | | | |
| Signal-to-Noise Ratio | 55 | 60 | | dB | f _{MCLK} = 75 MHz, f _{OUT} = f _{MCLK} /4096 |
| Total Harmonic Distortion | | -66 | -56 | dBc | f _{MCLK} = 75 MHz, f _{OUT} = f _{MCLK} /4096 |
| Spurious-Free Dynamic Range (SFDR) | | | | | |
| Wideband (0 to Nyquist) | | -60 | -56 | dBc | f _{MCLK} = 75 MHz, f _{OUT} = f _{MCLK} /75 |
| Narrow Band (±200 kHz) | | | | | |
| B Grade | | -78 | -67 | dBc | f _{MCLK} = 50 MHz, f _{OUT} = f _{MCLK} /50 |
| C Grade | | -74 | -65 | dBc | f _{MCLK} = 75 MHz, f _{OUT} = f _{MCLK} /75 |
| Clock Feedthrough | | -50 | | dBc | |
| Wake-Up Time | | 1 | | ms | |
| COMPARATOR | | | | | |
| Input Voltage Range | | | 1 | V p-p | AC-coupled internally |
| Input Capacitance | | 10 | | pF | |
| Input High-Pass Cutoff Frequency | | 4 | | MHz | |
| Input DC Resistance | | 5 | | MΩ | |
| Input Leakage Current | | | 10 | μA | |
| OUTPUT BUFFER | | | | | |
| Output Rise/Fall Time | | 12 | | ns | Using a 15 pF load |
| Output Jitter | | 120 | | ps rms | 3 MHz sine wave, 0.6 V p-p |
| VOLTAGE REFERENCE | | | | | |
| Internal Reference | 1.12 | 1.18 | 1.24 | V | |
| REFOUT Output Impedance ⁵ | | 1 | | kΩ | |
| Reference Temperature Coefficient | | 100 | | ppm/°C | |
| LOGIC INPUTS | | | | | |
| Input High Voltage, V _{INH} | 1.7 | | | V | 2.3 V to 2.7 V power supply |
| | 2.0 | | | V | 2.7 V to 3.6 V power supply |
| | 2.8 | | | V | 4.5 V to 5.5 V power supply |
| Input Low Voltage, V _{INL} | | | 0.6 | V | 2.3 V to 2.7 V power supply |
| | | | 0.7 | V | 2.7 V to 3.6 V power supply |
| | | | 0.8 | V | 4.5 V to 5.5 V power supply |
| Input Current, I _{INH} /I _{INL} | | | 10 | μA | |
| Input Capacitance, C _{IN} | | 3 | | pF | |

| Parameter ² | Grade B, Grade C ¹ | | | Unit | Test Conditions/Comments |
|--------------------------------|-------------------------------|-----|-----|------|--|
| | Min | Typ | Max | | |
| POWER SUPPLIES | | | | | |
| AVDD | 2.3 | | 5.5 | V | $f_{MCLK} = 75 \text{ MHz}, f_{OUT} = f_{MCLK}/4096$ |
| DVDD | 2.3 | | 5.5 | V | |
| I_{AA} ⁶ | | 3.8 | 5 | mA | |
| I_{DD} ⁶ | | | | | |
| B Grade | | 2.0 | 3 | mA | I_{DD} code dependent (see Figure 8) |
| C Grade | | 2.7 | 3.7 | mA | I_{DD} code dependent (see Figure 8) |
| $I_{AA} + I_{DD}$ ⁶ | | | | | |
| B Grade | | 5.8 | 8 | mA | |
| C Grade | | 6.5 | 8.7 | mA | |
| Low Power Sleep Mode | | | | | |
| B Grade | | 0.5 | | mA | DAC powered down, MCLK running |
| C Grade | | 0.6 | | mA | DAC powered down, MCLK running |

¹ B grade: MCLK = 50 MHz; C grade: MCLK = 75 MHz. For specifications that do not specify a grade, the value applies to both grades.

² Operating temperature range is as follows: B, C versions: -40°C to +105°C, typical specifications are at 25°C.

³ For compliance, with specified load of 200 Ω, I_{OUT} full scale should not exceed 4 mA.

⁴ Guaranteed by design.

⁵ Applies when REFOUT is sourcing current. The impedance is higher when REFOUT is sinking current.

⁶ Measured with the digital inputs static and equal to 0 V or DVDD.

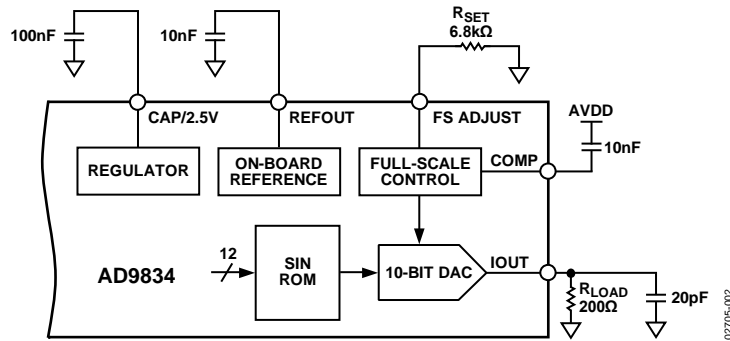

Figure 2. Test Circuit Used to Test the Specifications

TIMING CHARACTERISTICS

DVDD = 2.3 V to 5.5 V, AGND = DGND = 0 V, unless otherwise noted.

Table 2.

| Parameter ¹ | Limit at T _{MIN} to T _{MAX} | Unit | Test Conditions/Comments |
|------------------------|---|--------|---|
| t ₁ | 20/13.33 | ns min | MCLK period: 50 MHz/75 MHz |
| t ₂ | 8/6 | ns min | MCLK high duration: 50 MHz/75 MHz |
| t ₃ | 8/6 | ns min | MCLK low duration: 50 MHz/75 MHz |
| t ₄ | 25 | ns min | SCLK period |
| t ₅ | 10 | ns min | SCLK high duration |
| t ₆ | 10 | ns min | SCLK low duration |
| t ₇ | 5 | ns min | FSYNC-to-SCLK falling edge setup time |
| t _{8 MIN} | 10 | ns min | FSYNC-to-SCLK hold time |
| t _{8 MAX} | t ₄ - 5 | ns max | |
| t ₉ | 5 | ns min | Data setup time |
| t ₁₀ | 3 | ns min | Data hold time |
| t ₁₁ | 8 | ns min | FSELECT, PSELECT setup time before MCLK rising edge |
| t _{11A} | 8 | ns min | FSELECT, PSELECT setup time after MCLK rising edge |
| t ₁₂ | 5 | ns min | SCLK high to FSYNC falling edge setup time |

¹ Guaranteed by design, not production tested.

Timing Diagrams

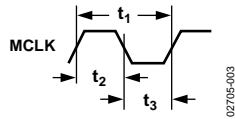

Figure 3. Master Clock

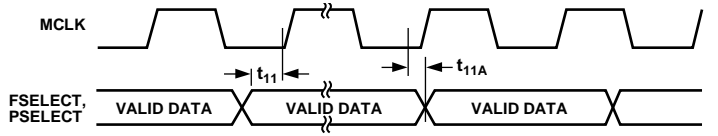

Figure 4. Control Timing

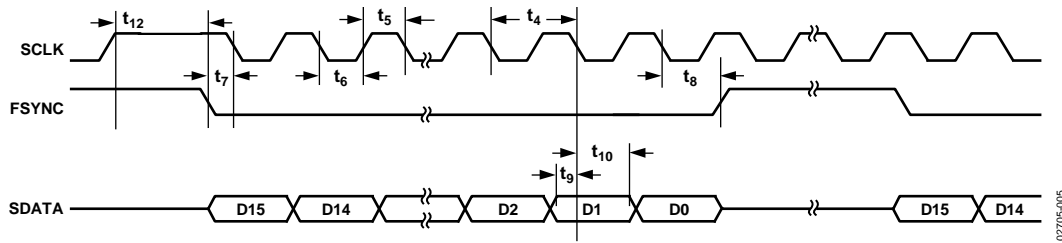

Figure 5. Serial Timing

ABSOLUTE MAXIMUM RATINGS

$T_A = 25^\circ\text{C}$, unless otherwise noted.

Table 3.

| Parameter | Ratings |
|--------------------------------------|------------------------|
| AVDD to AGND | -0.3 V to +6 V |
| DVDD to DGND | -0.3 V to +6 V |
| AGND to DGND | -0.3 V to +0.3 V |
| CAP/2.5V | 2.75 V |
| Digital I/O Voltage to DGND | -0.3 V to DVDD + 0.3 V |
| Analog I/O Voltage to AGND | -0.3 V to AVDD + 0.3 V |
| Operating Temperature Range | |
| Industrial (B Version) | -40°C to +105°C |
| Storage Temperature Range | -65°C to +150°C |
| Maximum Junction Temperature | 150°C |
| TSSOP Package | |
| θ_{JA} Thermal Impedance | 143°C/W |
| θ_{JC} Thermal Impedance | 45°C/W |
| Lead Temperature, Soldering (10 sec) | 300°C |
| IR Reflow, Peak Temperature | 220°C |
| Reflow Soldering (Pb-Free) | |
| Peak Temperature | 260°C (+0/-5) |
| Time at Peak Temperature | 10 sec to 40 sec |

Stresses above those listed under Absolute Maximum Ratings may cause permanent damage to the device. This is a stress rating only; functional operation of the device at these or any other conditions above those indicated in the operational section of this specification is not implied. Exposure to absolute maximum rating conditions for extended periods may affect device reliability.

ESD CAUTION



ESD (electrostatic discharge) sensitive device. Charged devices and circuit boards can discharge without detection. Although this product features patented or proprietary protection circuitry, damage may occur on devices subjected to high energy ESD. Therefore, proper ESD precautions should be taken to avoid performance degradation or loss of functionality.

PIN CONFIGURATION AND FUNCTION DESCRIPTIONS

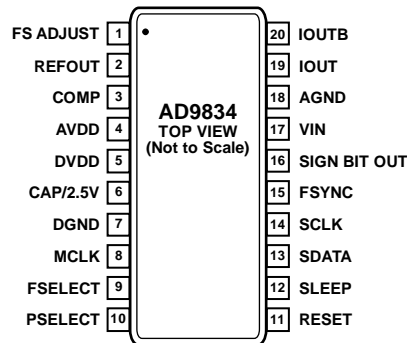

Figure 6. Pin Configuration

Table 4. Pin Function Descriptions

| Pin No. | Mnemonic | Description |
|-------------------------------|----------------|---|
| ANALOG SIGNAL AND REFERENCE | | |
| 1 | FS ADJUST | Full-Scale Adjust Control. A resistor (R_{SET}) is connected between this pin and AGND. This determines the magnitude of the full-scale DAC current. The relationship between R_{SET} and the full-scale current is as follows: $I_{OUT\ FULL\ SCALE} = 18 \times FSADJUST / R_{SET}$ $FSADJUST = 1.15\ V\ nominal, R_{SET} = 6.8\ k\Omega\ typical.$ |
| 2 | REFOUT | Voltage Reference Output. The AD9834 has an internal 1.20 V reference that is made available at this pin. |
| 3 | COMP | DAC Bias Pin. This pin is used for decoupling the DAC bias voltage. |
| 17 | VIN | Input to Comparator. The comparator can be used to generate a square wave from the sinusoidal DAC output. The DAC output should be filtered appropriately before being applied to the comparator to improve jitter. When Bit OPBITEN and Bit SIGN/PIB in the control register are set to 1, the comparator input is connected to VIN. |
| 19, 20 | IOUT, IOUTB | Current Output. This is a high impedance current source. A load resistor of nominally 200 Ω should be connected between IOUT and AGND. IOUTB should preferably be tied through an external load resistor of 200 Ω to AGND, but it can be tied directly to AGND. A 20 pF capacitor to AGND is also recommended to prevent clock feedthrough. |
| POWER SUPPLY | | |
| 4 | AVDD | Positive Power Supply for the Analog Section. AVDD can have a value from 2.3 V to 5.5 V. A 0.1 μ F decoupling capacitor should be connected between AVDD and AGND. |
| 5 | DVDD | Positive Power Supply for the Digital Section. DVDD can have a value from 2.3 V to 5.5 V. A 0.1 μ F decoupling capacitor should be connected between DVDD and DGND. |
| 6 | CAP/2.5V | The digital circuitry operates from a 2.5 V power supply. This 2.5 V is generated from DVDD using an on-board regulator (when DVDD exceeds 2.7 V). The regulator requires a decoupling capacitor of typically 100 nF that is connected from CAP/2.5 V to DGND. If DVDD is equal to or less than 2.7 V, CAP/2.5 V should be shorted to DVDD. |
| 7 | DGND | Digital Ground. |
| 18 | AGND | Analog Ground. |
| DIGITAL INTERFACE AND CONTROL | | |
| 8 | MCLK | Digital Clock Input. DDS output frequencies are expressed as a binary fraction of the frequency of MCLK. The output frequency accuracy and phase noise are determined by this clock. |
| 9 | FSELECT | Frequency Select Input. FSELECT controls which frequency register, FREQ0 or FREQ1, is used in the phase accumulator. The frequency register to be used can be selected using Pin FSELECT or Bit FSEL. When Bit FSEL is used to select the frequency register, the FSELECT pin should be tied to CMOS high or low. |
| 10 | PSELECT | Phase Select Input. PSELECT controls which phase register, PHASE0 or PHASE1, is added to the phase accumulator output. The phase register to be used can be selected using Pin PSELECT or Bit PSEL. When the phase registers are being controlled by Bit PSEL, the PSELECT pin should be tied to CMOS high or low. |
| 11 | RESET | Active High Digital Input. RESET resets appropriate internal registers to zero; this corresponds to an analog output of midscale. RESET does not affect any of the addressable registers. |
| 12 | SLEEP | Active High Digital Input. When this pin is high, the DAC is powered down. This pin has the same function as Control Bit SLEEP12. |

| Pin No. | Mnemonic | Description |
|---------|-----------------|---|
| 13 | SDATA | Serial Data Input. The 16-bit serial data-word is applied to this input. |
| 14 | SCLK | Serial Clock Input. Data is clocked into the AD9834 on each falling SCLK edge. |
| 15 | FSYNC | Active Low Control Input. This is the frame synchronization signal for the input data. When FSYNC is taken low, the internal logic is informed that a new word is being loaded into the device. |
| 16 | SIGN BIT OUT | Logic Output. The comparator output is available on this pin or, alternatively, the MSB from the NCO can be output on this pin. Setting Bit OPBITEN in the control register to 1 enables this output pin. Bit SIGN/PIB determines whether the comparator output or the MSB from the NCO is output on the pin. |

TYPICAL PERFORMANCE CHARACTERISTICS

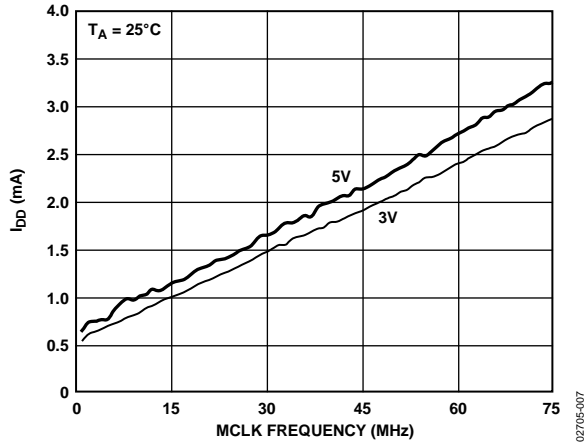

Figure 7. Typical Current Consumption (I_{DD}) vs. MCLK Frequency

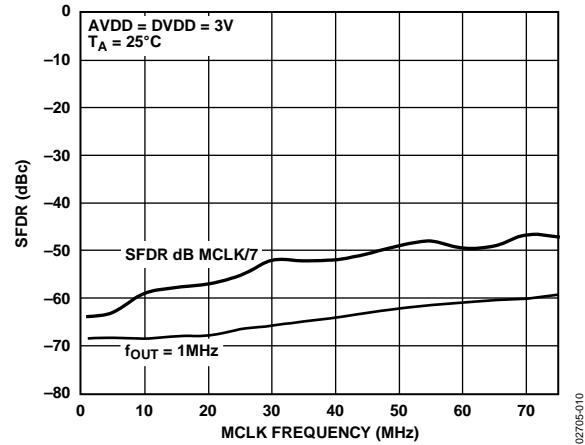

Figure 10. Wideband SFDR vs. MCLK Frequency

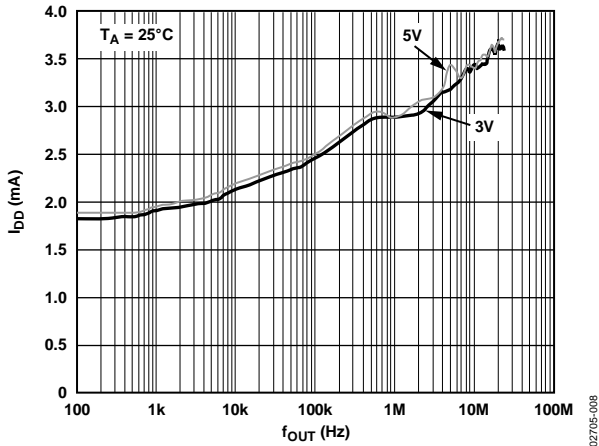

Figure 8. Typical I_{DD} vs. f_{OUT} for $f_{MCLK} = 50$ MHz

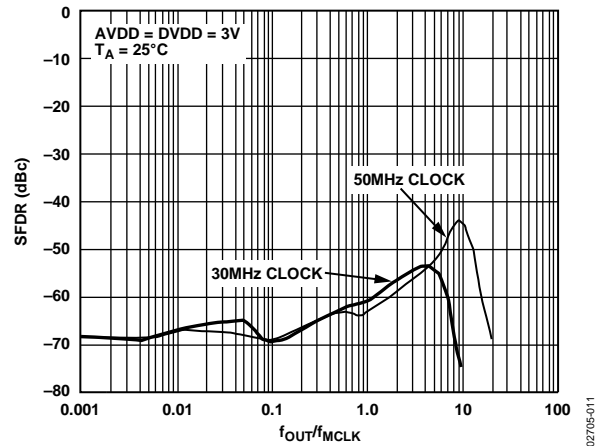

Figure 11. Wideband SFDR vs. f_{OUT}/f_{MCLK} for Various MCLK Frequencies

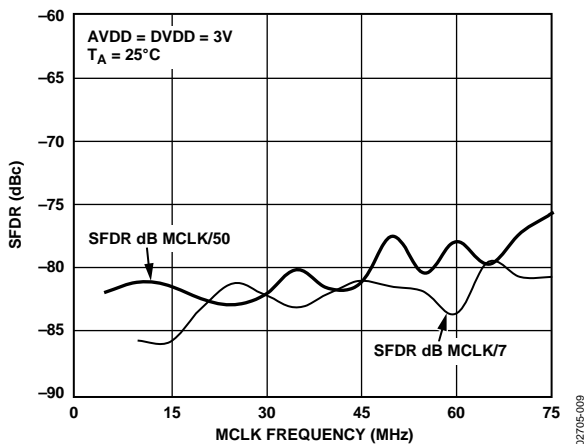

Figure 9. Narrow-Band SFDR vs. MCLK Frequency

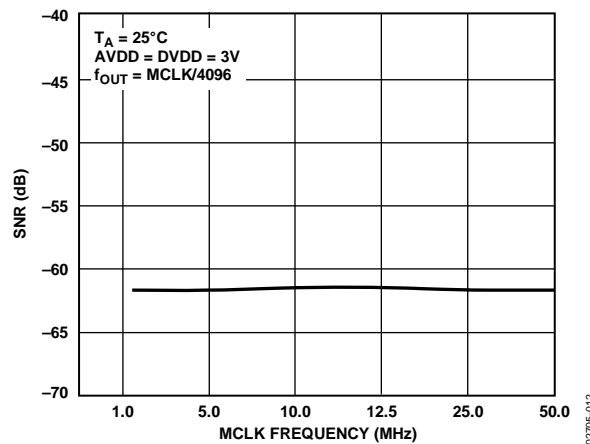

Figure 12. SNR vs. MCLK Frequency

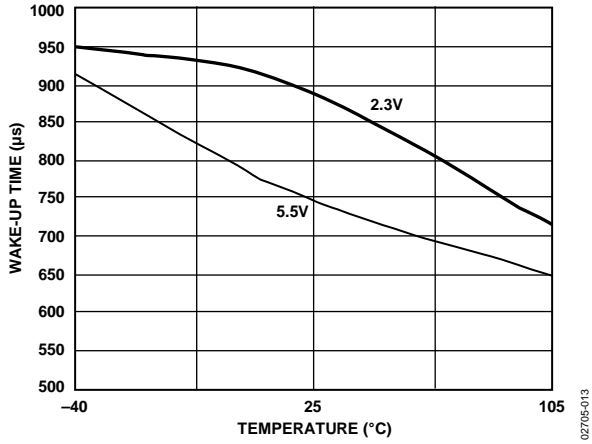

Figure 13. Wake-Up Time vs. Temperature

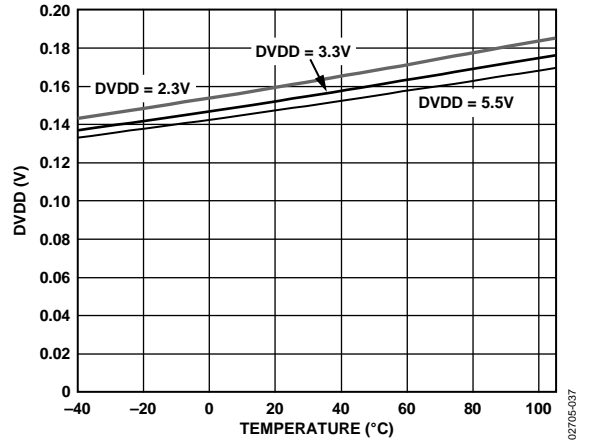

Figure 16. SIGN BIT OUT Low Level, $I_{SINK} = 1 \text{ mA}$

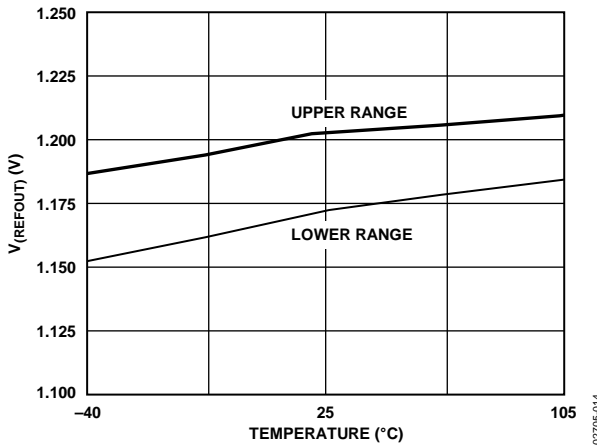

Figure 14. V_{REFOUT} vs. Temperature

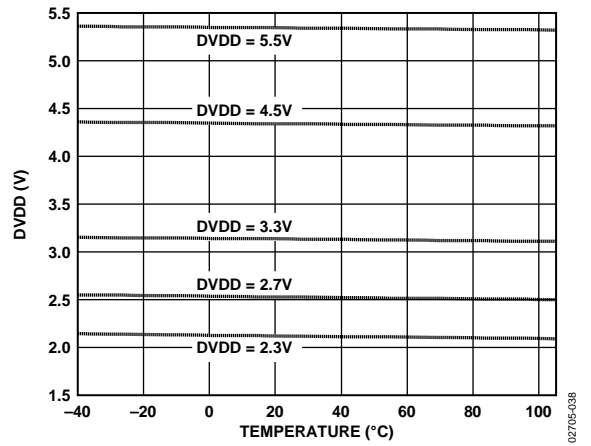

Figure 17. SIGN BIT OUT High Level, $I_{SINK} = 1 \text{ mA}$

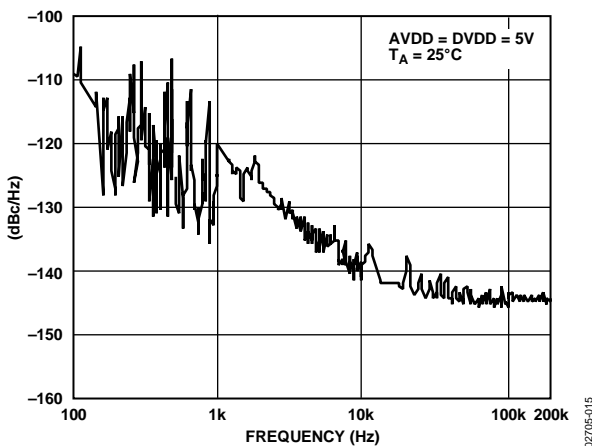

Figure 15. Output Phase Noise, $f_{OUT} = 2 \text{ MHz}$, $MCLK = 50 \text{ MHz}$

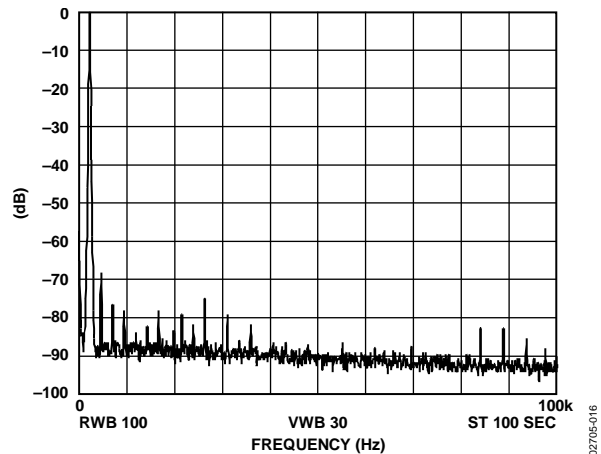

Figure 18. $f_{MCLK} = 10 \text{ MHz}$; $f_{OUT} = 2.4 \text{ kHz}$, Frequency Word = 000FBA9

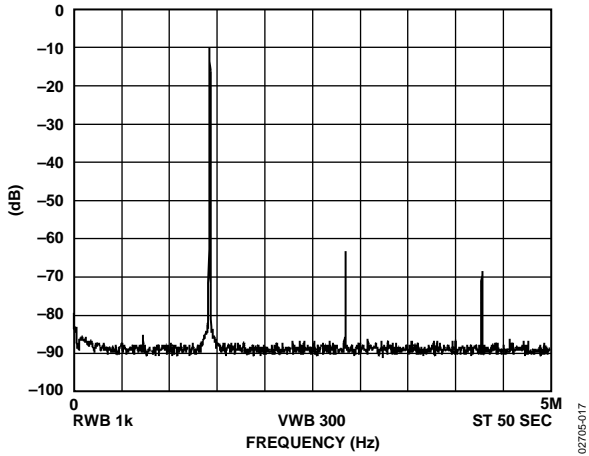

Figure 19. $f_{MCLK} = 10 \text{ MHz}$; $f_{OUT} = 1.43 \text{ MHz} = f_{MCLK}/7$,
Frequency Word = 2492492

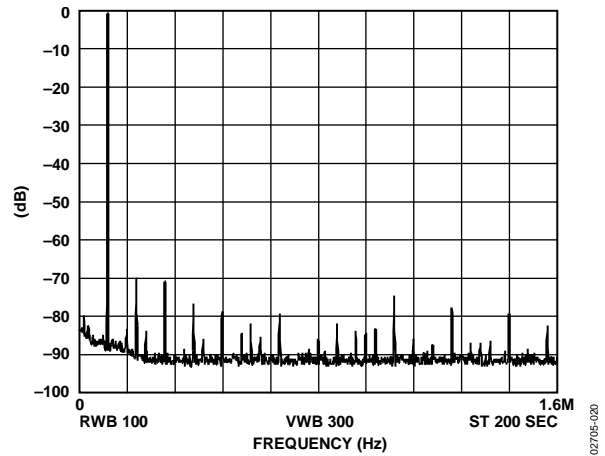

Figure 22. $f_{MCLK} = 50 \text{ MHz}$; $f_{OUT} = 120 \text{ kHz}$, Frequency Word = 009D496

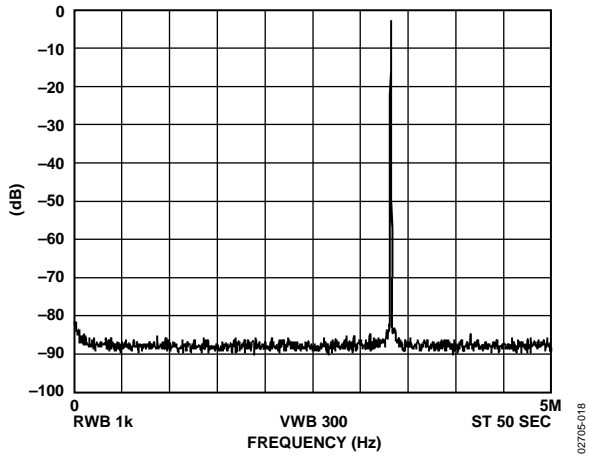

Figure 20. $f_{MCLK} = 10 \text{ MHz}$; $f_{OUT} = 3.33 \text{ MHz} = f_{MCLK}/3$,
Frequency Word = 5555555

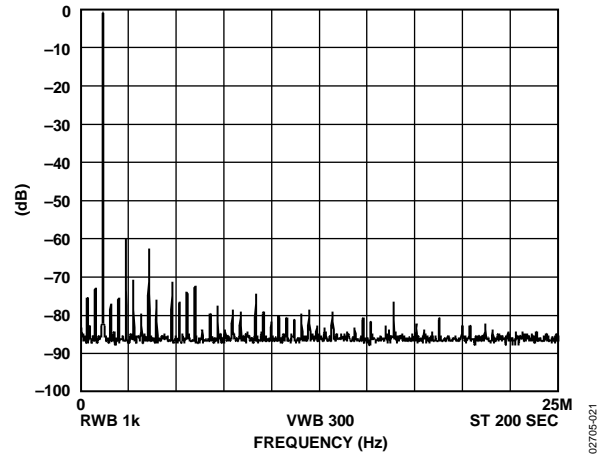

Figure 23. $f_{MCLK} = 50 \text{ MHz}$; $f_{OUT} = 1.2 \text{ MHz}$, Frequency Word = 0624DD3

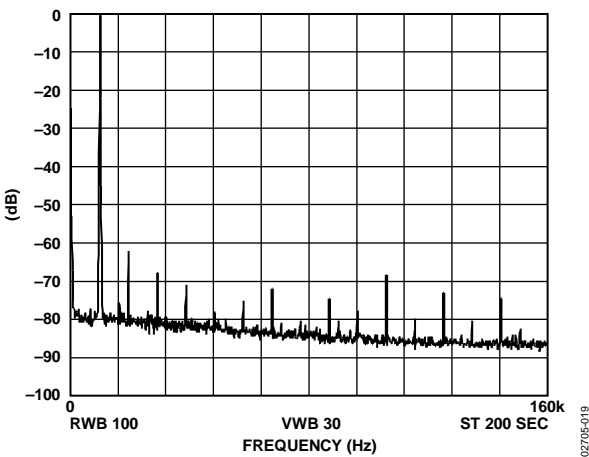

Figure 21. $f_{MCLK} = 50 \text{ MHz}$; $f_{OUT} = 12 \text{ kHz}$, Frequency Word = 000FBA9

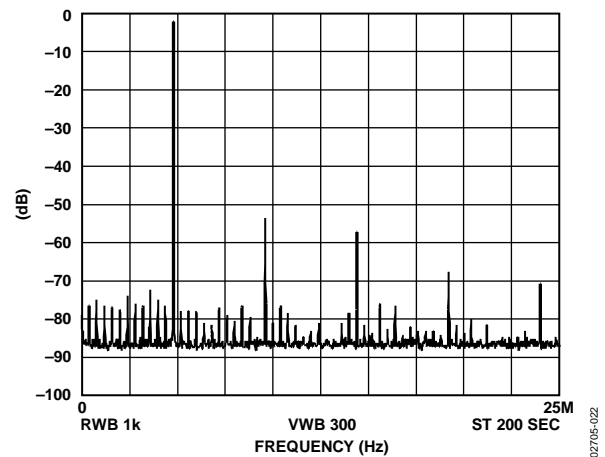

Figure 24. $f_{MCLK} = 50 \text{ MHz}$; $f_{OUT} = 4.8 \text{ MHz}$, Frequency Word = 189374C

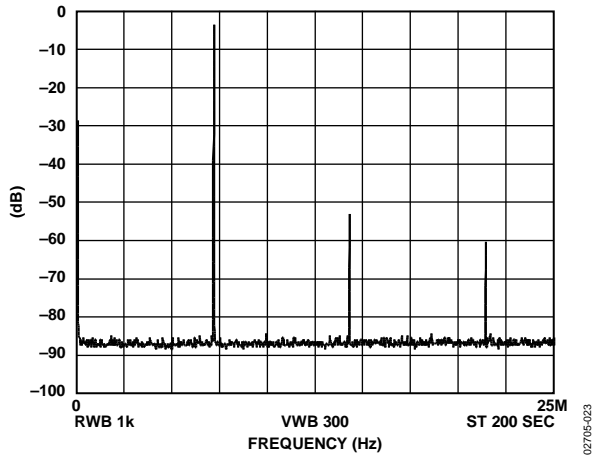

Figure 25. $f_{MCLK} = 50 \text{ MHz}$; $f_{OUT} = 7.143 \text{ MHz} = f_{MCLK}/7$,
Frequency Word = 2492492

02705-023

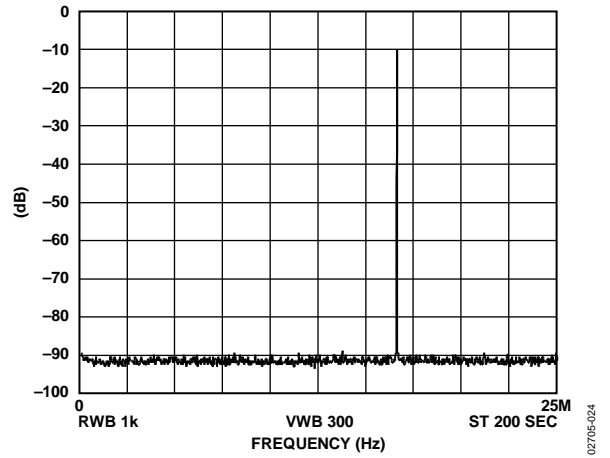

Figure 26. $f_{MCLK} = 50 \text{ MHz}$; $f_{OUT} = 16.667 \text{ MHz} = f_{MCLK}/3$,
Frequency Word = 5555555

02705-024

TERMINOLOGY

Integral Nonlinearity (INL)

INL is the maximum deviation of any code from a straight line passing through the endpoints of the transfer function. The endpoints of the transfer function are zero scale, a point 0.5 LSB below the first code transition (000 . . . 00 to 000 . . . 01), and full scale, a point 0.5 LSB above the last code transition (111 . . . 10 to 111 . . . 11). The error is expressed in LSBs.

Differential Nonlinearity (DNL)

DNL is the difference between the measured and ideal 1 LSB change between two adjacent codes in the DAC. A specified DNL of ± 1 LSB maximum ensures monotonicity.

Output Compliance

The output compliance refers to the maximum voltage that can be generated at the output of the DAC to meet the specifications. When voltages greater than that specified for the output compliance are generated, the [AD9834](#) may not meet the specifications listed in the data sheet.

Spurious-Free Dynamic Range (SFDR)

Along with the frequency of interest, harmonics of the fundamental frequency and images of these frequencies are present at the output of a DDS device. The SFDR refers to the largest spur or harmonic present in the band of interest. The wideband SFDR gives the magnitude of the largest harmonic or

spur relative to the magnitude of the fundamental frequency in the 0 to Nyquist bandwidth. The narrow-band SFDR gives the attenuation of the largest spur or harmonic in a bandwidth of ± 200 kHz about the fundamental frequency.

Total Harmonic Distortion (THD)

THD is the ratio of the rms sum of harmonics to the rms value of the fundamental. For the [AD9834](#), THD is defined as

$$THD = 20 \log \sqrt{\frac{V_2^2 + V_3^2 + V_4^2 + V_5^2 + V_6^2}{V_1^2}}$$

where V_1 is the rms amplitude of the fundamental and V_2 , V_3 , V_4 , V_5 , and V_6 are the rms amplitudes of the second harmonic through the sixth harmonic.

Signal-to-Noise Ratio (SNR)

SNR is the ratio of the rms value of the measured output signal to the rms sum of all other spectral components below the Nyquist frequency. The value for SNR is expressed in decibels.

Clock Feedthrough

There is feedthrough from the MCLK input to the analog output. Clock feedthrough refers to the magnitude of the MCLK signal relative to the fundamental frequency in the output spectrum of the [AD9834](#).

THEORY OF OPERATION

Sine waves are typically thought of in terms of their magnitude form $a(t) = \sin(\omega t)$. However, these are nonlinear and not easy to generate except through piecewise construction. On the other hand, the angular information is linear in nature, that is, the phase angle rotates through a fixed angle for each unit of time. The angular rate depends on the frequency of the signal by the traditional rate of $\omega = 2\pi f$.

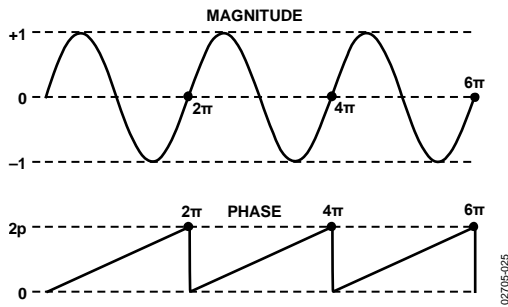

Figure 27. Sine Wave

Knowing that the phase of a sine wave is linear and given a reference interval (clock period), the phase rotation for that period can be determined.

$$\Delta Phase = \omega \Delta t$$

Solving for ω ,

$$\omega = \Delta Phase / \Delta t = 2\pi f$$

Solving for f and substituting the reference clock frequency for the reference period ($1/f_{MCLK} = \Delta t$),

$$f = \Delta Phase \times f_{MCLK} / 2\pi$$

The AD9834 builds the output based on this simple equation. A simple DDS chip can implement this equation with three major subcircuits: numerically controlled oscillator + phase modulator, SIN ROM, and digital-to-analog converter (DAC). Each of these subcircuits is discussed in the Circuit Description section.

CIRCUIT DESCRIPTION

The [AD9834](#) is a fully integrated direct digital synthesis (DDS) chip. The chip requires one reference clock, one low precision resistor, and eight decoupling capacitors to provide digitally created sine waves up to 37.5 MHz. In addition to the generation of this RF signal, the chip is fully capable of a broad range of simple and complex modulation schemes. These modulation schemes are fully implemented in the digital domain, allowing accurate and simple realization of complex modulation algorithms using DSP techniques.

The internal circuitry of the [AD9834](#) consists of the following main sections: a numerically controlled oscillator (NCO), frequency and phase modulators, SIN ROM, a DAC, a comparator, and a regulator.

NUMERICALLY CONTROLLED OSCILLATOR PLUS PHASE MODULATOR

This consists of two frequency select registers, a phase accumulator, two phase offset registers, and a phase offset adder. The main component of the NCO is a 28-bit phase accumulator. Continuous time signals have a phase range of 0π to 2π . Outside this range of numbers, the sinusoid functions repeat themselves in a periodic manner. The digital implementation is no different. The accumulator simply scales the range of phase numbers into a multibit digital word. The phase accumulator in the [AD9834](#) is implemented with 28 bits. Therefore, in the [AD9834](#), $2\pi = 2^{28}$. Likewise, the ΔPhase term is scaled into this range of numbers:

$$0 < \Delta\text{Phase} < 2^{28} - 1.$$

Making these substitutions into the previous equation

$$f = \Delta\text{Phase} \times f_{\text{MCLK}} / 2^{28}$$

where $0 < \Delta\text{Phase} < 2^{28} - 1$.

The input to the phase accumulator can be selected either from the `FREQ0` register or `FREQ1` register and is controlled by the `FSELECT` pin or the `FSEL` bit. NCOs inherently generate continuous phase signals, thus avoiding any output discontinuity when switching between frequencies.

Following the NCO, a phase offset can be added to perform phase modulation using the 12-bit phase registers. The contents of one of these phase registers is added to the MSBs of the NCO. The [AD9834](#) has two phase registers, the resolution of these registers being $2\pi/4096$.

SIN ROM

To make the output from the NCO useful, it must be converted from phase information into a sinusoidal value. Phase information maps directly into amplitude; therefore, the SIN ROM uses the digital phase information as an address to a look-up table and converts the phase information into amplitude.

Although the NCO contains a 28-bit phase accumulator, the output of the NCO is truncated to 12 bits. Using the full resolution of the phase accumulator is impractical and unnecessary because it requires a look-up table of 2^{28} entries. It is necessary only to have sufficient phase resolution such that the errors due to truncation are smaller than the resolution of the 10-bit DAC. This requires the SIN ROM to have two bits of phase resolution more than the 10-bit DAC.

The SIN ROM is enabled using the `OPBITEN` and `MODE` bits in the control register. This is explained further in Table 18.

DIGITAL-TO-ANALOG CONVERTER (DAC)

The [AD9834](#) includes a high impedance current source 10-bit DAC capable of driving a wide range of loads. The full-scale output current can be adjusted for optimum power and external load requirements using a single external resistor (R_{SET}).

The DAC can be configured for either single-ended or differential operation. `IOUT` and `IOUTB` can be connected through equal external resistors to `AGND` to develop complementary output voltages. The load resistors can be any value required, as long as the full-scale voltage developed across it does not exceed the voltage compliance range. Because full-scale current is controlled by R_{SET} , adjustments to R_{SET} can balance changes made to the load resistors.

COMPARATOR

The [AD9834](#) can be used to generate synthesized digital clock signals. This is accomplished by using the on-board self-biasing comparator that converts the sinusoidal signal of the DAC to a square wave. The output from the DAC can be filtered externally before being applied to the comparator input. The comparator reference voltage is the time average of the signal applied to V_{IN} . The comparator can accept signals in the range of approximately 100 mV p-p to 1 V p-p. As the comparator input is ac-coupled, to operate correctly as a zero crossing detector, it requires a minimum input frequency of typically 3 MHz. The comparator output is a square wave with an amplitude from 0 V to `DVDD`.

The AD9834 is a sampled signal with its output following Nyquist sampling theorem. Specifically, its output spectrum contains the fundamental plus aliased signals (images) that occur at multiples of the reference clock frequency and the selected output frequency. A graphical representation of the sampled spectrum, with aliased images, is shown in Figure 28.

The prominence of the aliased images is dependent on the ratio of f_{OUT} to MCLK. If ratio is small, the aliased images are very prominent and of a relatively high energy level as determined by the $\sin(x)/x$ roll-off of the quantized DAC output. In fact, depending on the f_{OUT} /reference clock relationship, the first aliased image can be on the order of -3 dB below the fundamental.

A low-pass filter is generally placed between the output of the DAC and the input of the comparator to further suppress the effects of aliased images. Obviously, consideration must be given to the relationship of the selected output frequency and the reference clock frequency to avoid unwanted (and unexpected) output anomalies. To apply the AD9834 as a clock generator, limit the selected output frequency to $<33\%$ of reference clock frequency, and thereby avoid generating aliased signals that fall within, or close to, the output band of interest (generally dc-selected output frequency). This practice eases the complexity (and cost) of the external filter requirement for the clock generator application. Refer to the [AN-837 Application Note](#) for more information.

To enable the comparator, Bit SIGN/PIB and Bit OPBITEN in the control register are set to 1. This is explained further in Table 17.

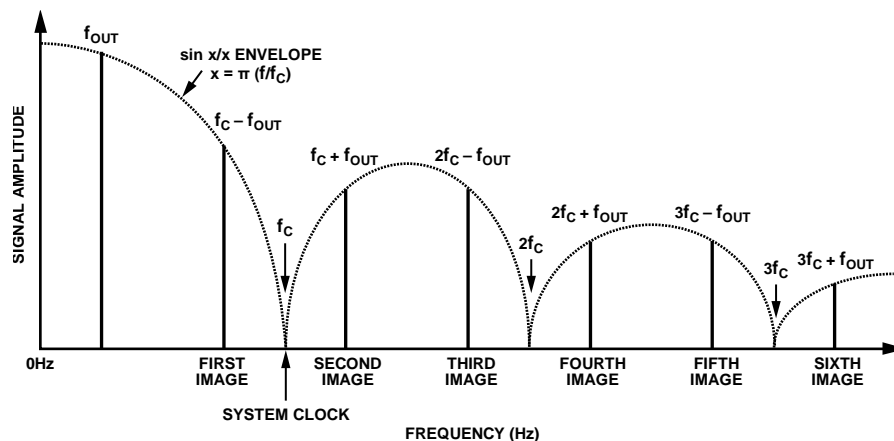

Figure 28. The DAC Output Spectrum

REGULATOR

The AD9834 has separate power supplies for the analog and digital sections. AVDD provides the power supply required for the analog section, and DVDD provides the power supply for the digital section. Both of these supplies can have a value of 2.3 V to 5.5 V and are independent of each other. For example, the analog section can be operated at 5 V, and the digital section can be operated at 3 V, or vice versa.

The internal digital section of the AD9834 is operated at 2.5 V. An on-board regulator steps down the voltage applied at DVDD to 2.5 V. The digital interface (serial port) of the AD9834 also operates from DVDD. These digital signals are level shifted within the AD9834 to make them 2.5 V compatible.

When the applied voltage at the DVDD pin of the AD9834 is equal to or less than 2.7 V, Pin CAP/2.5V and Pin DVDD should be tied together, thus bypassing the on-board regulator.

OUTPUT VOLTAGE COMPLIANCE

The AD9834 has a maximum current density, set by the R_{SET} , of 4 mA. The maximum output voltage from the AD9834 is $V_{DD} - 1.5$ V. This is to ensure that the output impedance of the internal switch does not change, affecting the spectral performance of the part. For a minimum supply of 2.3 V, the maximum output voltage is 0.8 V. Specifications in Table 1 are guaranteed with an R_{SET} of 6.8 k Ω and an R_{LOAD} of 200 Ω .

FUNCTIONAL DESCRIPTION

SERIAL INTERFACE

The AD9834 has a standard 3-wire serial interface that is compatible with SPI, QSPI™, MICROWIRE™, and DSP interface standards.

Data is loaded into the device as a 16-bit word under the control of a serial clock input (SCLK). The timing diagram for this operation is given in Figure 5.

For a detailed example of programming the AD9833 and AD9834 devices, refer to the AN-1070 Application Note.

The FSYNC input is a level triggered input that acts as a frame synchronization and chip enable. Data can only be transferred into the device when FSYNC is low. To start the serial data transfer, FSYNC should be taken low, observing the minimum FSYNC-to-SCLK falling edge setup time (t_7). After FSYNC goes low, serial data is shifted into the input shift register of the device on the falling edges of SCLK for 16 clock pulses. FSYNC can be taken high after the 16th falling edge of SCLK, observing the minimum SCLK falling edge to FSYNC rising edge time (t_8). Alternatively, FSYNC can be kept low for a multiple of 16 SCLK pulses and then brought high at the end of the data transfer. In this way, a continuous stream of 16-bit words can be loaded while FSYNC is held low, with FSYNC only going high after the 16th SCLK falling edge of the last word is loaded.

The SCLK can be continuous, or alternatively, the SCLK can idle high or low between write operations but must be high when FSYNC goes low (t_{12}).

POWERING UP THE AD9834

The flow chart in Figure 31 shows the operating routine for the AD9834. When the AD9834 is powered up, the part should be reset. This resets appropriate internal registers to 0 to provide an analog output of midscale. To avoid spurious DAC outputs during AD9834 initialization, the RESET bit/pin should be set to 1 until the part is ready to begin generating an output. RESET does not reset the phase, frequency, or control registers. These registers contain invalid data, and, therefore, should be set to a known value by the user. The RESET bit/pin should then be set

to 0 to begin generating an output. The data appears on the DAC output eight MCLK cycles after RESET is set to 0.

LATENCY

Latency is associated with each operation. When Pin FSELECT and Pin PSELECT change value, there is a pipeline delay before control is transferred to the selected register. When the t_{11} and t_{11A} timing specifications are met (see Figure 4), FSELECT and PSELECT have latencies of eight MCLK cycles. When the t_{11} and t_{11A} timing specifications are not met, the latency is increased by one MCLK cycle.

Similarly, there is a latency associated with each asynchronous write operation. If a selected frequency/phase register is loaded with a new word, there is a delay of eight to nine MCLK cycles before the analog output changes. There is an uncertainty of one MCLK cycle because it depends on the position of the MCLK rising edge when the data is loaded into the destination register.

The negative transition of the RESET and SLEEP functions are sampled on the internal falling edge of MCLK. Therefore, they also have a latency associated with them.

CONTROL REGISTER

The AD9834 contains a 16-bit control register that sets up the AD9834 as the user wants to operate it. All control bits, except MODE, are sampled on the internal negative edge of MCLK. Table 6 describes the individual bits of the control register. The different functions and the various output options from the AD9834 are described in more detail in the Frequency and Phase Registers section.

To inform the AD9834 that the contents of the control register are to be altered, DB15 and DB14 must be set to 0 as shown in Table 5.

Table 5. Control Register

| DB15 | DB14 | DB13 . . . DB0 |
|------|------|----------------|
| 0 | 0 | CONTROL bits |

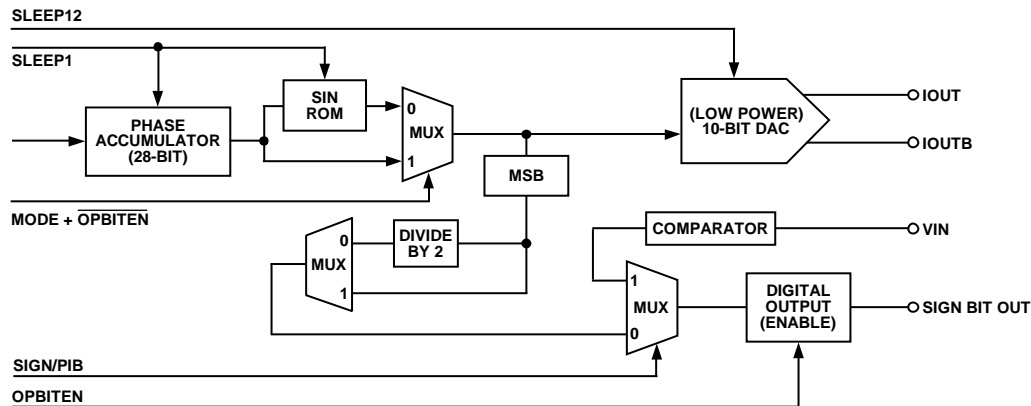

Figure 29. Function of Control Bits

027705-026

| | | | | | | | | | | | | | | | |
|------|------|------|------|------|------|--------|-------|--------|---------|---------|----------|------|-----|------|-----|
| DB15 | DB14 | DB13 | DB12 | DB11 | DB10 | DB9 | DB8 | DB7 | DB6 | DB5 | DB4 | DB3 | DB2 | DB1 | DB0 |
| 0 | 0 | B28 | HLB | FSEL | PSEL | PIN/SW | RESET | SLEEP1 | SLEEP12 | OPBITEN | SIGN/PIB | DIV2 | 0 | MODE | 0 |

Table 6. Description of Bits in the Control Register

| Bit | Name | Description |
|------|---------|--|
| DB13 | B28 | Two write operations are required to load a complete word into either of the frequency registers. B28 = 1 allows a complete word to be loaded into a frequency register in two consecutive writes. The first write contains the 14 LSBs of the frequency word and the next write contains the 14 MSBs. The first two bits of each 16-bit word define the frequency register the word is loaded to and should, therefore, be the same for both of the consecutive writes. Refer to Table 10 for the appropriate addresses. The write to the frequency register occurs after both words have been loaded. An example of a complete 28-bit write is shown in Table 11. Note however, that consecutive 28-bit writes to the same frequency register are not allowed, switch between frequency registers to do this type of function. B28 = 0, the 28-bit frequency register operates as two 14-bit registers, one containing the 14 MSBs and the other containing the 14 LSBs. This means that the 14 MSBs of the frequency word can be altered independent of the 14 LSBs, and vice versa. To alter the 14 MSBs or the 14 LSBs, a single write is made to the appropriate frequency address. The Control Bit DB12 (HLB) informs the AD9834 whether the bits to be altered are the 14 MSBs or 14 LSBs. |
| DB12 | HLB | This control bit allows the user to continuously load the MSBs or LSBs of a frequency register ignoring the remaining 14 bits. This is useful if the complete 28-bit resolution is not required. HLB is used in conjunction with DB13 (B28). This control bit indicates whether the 14 bits being loaded are being transferred to the 14 MSBs or 14 LSBs of the addressed frequency register. DB13 (B28) must be set to 0 to be able to change the MSBs and LSBs of a frequency word separately. When DB13 (B28) = 1, this control bit is ignored. HLB = 1 allows a write to the 14 MSBs of the addressed frequency register. HLB = 0 allows a write to the 14 LSBs of the addressed frequency register. |
| DB11 | FSEL | The FSEL bit defines whether the FREQ0 register or the FREQ1 register is used in the phase accumulator. See Table 8 to select a frequency register. |
| DB10 | PSEL | The PSEL bit defines whether the PHASE0 register data or the PHASE1 register data is added to the output of the phase accumulator. See Table 9 to select a phase register. |
| DB9 | PIN/SW | Functions that select frequency and phase registers, reset internal registers, and power down the DAC can be implemented using either software or hardware. PIN/SW selects the source of control for these functions. PIN/SW = 1 implies that the functions are being controlled using the appropriate control pins. PIN/SW = 0 implies that the functions are being controlled using the appropriate control bits. |
| DB8 | RESET | RESET = 1 resets internal registers to 0, this corresponds to an analog output of midscale. RESET = 0 disables RESET. This function is explained in the RESET Function section. |
| DB7 | SLEEP1 | SLEEP1 = 1, the internal MCLK is disabled. The DAC output remains at its present value as the NCO is no longer accumulating. SLEEP1 = 0, MCLK is enabled. This function is explained in the SLEEP Function section. |
| DB6 | SLEEP12 | SLEEP12 = 1 powers down the on-chip DAC. This is useful when the AD9834 is used to output the MSB of the DAC data. SLEEP12 = 0 implies that the DAC is active. This function is explained in the SLEEP Function section. |

| Bit | Name | Description |
|-----|----------|--|
| DB5 | OPBITEN | The function of this bit is to control whether there is an output at the SIGN BIT OUT pin. This bit should remain at 0 if the user is not using the SIGN BIT OUT pin. OPBITEN = 1 enables the SIGN BIT OUT pin. OPBITEN = 0, the SIGN BIT OUT output buffer is put into a high impedance state, therefore no output is available at the SIGN BIT OUT pin. |
| DB4 | SIGN/PIB | The function of this bit is to control what is output at the SIGN BIT OUT pin. SIGN/PIB = 1, the on-board comparator is connected to SIGN BIT OUT. After filtering the sinusoidal output from the DAC, the waveform can be applied to the comparator to generate a square waveform. Refer to Table 17. SIGN/PIB = 0, the MSB (or MSB/2) of the DAC data is connected to the SIGN BIT OUT pin. Bit DIV2 controls whether it is the MSB or MSB/2 that is output. |
| DB3 | DIV2 | DIV2 is used in association with SIGN/PIB and OPBITEN. Refer to Table 17. DIV2 = 1, the digital output is passed directly to the SIGN BIT OUT pin. DIV2 = 0, the digital output/2 is passed directly to the SIGN BIT OUT pin. |
| DB2 | Reserved | This bit must always be set to 0. |
| DB1 | MODE | The function of this bit is to control what is output at the IOUT pin/IOUTB pin. This bit should be set to 0 if the Control Bit OPBITEN = 1. MODE = 1, the SIN ROM is bypassed, resulting in a triangle output from the DAC. MODE = 0, the SIN ROM is used to convert the phase information into amplitude information, resulting in a sinusoidal signal at the output. See Table 18. |
| DB0 | Reserved | This bit must always be set to 0. |

FREQUENCY AND PHASE REGISTERS

The AD9834 contains two frequency registers and two phase registers. These are described in Table 7.

Table 7. Frequency/Phase Registers

| Register | Size | Description |
|----------|---------|---|
| FREQ0 | 28 bits | Frequency Register 0. When either the FSEL bit or FSELECT pin = 0, this register defines the output frequency as a fraction of the MCLK frequency. |
| FREQ1 | 28 bits | Frequency Register 1. When either the FSEL bit or FSELECT pin = 1, this register defines the output frequency as a fraction of the MCLK frequency. |
| PHASE0 | 12 bits | Phase Offset Register 0. When either the PSEL bit or PSELECT pin = 0, the contents of this register are added to the output of the phase accumulator. |
| PHASE1 | 12 bits | Phase Offset Register 1. When either the PSEL bit or PSELECT pin = 1, the contents of this register are added to the output of the phase accumulator. |

The analog output from the AD9834 is

$$f_{MCLK}/2^{28} \times FREQREG$$

where *FREQREG* is the value loaded into the selected frequency register. This signal is phase shifted by

$$2\pi/4096 \times PHASEREG$$

where *PHASEREG* is the value contained in the selected phase register. Consideration must be given to the relationship of the selected output frequency and the reference clock frequency to avoid unwanted output anomalies.

Access to the frequency and phase registers is controlled by both the FSELECT and PSELECT pins, and the FSEL and PSEL control bits. If the Control Bit PIN/SW = 1, the pins control the function; whereas, if PIN/SW = 0, the bits control the function. This is outlined in Table 8 and Table 9. If the FSEL and PSEL bits are used, the pins should be held at CMOS logic high or low. Control of the frequency/phase registers is interchangeable from the pins to the bits.

Table 8. Selecting a Frequency Register

| FSELECT | FSEL | PIN/SW | Selected Register |
|---------|------|--------|-------------------|
| 0 | X | 1 | FREQ0 REG |
| 1 | X | 1 | FREQ1 REG |
| X | 0 | 0 | FREQ0 REG |
| X | 1 | 0 | FREQ1 REG |

Table 9. Selecting a Phase Register

| PSELECT | PSEL | PIN/SW | Selected Register |
|---------|------|--------|-------------------|
| 0 | X | 1 | PHASE0 REG |
| 1 | X | 1 | PHASE1 REG |
| X | 0 | 0 | PHASE0 REG |
| X | 1 | 0 | PHASE1 REG |

The FSELECT pin and PSELECT pin are sampled on the internal falling edge of MCLK. It is recommended that the data on these pins does not change within a time window of the falling edge of MCLK (see Figure 4 for timing). If FSELECT or PSELECT changes value when a falling edge occurs, there is an uncertainty of one MCLK cycle because it pertains to when control is transferred to the other frequency/phase register.

The flow charts in Figure 32 and Figure 33 show the routine for selecting and writing to the frequency and phase registers of the AD9834.

WRITING TO A FREQUENCY REGISTER

When writing to a frequency register, Bit DB15 and Bit DB14 give the address of the frequency register.

Table 10. Frequency Register Bits

| DB15 | DB14 | DB13 . . . DB0 |
|------|------|-------------------|
| 0 | 1 | 14 FREQ0 REG BITS |
| 1 | 0 | 14 FREQ1 REG BITS |

If the user wants to alter the entire contents of a frequency register, two consecutive writes to the same address must be performed because the frequency registers are 28 bits wide. The first write contains the 14 LSBs, and the second write contains the 14 MSBs. For this mode of operation, Control Bit B28 (DB13) should be set to 1. An example of a 28-bit write is shown in Table 11.

Note however that continuous writes to the same frequency register are not recommended. This results in intermediate updates during the writes. If a frequency sweep, or something similar, is required, it is recommended that users alternate between the two frequency registers.

Table 11. Writing FFFC000 to FREQ0 REG

| SDATA Input | Result of Input Word |
|---------------------|--|
| 0010 0000 0000 0000 | Control word write (DB15, DB14 = 00), B28 (DB13) = 1, HLB (DB12) = X |
| 0100 0000 0000 0000 | FREQ0 REG write (DB15, DB14 = 01), 14 LSBs = 0000 |
| 0111 1111 1111 1111 | FREQ0 REG write (DB15, DB14 = 01), 14 MSBs = 3FFF |

In some applications, the user does not need to alter all 28 bits of the frequency register. With coarse tuning, only the 14 MSBs are altered; though with fine tuning only the 14 LSBs are altered. By setting Control Bit B28 (DB13) to 0, the 28-bit frequency register operates as two 14-bit registers, one containing the 14 MSBs and the other containing the 14 LSBs. This means that the 14 MSBs of the frequency word can be altered independent of the 14 LSBs, and vice versa. Bit HLB (DB12) in the control register identifies the 14 bits that are being altered. Examples of this are shown in Table 12 and Table 13.

Table 12. Writing 3FFF to the 14 LSBs of FREQ1 REG

| SDATA Input | Result of Input Word |
|---------------------|---|
| 0000 0000 0000 0000 | Control word write (DB15, DB14 = 00), B28 (DB13) = 0, HLB (DB12) = 0, that is, LSBs |
| 1011 1111 1111 1111 | FREQ1 REG write (DB15, DB14 = 10), 14 LSBs = 3FFF |

Table 13. Writing 00FF to the 14 MSBs of FREQ0 REG

| SDATA Input | Result of Input Word |
|---------------------|---|
| 0001 0000 0000 0000 | Control word write (DB15, DB14 = 00), B28 (DB13) = 0, HLB (DB12) = 1, that is, MSBs |
| 0100 0000 1111 1111 | FREQ0 REG write (DB15, DB14 = 01), 14 MSBs = 00FF |

WRITING TO A PHASE REGISTER

When writing to a phase register, Bit DB15 and Bit DB14 are set to 11. Bit DB13 identifies which phase register is being loaded.

Table 14. Phase Register Bits

| DB15 | DB14 | DB13 | DB12 | DB11 | DB0 |
|------|------|------|------|--------------------|-----|
| 1 | 1 | 0 | X | MSB 12 PHASE0 bits | LSB |
| 1 | 1 | 1 | X | MSB 12 PHASE1 bits | LSB |

RESET FUNCTION

The RESET function resets appropriate internal registers to 0 to provide an analog output of midscale. RESET does not reset the phase, frequency, or control registers.

When the AD9834 is powered up, the part should be reset. To reset the AD9834, set the RESET pin/bit to 1. To take the part out of reset, set the pin/bit to 0. A signal appears at the DAC output seven MCLK cycles after RESET is set to 0.

The RESET function is controlled by both the RESET pin and the RESET control bit. If the Control Bit PIN/SW = 0, the RESET bit controls the function, whereas if PIN/SW = 1, the RESET pin controls the function.

Table 15. Applying RESET

| RESET Pin | RESET Bit | PIN/SW Bit | Result |
|-----------|-----------|------------|--------------------------|
| 0 | X | 1 | No reset applied |
| 1 | X | 1 | Internal registers reset |
| X | 0 | 0 | No reset applied |
| X | 1 | 0 | Internal registers reset |

The effect of asserting the RESET pin is evident immediately at the output, that is, the zero-to-one transition of this pin is not sampled. However, the negative transition of RESET is sampled on the internal falling edge of MCLK.

SLEEP FUNCTION

Sections of the AD9834 that are not in use can be powered down to minimize power consumption by using the SLEEP function. The parts of the chip that can be powered down are the internal clock and the DAC. The DAC can be powered down through hardware or software. The pin/bits required for the SLEEP function are outlined in Table 16.

Table 16. Applying the SLEEP Function

| SLEEP Pin | SLEEP1 Bit | SLEEP12 Bit | PIN/SW Bit | Result |
|-----------|------------|-------------|------------|---|
| 0 | X | X | 1 | No power-down |
| 1 | X | X | 1 | DAC powered down |
| X | 0 | 0 | 0 | No power-down |
| X | 0 | 1 | 0 | DAC powered down |
| X | 1 | 0 | 0 | Internal clock disabled |
| X | 1 | 1 | 0 | Both the DAC powered down and the internal clock disabled |

DAC Powered Down

This is useful when the AD9834 is used to output the MSB of the DAC data only. In this case, the DAC is not required and can be powered down to reduce power consumption.

Internal Clock Disabled

When the internal clock of the AD9834 is disabled, the DAC output remains at its present value because the NCO is no longer accumulating. New frequency, phase, and control words can be written to the part when the SLEEP1 control bit is active. The synchronizing clock remains active, meaning that the selected frequency and phase registers can also be changed either at the pins or by using the control bits. Setting the SLEEP1 bit to 0 enables the MCLK. Any changes made to the registers when SLEEP1 is active are observed at the output after a certain latency.

The effect of asserting the SLEEP pin is evident immediately at the output, that is, the zero-to-one transition of this pin is not sampled. However, the negative transition of SLEEP is sampled on the internal falling edge of MCLK.

SIGN BIT OUT PIN

The AD9834 offers a variety of outputs from the chip. The digital outputs are available from the SIGN BIT OUT pin. The available outputs are the comparator output or the MSB of the DAC data. The bits controlling the SIGN BIT OUT pin are outlined in Table 17.

This pin must be enabled before use. The enabling/disabling of this pin is controlled by the Bit OPBITEN (DB5) in the control register. When OPBITEN = 1, this pin is enabled. Note that the MODE bit (DB1) in the control register should be set to 0 if OPBITEN = 1.

Comparator Output

The AD9834 has an on-board comparator. To connect this comparator to the SIGN BIT OUT pin, the SIGN/PIB (DB4) control bit must be set to 1. After filtering the sinusoidal output

from the DAC, the waveform can be applied to the comparator to generate a square waveform.

MSB from the NCO

The MSB from the NCO can be output from the AD9834. By setting the SIGN/PIB (DB4) control bit to 0, the MSB of the DAC data is available at the SIGN BIT OUT pin. This is useful as a coarse clock source. This square wave can also be divided by two before being output. Bit DIV2 (DB3) in the control register controls the frequency of this output from the SIGN BIT OUT pin.

Table 17. Various Outputs from SIGN BIT OUT

| OPBITEN Bit | MODE Bit | SIGN/PIB Bit | DIV2 Bit | SIGN BIT OUT Pin |
|-------------|----------|--------------|----------|-------------------|
| 0 | X | X | X | High impedance |
| 1 | 0 | 0 | 0 | DAC data MSB/2 |
| 1 | 0 | 0 | 1 | DAC data MSB |
| 1 | 0 | 1 | 0 | Reserved |
| 1 | 0 | 1 | 1 | Comparator output |
| 1 | 1 | X | X | Reserved |

THE IOUT AND IOUTB PINS

The analog outputs from the AD9834 are available from the IOUT and IOUTB pins. The available outputs are a sinusoidal output or a triangle output.

Sinusoidal Output

The SIN ROM converts the phase information from the frequency and phase registers into amplitude information, resulting in a sinusoidal signal at the output. To have a sinusoidal output from the IOUT and IOUTB pins, set Bit MODE (DB1) to 0.

Triangle Output

The SIN ROM can be bypassed so that the truncated digital output from the NCO is sent to the DAC. In this case, the output is no longer sinusoidal. The DAC produces 10-bit linear triangular function. To have a triangle output from the IOUT and IOUTB pins, set Bit MODE (DB1) to 1.

Note that the SLEEP pin and SLEEP12 bit must be 0 (that is, the DAC is enabled) when using the IOUT and IOUTB pins.

Table 18. Various Outputs from IOUT and IOUTB

| OPBITEN Bit | MODE Bit | IOUT and IOUTB Pins |
|-------------|----------|---------------------|
| 0 | 0 | Sinusoid |
| 0 | 1 | Triangle |
| 1 | 0 | Sinusoid |
| 1 | 1 | Reserved |

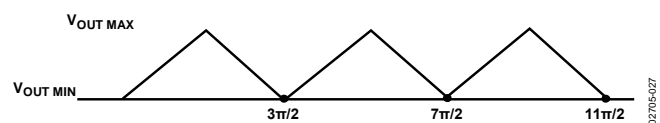

Figure 30. Triangle Output

APPLICATIONS INFORMATION

Because of the various output options available from the part, the AD9834 can be configured to suit a wide variety of applications.

One of the areas where the AD9834 is suitable is in modulation applications. The part can be used to perform simple modulation such as FSK. More complex modulation schemes such as GMSK and QPSK can also be implemented using the AD9834.

In an FSK application, the two frequency registers of the AD9834 are loaded with different values. One frequency represents the space frequency, and the other represents the mark frequency. The digital data stream is fed to the FSELECT

pin, causing the AD9834 to modulate the carrier frequency between the two values.

The AD9834 has two phase registers, enabling the part to perform PSK. With phase shift keying, the carrier frequency is phase shifted, the phase being altered by an amount that is related to the bit stream that is input to the modulator.

The AD9834 is also suitable for signal generator applications. With the on-board comparator, the device can be used to generate a square wave.

With its low current consumption, the part is suitable for applications where it is used as a local oscillator.

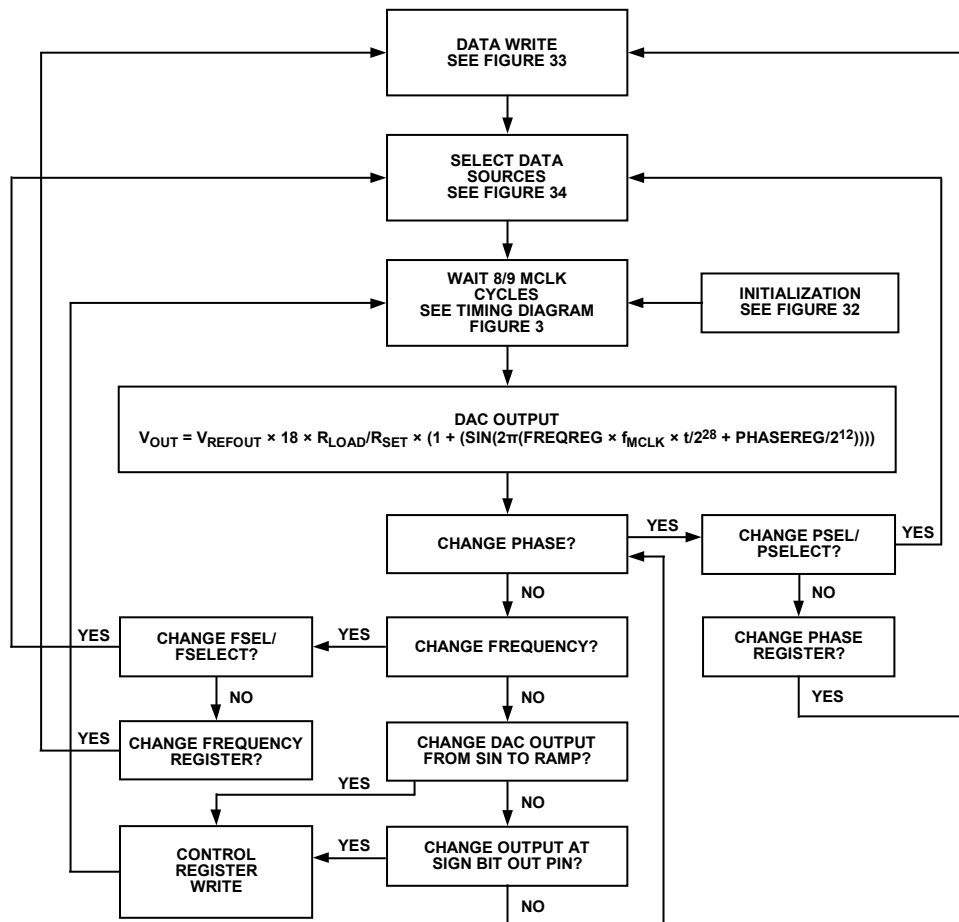

Figure 31. Flow Chart for Initialization and Operation

02705-028

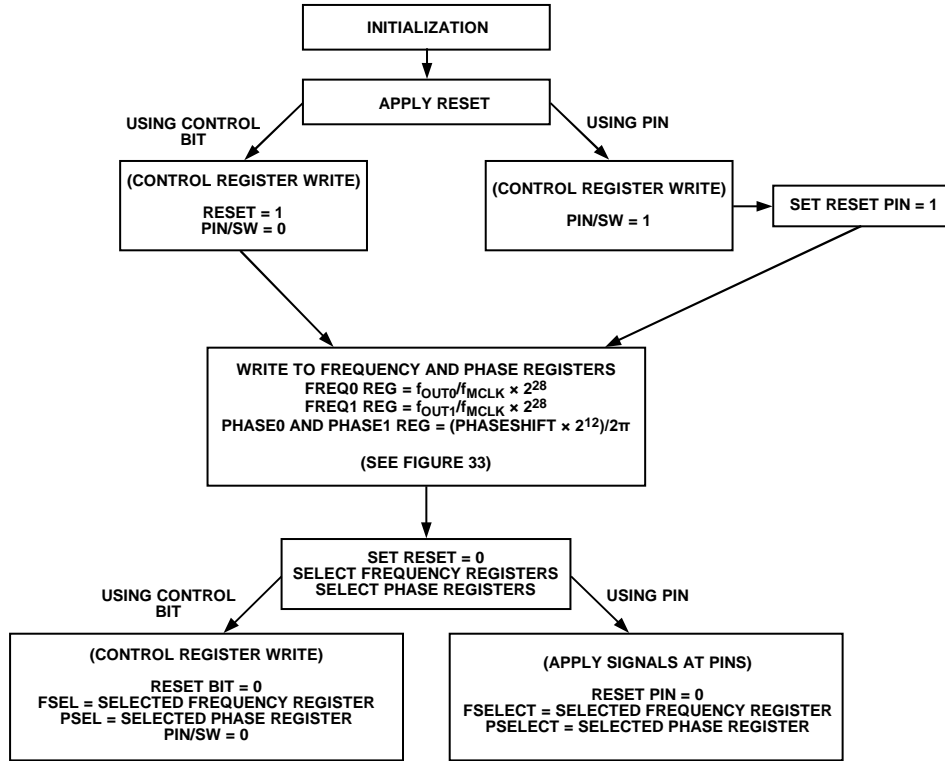

Figure 32. Initialization

02705-029

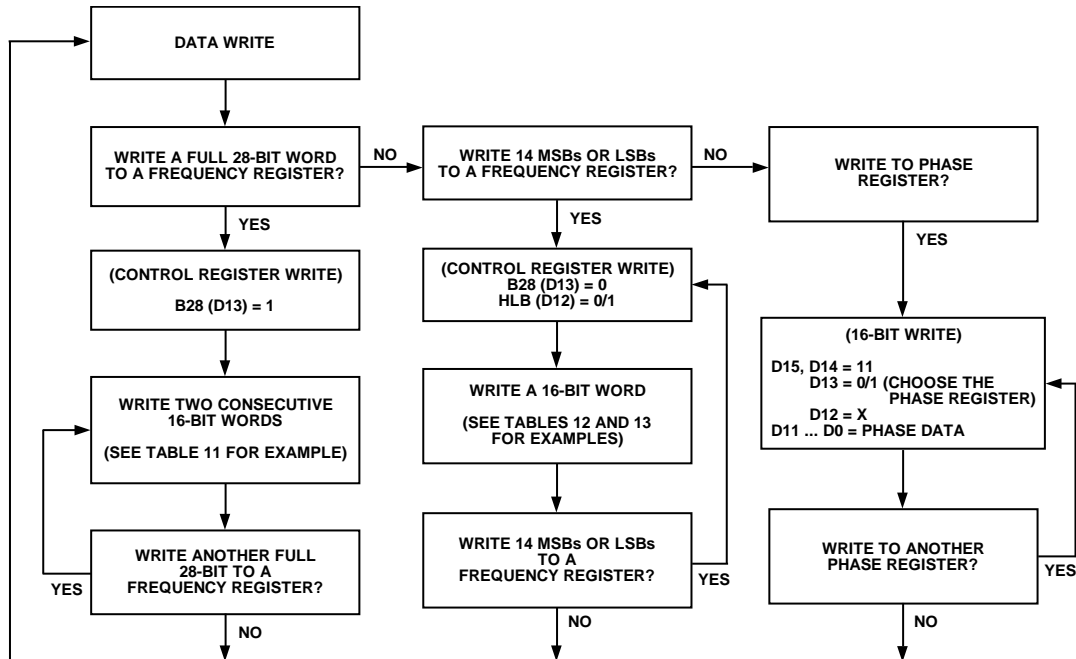
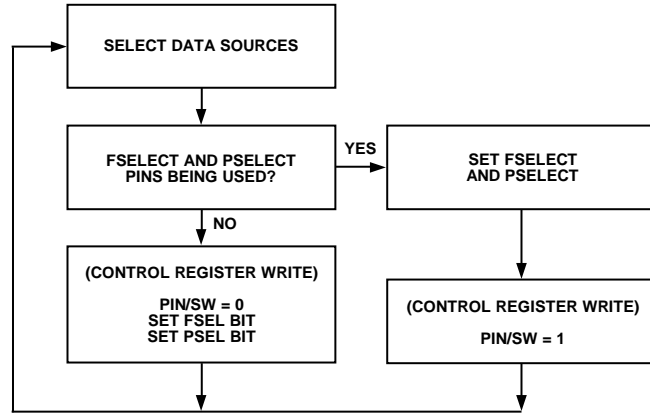

Figure 33. Data Write

02705-030



027105-031

Figure 34. Selecting Data Sources

GROUNDING AND LAYOUT

The printed circuit board (PCB) that houses the [AD9834](#) should be designed so that the analog and digital sections are separated and confined to certain areas of the board. This facilitates the use of ground planes that can easily be separated. A minimum etch technique is generally best for ground planes because it gives the best shielding. Digital and analog ground planes should only be joined in one place. If the [AD9834](#) is the only device requiring an AGND-to-DGND connection, the ground planes should be connected at the AGND and DGND pins of the [AD9834](#). If the [AD9834](#) is in a system where multiple devices require AGND-to-DGND connections, the connection should be made at one point only, establishing a star ground point as close as possible to the [AD9834](#).

Avoid running digital lines under the device because these couple noise onto the die. The analog ground plane should be allowed to run under the [AD9834](#) to avoid noise coupling. The power supply lines to the [AD9834](#) should use as large a track as possible to provide low impedance paths and reduce the effects of glitches on the power supply line. Fast switching signals, such as clocks, should be shielded with digital ground to avoid radiating noise to other sections of the board. Avoid crossover of digital and analog signals. Traces on opposite sides of the board should run at right angles to each other to reduce the effects of feed-through through the board. A microstrip technique is by far the best, but it is not always possible with a double-sided board. In this technique, the component side of the board is dedicated to ground planes and signals are placed on the other side.

Good decoupling is important. The analog and digital supplies to the [AD9834](#) are independent and separately pinned out to minimize coupling between analog and digital sections of the device. All analog and digital supplies should be decoupled to AGND and DGND, respectively, with 0.1 μF ceramic capacitors in parallel with 10 μF tantalum capacitors. To achieve the best performance from the decoupling capacitors, they should be placed as close as possible to the device, ideally right up against the device. In systems where a common supply is used to drive both the AVDD and DVDD of the [AD9834](#), it is recommended that the system's AVDD supply be used. This supply should have the recommended analog supply decoupling between the AVDD pins of the [AD9834](#) and AGND, and the recommended digital supply decoupling capacitors between the DVDD pins and DGND.

Proper operation of the comparator requires good layout strategy. The strategy must minimize the parasitic capacitance between VIN and the SIGN BIT OUT pin by adding isolation using a ground plane. For example, in a multilayered board, the VIN signal could be connected to the top layer, and the SIGN BIT OUT could be connected to the bottom layer so that isolation is provided by the power and ground planes between them.

INTERFACING TO MICROPROCESSORS

The AD9834 has a standard serial interface that allows the part to interface directly with several microprocessors. The device uses an external serial clock to write the data/control information into the device. The serial clock can have a frequency of 40 MHz maximum. The serial clock can be continuous, or it can idle high or low between write operations. When data/control information is being written to the AD9834, FSYNC is taken low and is held low until the 16 bits of data are written into the AD9834. The FSYNC signal frames the 16 bits of information being loaded into the AD9834.

AD9834 TO ADSP-21xx INTERFACE

Figure 35 shows the serial interface between the AD9834 and the ADSP-21xx. The ADSP-21xx should be set up to operate in the SPORT transmit alternate framing mode (TFSW = 1). The ADSP-21xx is programmed through the SPORT control register and should be configured as follows:

- Internal clock operation (ISCLK = 1)
- Active low framing (INVTFS = 1)
- 16-bit word length (SLEN = 15)
- Internal frame sync signal (ITFS = 1)
- Generate a frame sync for each write (TFSR = 1)

Transmission is initiated by writing a word to the Tx register after the SPORT has been enabled. The data is clocked out on each rising edge of the serial clock and clocked into the AD9834 on the SCLK falling edge.

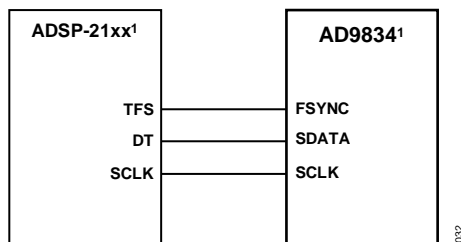

¹ADDITIONAL PINS OMITTED FOR CLARITY.

Figure 35. ADSP-21xx to AD9834 Interface

02705-032

AD9834 TO 68HC11/68L11 INTERFACE

Figure 36 shows the serial interface between the AD9834 and the 68HC11/68L11 microcontroller. The microcontroller is configured as the master by setting Bit MSTR in the SPCR to 1, providing a serial clock on SCK while the MOSI output drives the serial data line SDATA. Because the microcontroller does not have a dedicated frame sync pin, the FSYNC signal is derived from a port line (PC7). The setup conditions for correct operation of the interface are as follows:

- SCK idles high between write operations (CPOL = 0)
- Data is valid on the SCK falling edge (CPHA = 1)

When data is being transmitted to the AD9834, the FSYNC line is taken low (PC7). Serial data from the 68HC11/68L11 is transmitted in 8-bit bytes with only eight falling clock edges occurring in the transmit cycle. Data is transmitted MSB first. To load data into the AD9834, PC7 is held low after the first eight bits are transferred and a second serial write operation is performed to the AD9834. Only after the second eight bits have been transferred should FSYNC be taken high again.

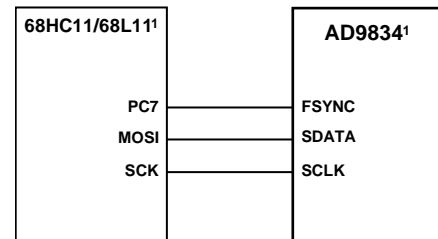

¹ADDITIONAL PINS OMITTED FOR CLARITY.

Figure 36. 68HC11/68L11 to AD9834 Interface

02705-033

AD9834 TO 80C51/80L51 INTERFACE

Figure 37 shows the serial interface between the AD9834 and the 80C51/80L51 microcontroller. The microcontroller is operated in Mode 0 so that TXD of the 80C51/80L51 drives SCLK of the AD9834, and RXD drives the serial data line (SDATA). The FSYNC signal is derived from a bit programmable pin on the port (P3.3 is shown in the diagram). When data is to be transmitted to the AD9834, P3.3 is taken low. The 80C51/80L51 transmits data in 8-bit bytes, thus only eight falling SCLK edges occur in each cycle. To load the remaining eight bits to the AD9834, P3.3 is held low after the first eight bits have been transmitted, and a second write operation is initiated to transmit the second byte of data. P3.3 is taken high following the completion of the second write operation. SCLK should idle high between the two write operations. The 80C51/80L51 outputs the serial data in an LSB-first format. The AD9834 accepts the MSB first (the four MSBs being the control information, the next four bits being the address, and the eight LSBs containing the data when writing to a destination register). Therefore, the transmit routine of the 80C51/80L51 must take this into account and rearrange the bits so that the MSB is output first.

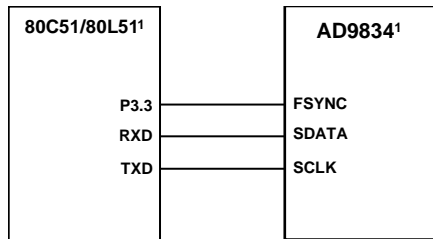

¹ADDITIONAL PINS OMITTED FOR CLARITY.

Figure 37. 80C51/80L51 to AD9834 Interface

027105-004

AD9834 TO DSP56002 INTERFACE

Figure 38 shows the interface between the AD9834 and the DSP56002. The DSP56002 is configured for normal mode asynchronous operation with a gated internal clock (SYN = 0, GCK = 1, SCKD = 1). The frame sync pin is generated internally (SC2 = 1), the transfers are 16 bits wide (WL1 = 1, WL0 = 0), and the frame sync signal frames the 16 bits (FSL = 0). The frame sync signal is available on Pin SC2, but needs to be inverted before being applied to the AD9834. The interface to the DSP56000/ DSP56001 is similar to that of the DSP56002.

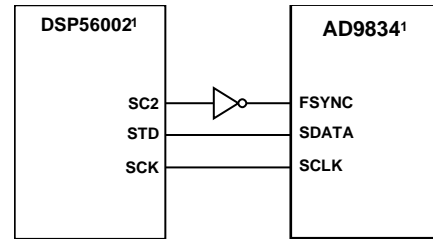

¹ADDITIONAL PINS OMITTED FOR CLARITY.

Figure 38. DSP56002 to AD9834 Interface

027105-035

OUTLINE DIMENSIONS

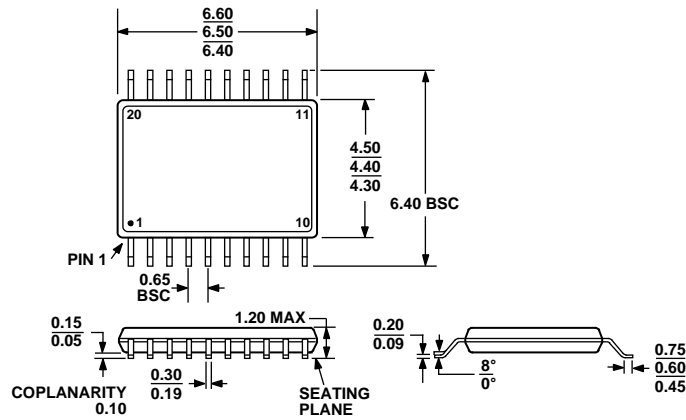

COMPLIANT TO JEDEC STANDARDS MO-153-AC

Figure 39. 20-Lead Thin Shrink Small Outline Package [TSSOP] (RU-20)
Dimensions shown in millimeters

ORDERING GUIDE

| Model ¹ | Maximum MCLK (MHz) | Temperature Range | Package Description | Package Option |
|--------------------|--------------------|-------------------|---|----------------|
| AD9834BRU | 50 | -40°C to +105°C | 20-Lead Thin Shrink Small Outline Package [TSSOP] | RU-20 |
| AD9834BRU-REEL | 50 | -40°C to +105°C | 20-Lead Thin Shrink Small Outline Package [TSSOP] | RU-20 |
| AD9834BRU-REEL7 | 50 | -40°C to +105°C | 20-Lead Thin Shrink Small Outline Package [TSSOP] | RU-20 |
| AD9834BRUZ | 50 | -40°C to +105°C | 20-Lead Thin Shrink Small Outline Package [TSSOP] | RU-20 |
| AD9834BRUZ-REEL | 50 | -40°C to +105°C | 20-Lead Thin Shrink Small Outline Package [TSSOP] | RU-20 |
| AD9834BRUZ-REEL7 | 50 | -40°C to +105°C | 20-Lead Thin Shrink Small Outline Package [TSSOP] | RU-20 |
| AD9834CRUZ | 75 | -40°C to +105°C | 20-Lead Thin Shrink Small Outline Package [TSSOP] | RU-20 |
| AD9834CRUZ-REEL7 | 75 | -40°C to +105°C | 20-Lead Thin Shrink Small Outline Package [TSSOP] | RU-20 |

¹ Z = RoHS Compliant Part.

NOTES

NOTES

NOTES

Mouser Electronics

Authorized Distributor

Click to View Pricing, Inventory, Delivery & Lifecycle Information:

[Analog Devices Inc.:](#)

[AD9834CRUZ](#) [AD9834BRU](#) [AD9834CRUZ-REEL7](#) [AD9834BRUZ-REEL](#) [AD9834BRUZ](#) [AD9834BRUZ-REEL7](#)
[AD9834BRU-REEL7](#)