

FEATURES

- **Ideal for Battery-Powered Applications**
 - **Low Voltage: 1.8V to 16V Operation**
 - **Low Current: 16 μ A/Amplifier Max**
 - **Small Packages: DFN, MSOP, SSOP**
 - **Shutdown to 1.5 μ A Max (LT6000, LT6001DD)**
- **Low Offset Voltage: 600 μ V Max**
- Rail-to-Rail Input and Output
- Fully Specified on 1.8V and 5V Supplies
- Operating Temperature Range: -40°C to 85°C
- Single Available in DFN
 - Dual Available in MSOP and DFN
 - Quad Available in SSOP and DFN

APPLICATIONS

- Gas Sensing
- Portable Instrumentation
- Battery- or Solar-Powered Systems
- Low Voltage Signal Processing
- Micropower Active Filters

DESCRIPTION

The LT[®]6000/LT6001/LT6002 are single, dual and quad precision rail-to-rail input and output operational amplifiers. Designed to maximize battery life in always-on applications, the devices will operate on supplies down to 1.8V while drawing only 13 μ A quiescent current. The low supply current and low voltage operation is combined with precision specifications; input offset is guaranteed less than 600 μ V. The performance on 1.8V supplies is fully specified and guaranteed over temperature. A shutdown feature available in the LT6000 and the 10-lead dual LT6001 version can be used to extend battery life by allowing the amplifiers to be switched off during periods of inactivity.

The LT6000 is available in a tiny, dual fine pitch leadless DFN package. The LT6001 is available in the 8-pin MSOP package; a 10-lead version with the shutdown feature is available in DFN package. The quad LT6002 is available in the 16-pin SSOP package and the 16-pin DFN package. These devices are specified over the commercial and industrial temperature range.

LT, LTC and LT are registered trademarks of Linear Technology Corporation. All other trademarks are the property of their respective owners.

TYPICAL APPLICATION

Micropower Oxygen Sensor

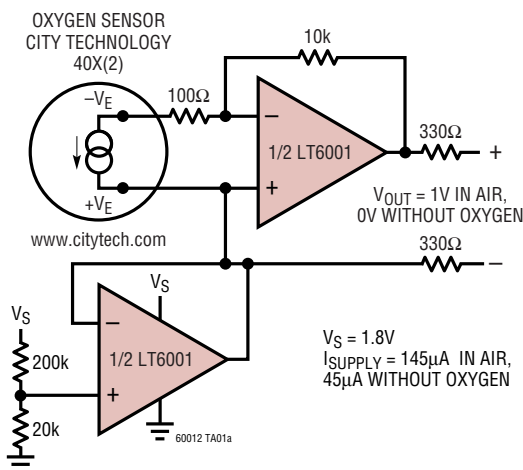

Start-Up Characteristics
Supply Current vs Supply Voltage

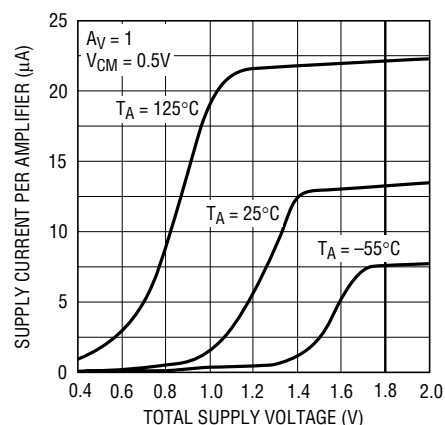

LT6000/LT6001/LT6002

ABSOLUTE MAXIMUM RATINGS (Note 1)

| | | | |
|---|-------------------|---|----------------|
| Total Supply Voltage (V^+ to V^-) | 18V | Junction Temperature (DFN Packages) | 125°C |
| Input Current | $\pm 10\text{mA}$ | Storage Temperature Range | -65°C to 150°C |
| SHDN Pin Voltage (Note 7) | V^- to V^+ | Storage Temperature Range | |
| Output Short Current Duration (Note 2) | Indefinite | DFN Packages | -65°C to 125°C |
| Operating Temperature Range (Note 3) ... | -40°C to 85°C | Lead Temperature (Soldering, 10 sec) | |
| Specified Temperature Range (Note 4) | -40°C to 85°C | MSOP, SSOP Packages | 300°C |
| Junction Temperature | 150°C | | |

PACKAGE/ORDER INFORMATION

| | | | | | |
|---|-------------------|--|-------------------|--|------------------|
|  <p>DCB PACKAGE 6-LEAD (2mm x 3mm) PLASTIC DFN $T_{JMAX} = 125^\circ\text{C}$, $\theta_{JA} = 160^\circ\text{C/W}$ (NOTE 2) EXPOSED PAD (PIN 7) IS CONNECTED TO V^- (PIN 5)</p> | |  <p>MS8 PACKAGE 8-LEAD PLASTIC MSOP $T_{JMAX} = 150^\circ\text{C}$, $\theta_{JA} = 250^\circ\text{C/W}$</p> | |  <p>DD PACKAGE 10-LEAD (3mm x 3mm) PLASTIC DFN $T_{JMAX} = 125^\circ\text{C}$, $\theta_{JA} = 160^\circ\text{C/W}$ (NOTE 2) EXPOSED PAD (PIN 11) IS CONNECTED TO V^- (PIN 4)</p> | |
| ORDER PART NUMBER | DCB PART MARKING* | ORDER PART NUMBER | MS8 PART MARKING* | ORDER PART NUMBER | DD PART MARKING* |
| LT6000CDCB LT6000IDCB | LCDM LCDM | LT6001CMS8 LT6001IMS8 | LTBVD LTBVD | LT6001CDD LT6001IDD | LBVH LBVH |
|  <p>GN PACKAGE 16-LEAD NARROW PLASTIC SSOP $T_{JMAX} = 150^\circ\text{C}$, $\theta_{JA} = 135^\circ\text{C/W}$</p> | |  <p>DHC PACKAGE 16-LEAD (5mm x 3mm) DFN $T_{JMAX} = 125^\circ\text{C}$, $\theta_{JA} = 160^\circ\text{C/W}$ (NOTE 2) EXPOSED PAD (PIN 17) IS CONNECTED TO V^- (PIN 13)</p> | | | |
| ORDER PART NUMBER | GN PART MARKING | ORDER PART NUMBER | DHC PART MARKING* | | |
| LT6002CGN LT6002IGN | 6002 6002I | LT6002CDHC LT6002IDHC | 6002 6002 | | |
| Order Options Tape and Reel: Add #TR Lead Free: Add #PBF Lead Free Tape and Reel: Add #TRPBF Lead Free Part Marking: http://www.linear.com/leadfree/ | | | | | |

*Temperature grades are identified on the shipping container. Consult LTC Marketing for parts specified with wider operating temperature ranges.

ELECTRICAL CHARACTERISTICS The ● denotes specifications which apply over the full specified temperature range, otherwise specifications are $T_A = 25^\circ\text{C}$. $V_S = 1.8\text{V}$, 0V , $V_{CM} = V_{OUT} = 0.5\text{V}$. For the LT6000 and the LT6001DD, $V_{SHDN} = V^+$, unless otherwise noted.

| SYMBOL | PARAMETER | CONDITIONS | MIN | TYP | MAX | UNITS |
|--------------------------|-------------------------------------|---|-----|------|---------------|------------------------------|
| V_{OS} | Input Offset Voltage | LT6001MS8 $0^\circ\text{C} \leq T_A \leq 70^\circ\text{C}$ $-40^\circ\text{C} \leq T_A \leq 85^\circ\text{C}$ | ● | 200 | 600 | μV |
| | | ● | | 800 | μV | |
| | | ● | | 950 | μV | |
| | | LT6000DCB, LT6001DD, LT6002GN $0^\circ\text{C} \leq T_A \leq 70^\circ\text{C}$ $-40^\circ\text{C} \leq T_A \leq 85^\circ\text{C}$ | ● | 250 | 750 | μV |
| | | ● | | 1000 | μV | |
| | | ● | | 1200 | μV | |
| V_{OS} | Input Offset Voltage | LT6002DHC $0^\circ\text{C} \leq T_A \leq 70^\circ\text{C}$ $-40^\circ\text{C} \leq T_A \leq 85^\circ\text{C}$ | ● | 300 | 900 | μV |
| | | ● | | 1100 | μV | |
| | | ● | | 1300 | μV | |
| V_{OS} | Input Offset Voltage | $V_{CM} = V^+$ LT6001MS8 | ● | 400 | 1000 | μV |
| | | ● | | 1300 | μV | |
| V_{OS} | Input Offset Voltage | $V_{CM} = V^+$ LT6000DCB, LT6001DD, LT6002GN | ● | 500 | 1200 | μV |
| | | ● | | 1550 | μV | |
| V_{OS} | Input Offset Voltage | $V_{CM} = V^+$ LT6002DHC | ● | 500 | 1300 | μV |
| | | ● | | 1700 | μV | |
| $\Delta V_{OS}/\Delta T$ | Input Offset Voltage Drift (Note 5) | $V_{CM} = 0.5\text{V}$ | ● | 2 | 5 | $\mu\text{V}/^\circ\text{C}$ |
| I_B | Input Bias Current | $V_{CM} = 0.5\text{V}$ | ● | -5 | -2 | nA |
| | | $V_{CM} = V^-$ | ● | -5 | -2 | nA |
| | | $V_{CM} = V^+$ | ● | | 4 | 10 |
| I_{OS} | Input Offset Current | $V_{CM} = 0.5\text{V}$ | ● | 0.2 | 1 | nA |
| | | $V_{CM} = V^-$ | ● | 0.2 | 1 | nA |
| | | $V_{CM} = V^+$ | ● | 0.4 | 2 | nA |
| | Input Noise Voltage | 0.1Hz to 10Hz | | 1.2 | | μV_{P-P} |
| e_n | Input Voltage Noise Density | $f = 1\text{kHz}$ | | 75 | | $\text{nV}/\sqrt{\text{Hz}}$ |
| i_n | Input Current Noise Density | $f = 1\text{kHz}$ | | 25 | | $\text{fA}/\sqrt{\text{Hz}}$ |
| R_{IN} | Input Resistance | Common Mode ($V_{CM} = 0\text{V}$ to 0.6V) | | 3.5 | | $\text{G}\Omega$ |
| | | Differential | | 10 | 25 | $\text{M}\Omega$ |
| C_{IN} | Input Capacitance | | | 5 | | pF |
| CMRR | Common Mode Rejection Ratio | $V_{CM} = 0\text{V}$ to 0.6V , $0^\circ\text{C} \leq T_A \leq 70^\circ\text{C}$ | ● | 82 | 96 | dB |
| | | $V_{CM} = 0.1\text{V}$ to 0.6V , $-40^\circ\text{C} \leq T_A \leq 85^\circ\text{C}$ | ● | 82 | 96 | dB |
| | | $V_{CM} = 0\text{V}$ to 1.8V | ● | 60 | 78 | dB |
| | Input Voltage Range | | ● | 0 | 1.8 | V |
| PSRR | Power Supply Rejection Ratio | $V_S = 1.8\text{V}$ to 16V $V_{CM} = V_O = 0.5\text{V}$ | ● | 86 | 100 | dB |
| | | Minimum Supply | ● | 1.8 | | V |
| A_{VOL} | Large-Signal Gain | $V_O = 0.25\text{V}$ to 1.25V $R_L = 100\text{k}$ to GND | ● | 25 | 65 | V/mV |
| | | $R_L = 100\text{k}$ to GND | ● | 20 | | V/mV |
| | | $R_L = 10\text{k}$ to GND | ● | 40 | 125 | V/mV |
| | | $R_L = 10\text{k}$ to GND | ● | 25 | | V/mV |
| V_{OL} | Output Swing Low (Note 6) | Input Overdrive = 30mV No Load | ● | 30 | 60 | mV |
| | | $I_{SINK} = 100\mu\text{A}$ | ● | 120 | 200 | mV |
| V_{OH} | Output Swing High (Note 6) | Input Overdrive = 30mV No Load | ● | 30 | 60 | mV |
| | | $I_{SOURCE} = 100\mu\text{A}$ | ● | 140 | 225 | mV |
| | | $R_L = 10\text{k}$ to GND | ● | 160 | 250 | mV |

ELECTRICAL CHARACTERISTICS

The ● denotes specifications which apply over the full specified temperature range, otherwise specifications are $T_A = 25^\circ\text{C}$. $V_S = 1.8\text{V}$, 0V , $V_{\text{CM}} = V_{\text{OUT}} = 0.5\text{V}$. For the LT6000 and the LT6001DD, $V_{\text{SHDN}} = V^+$, unless otherwise noted.

| SYMBOL | PARAMETER | CONDITIONS | MIN | TYP | MAX | UNITS |
|-------------------|---|--|--------|------|------|---------------|
| I_{SC} | Short-Circuit Current | Short to GND | 2 | 4 | | mA |
| | | $0^\circ\text{C} \leq T_A \leq 70^\circ\text{C}$ | ● 1 | | | mA |
| | | $-40^\circ\text{C} \leq T_A \leq 85^\circ\text{C}$ | ● 0.4 | | | mA |
| | | Short to V^+ | 0.7 | 2 | | mA |
| | | $0^\circ\text{C} \leq T_A \leq 70^\circ\text{C}$ | ● 0.4 | | | mA |
| | | $-40^\circ\text{C} \leq T_A \leq 85^\circ\text{C}$ | ● 0.15 | | | mA |
| I_S | Supply Current per Amplifier | $0^\circ\text{C} \leq T_A \leq 70^\circ\text{C}$ | ● | 13 | 16 | μA |
| | | $-40^\circ\text{C} \leq T_A \leq 85^\circ\text{C}$ | ● | | 22 | μA |
| | Total Supply Current in Shutdown (Note 7) | $V_{\text{SHDN}} = 0.3\text{V}$ | ● | 0.8 | 1.5 | μA |
| I_{SHDN} | SHDN Pin Current (Note 7) | $V_{\text{SHDN}} = 1.8\text{V}$ | ● | 0 | 30 | nA |
| | | $V_{\text{SHDN}} = 0\text{V}$ | ● | -300 | -200 | nA |
| | Shutdown Output Leakage Current (Note 7) | $V_{\text{SHDN}} = 0.3\text{V}$ ($V^- \leq V_{\text{OUT}} \leq V^+$) | ● | 20 | | nA |
| V_L | SHDN Pin Input Low Voltage (Note 7) | | ● | | 0.3 | V |
| V_H | SHDN Pin Input High Voltage (Note 7) | | ● | 1.5V | | V |
| t_{ON} | Turn On Time (Note 7) | $V_{\text{SHDN}} = 0\text{V}$ to 1.8V , $R_L = 10\text{k}$ | | 400 | | μs |
| t_{OFF} | Turn Off Time (Note 7) | $V_{\text{SHDN}} = 1.8\text{V}$ to 0V , $R_L = 10\text{k}$ | | 100 | | μs |
| GBW | Gain Bandwidth Product (Note 8) | Freq = 1kHz | ● | 32 | 50 | kHz |
| | | $0^\circ\text{C} \leq T_A \leq 70^\circ\text{C}$ | ● | 28 | | kHz |
| | | $-40^\circ\text{C} \leq T_A \leq 85^\circ\text{C}$ | ● | 24 | | kHz |
| SR | Slew Rate | $A_V = -1$, $V_{\text{OUT}} = 0.25\text{V}$ to 1.5V | ● | 9 | 15 | V/ms |
| | | Measure 0.5V to 1.25V , $0^\circ\text{C} \leq T_A \leq 70^\circ\text{C}$ | ● | 7 | | V/ms |
| | | $-40^\circ\text{C} \leq T_A \leq 85^\circ\text{C}$ | ● | 5 | | V/ms |
| FPBW | Full Power Bandwidth (Note 9) | $V_{\text{OUT}} = 1.25V_{\text{P-P}}$ | | 2.3 | 3.8 | kHz |

ELECTRICAL CHARACTERISTICS The ● denotes specifications which apply over the full specified temperature range, otherwise specifications are $T_A = 25^\circ\text{C}$. $V_S = 5\text{V}$, 0V , $V_{CM} = V_{OUT} = 1/2$ Supply. For the LT6000 and the LT6001DD, $V_{SHDN} = V^+$, unless otherwise noted.

| SYMBOL | PARAMETER | CONDITIONS | MIN | TYP | MAX | UNITS |
|--------------------------|-------------------------------------|---|-------------|-------------------|-------------------|------------------------------|
| V_{OS} | Input Offset Voltage | LT6001MS8 $0^\circ\text{C} \leq T_A \leq 70^\circ\text{C}$ $-40^\circ\text{C} \leq T_A \leq 85^\circ\text{C}$ | ● | 200 | 600 | μV |
| | | | ● | | 800 | μV |
| | | | ● | | 950 | μV |
| | | LT6000DCB, LT6001DD, LT6002GN $0^\circ\text{C} \leq T_A \leq 70^\circ\text{C}$ $-40^\circ\text{C} \leq T_A \leq 85^\circ\text{C}$ | ● | 250 | 750 | μV |
| | | | ● | | 1000 | μV |
| | | | ● | | 1200 | μV |
| $\Delta V_{OS}/\Delta T$ | Input Offset Voltage Drift (Note 5) | LT6002DHC $0^\circ\text{C} \leq T_A \leq 70^\circ\text{C}$ $-40^\circ\text{C} \leq T_A \leq 85^\circ\text{C}$ | ● | 300 | 900 | μV |
| | | | ● | | 1100 | μV |
| | | | ● | | 1300 | μV |
| I_B | Input Bias Current | $V_{CM} = V^+$ LT6001MS8 | ● | 400 | 1000 | μV |
| | | | | | 1300 | μV |
| | | $V_{CM} = V^+$ LT6000DCB, LT6001DD, LT6002GN | ● | 500 | 1200 | μV |
| | | | | 1550 | μV | |
| | | $V_{CM} = V^+$ LT6002DHC | ● | 500 | 1300 | μV |
| | | | | | 1700 | μV |
| I_{OS} | Input Offset Current | $V_{CM} = V_S/2$ $V_{CM} = V^-$ $V_{CM} = V^+$ | ● ● ● | 0.2 0.2 0.4 | 1.2 1.2 2.4 | nA nA nA |
| | Input Noise Voltage | 0.1Hz to 10Hz | | 1.2 | | μV_{P-P} |
| e_n | Input Voltage Noise Density | $f = 1\text{kHz}$ | | 75 | | $\text{nV}/\sqrt{\text{Hz}}$ |
| i_n | Input Current Noise Density | $f = 1\text{kHz}$ | | 25 | | $\text{fA}/\sqrt{\text{Hz}}$ |
| R_{IN} | Input Resistance | Common Mode ($V_{CM} = 0\text{V}$ to 3.8V) Differential | ● | 8.5 | 3.5 25 | G Ω M Ω |
| C_{IN} | Input Capacitance | | | 5 | | pF |
| CMRR | Common Mode Rejection Ratio | $V_{CM} = 0\text{V}$ to 3.8V , $0^\circ\text{C} \leq T_A \leq 70^\circ\text{C}$ | ● | 90 | 105 | dB |
| | | $V_{CM} = 0.1\text{V}$ to 3.8V , $-40^\circ\text{C} \leq T_A \leq 85^\circ\text{C}$ | ● | 90 | 105 | dB |
| | | $V_{CM} = 0\text{V}$ to 5V | ● | 68 | 86 | dB |
| | Input Voltage Range | | ● | 0 | 5 | V |
| PSRR | Power Supply Rejection Ratio | $V_S = 1.8\text{V}$ to 16V $V_{CM} = V_O = 0.5\text{V}$ | ● | 86 | 100 | dB |
| | | Minimum Supply | ● | 1.8 | | V |
| A_{VOL} | Large-Signal Gain | $V_O = 0.5\text{V}$ to 4.5V $R_L = 100\text{k}$ to $V_S/2$ | ● | 30 | 60 | V/mV |
| | | $R_L = 100\text{k}$ to $V_S/2$ | ● | 25 | | V/mV |
| | | $R_L = 10\text{k}$ to $V_S/2$ | ● | 16 | 25 | V/mV |
| | | $R_L = 10\text{k}$ to $V_S/2$ | ● | 10 | | V/mV |
| | | $R_L = 10\text{k}$ to GND | ● | 160 | 1000 | V/mV |
| | | $R_L = 10\text{k}$ to GND | ● | 80 | | V/mV |
| V_{OL} | Output Swing Low (Note 6) | Input Overdrive = 30mV No Load | ● | 30 | 60 | mV |
| | | $I_{SINK} = 100\mu\text{A}$ | ● | 120 | 200 | mV |
| | | $I_{SINK} = 500\mu\text{A}$ | ● | 180 | 300 | mV |
| | | | | | | |

LT6000/LT6001/LT6002

ELECTRICAL CHARACTERISTICS The ● denotes specifications which apply over the full specified temperature range, otherwise specifications are $T_A = 25^\circ\text{C}$. $V_S = 5\text{V}$, 0V , $V_{\text{CM}} = V_{\text{OUT}} = 1/2$ Supply. For the LT6000 and the LT6001DD, $V_{\text{SHDN}} = V^+$, unless otherwise noted.

| SYMBOL | PARAMETER | CONDITIONS | MIN | TYP | MAX | UNITS |
|-------------------|---|--|-----|-------|------|---------------|
| V_{OH} | Output Swing High (Note 6) | Input Overdrive = 30mV | | | | |
| | | No Load | ● | 30 | 60 | mV |
| | | $I_{\text{SOURCE}} = 100\mu\text{A}$ $R_L = 10\text{k to GND}$ | ● | 140 | 225 | mV |
| I_{SC} | Short-Circuit Current | Short to GND | ● | 5 | 10 | mA |
| | | $0^\circ\text{C} \leq T_A \leq 70^\circ\text{C}$ | ● | 4 | | mA |
| | | $-40^\circ\text{C} \leq T_A \leq 85^\circ\text{C}$ | ● | 3 | | mA |
| I_S | Supply Current per Amplifier | Short to V^+ | ● | 3.5 | 7.5 | mA |
| | | $0^\circ\text{C} \leq T_A \leq 70^\circ\text{C}$ | ● | 2.5 | | mA |
| | | $-40^\circ\text{C} \leq T_A \leq 85^\circ\text{C}$ | ● | 1.5 | | mA |
| I_S | Supply Current per Amplifier | $0^\circ\text{C} \leq T_A \leq 70^\circ\text{C}$ | ● | 15 | 18 | μA |
| | | $-40^\circ\text{C} \leq T_A \leq 85^\circ\text{C}$ | ● | | 24 | μA |
| | | $V_S = \pm 8\text{V}$ | ● | 20 | 25 | μA |
| | | | ● | | 34 | μA |
| | Total Supply Current in Shutdown (Note 7) | $V_{\text{SHDN}} = 0.3\text{V}$ | ● | 3 | 5 | μA |
| I_{SHDN} | SHDN Pin Current (Note 7) | $V_{\text{SHDN}} = 5\text{V}$ | ● | 0 | 30 | nA |
| | | $V_{\text{SHDN}} = 0\text{V}$ | ● | -1000 | -650 | nA |
| | Shutdown Output Leakage Current (Note 7) | $V_{\text{SHDN}} = 0.3\text{V}$ ($V^- \leq V_{\text{OUT}} \leq V^+$) | ● | 20 | | nA |
| V_L | SHDN Pin Input Low Voltage (Note 7) | | ● | | 0.3 | V |
| V_H | SHDN Pin Input High Voltage (Note 7) | | ● | 4.7 | | V |
| t_{ON} | Turn On Time (Note 7) | $V_{\text{SHDN}} = 0\text{V to } 5\text{V}$, $R_L = 10\text{k}$ | | 400 | | μs |
| t_{OFF} | Turn Off Time (Note 7) | $V_{\text{SHDN}} = 5\text{V to } 0\text{V}$, $R_L = 10\text{k}$ | | 100 | | μs |
| GBW | Gain Bandwidth Product | Freq = 1kHz | | 40 | 60 | kHz |
| | | $0^\circ\text{C} \leq T_A \leq 70^\circ\text{C}$ | ● | 35 | | kHz |
| | | $-40^\circ\text{C} \leq T_A \leq 85^\circ\text{C}$ | ● | 30 | | kHz |
| SR | Slew Rate | $A_V = -1$, $V_{\text{OUT}} = 0.5\text{V to } 4.5\text{V}$ | | 11 | 18 | V/ms |
| | | Measure 1V to 4V, $0^\circ\text{C} \leq T_A \leq 70^\circ\text{C}$ | ● | 8 | | V/ms |
| | | $-40^\circ\text{C} \leq T_A \leq 85^\circ\text{C}$ | ● | 6 | | V/ms |
| FPBW | Full Power Bandwidth (Note 9) | $V_{\text{OUT}} = 4V_{\text{P-P}}$ | | 0.87 | 1.4 | kHz |

Note 1: Stresses beyond those listed under Absolute Maximum Ratings may cause permanent damage to the device. Exposure to any Absolute Maximum Rating condition for extended periods may affect device reliability and lifetime.

Note 2: A heat sink may be required to keep the junction temperature below the absolute maximum. This depends on the power supply voltage and how many amplifiers are shorted. The θ_{JA} specified for the DD and DHC packages is with minimal PCB heat spreading metal. Using expanded metal area on all layers of a board reduces this value.

Note 3: The LT6000C/LT6000I/LT6001C/LT6001I and LT6002C/LT6002I are guaranteed functional over the temperature range of -40°C to 85°C .

Note 4: The LT6000C/LT6001C/LT6002C is guaranteed to meet specified performance from 0°C to 70°C . The LT6000C/LT6001C/LT6002C are designed, characterized and expected to meet specified performance from

-40°C to 85°C but are not tested or QA sampled at these temperatures. The LT6000I/LT6001I/ LT6002I is guaranteed to meet specified performance from -40°C to 85°C .

Note 5: This parameter is not 100% tested.

Note 6: Output voltage swings are measured between the output and power supply rails.

Note 7: Specifications apply to the LT6000 or the LT6001DD with shutdown.

Note 8: Guaranteed by correlation to slew rate at $V_S = 1.8\text{V}$ and GBW at $V_S = 5\text{V}$.

Note 9: Full-power bandwidth is calculated from the slew rate:

$$\text{FPBW} = \text{SR}/\pi V_{\text{P-P}}$$

TYPICAL PERFORMANCE CHARACTERISTICS

V_{OS} Distribution



60012 G01

TC V_{OS} Distribution



20012 G02

Supply Current vs Supply Voltage



600012 G03

Change in Input Offset Voltage vs Total Supply Voltage

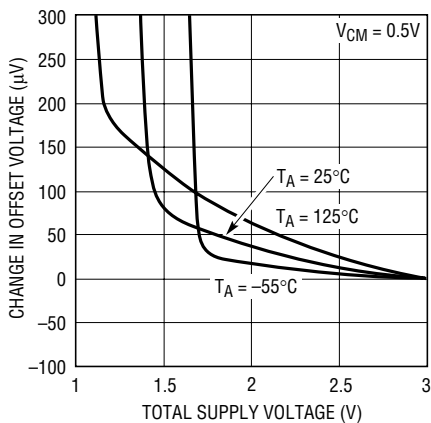

60012 G35

Input Offset Voltage vs Total Supply Voltage

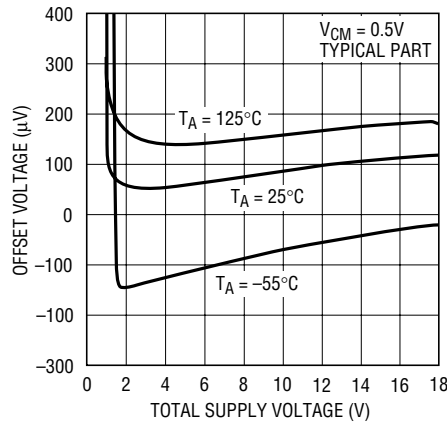

600012 G05

Input Offset Voltage vs Input Common Mode Voltage

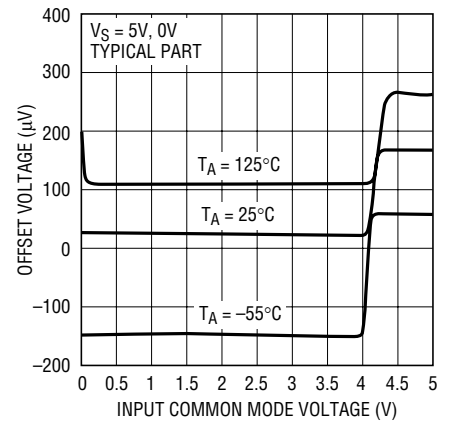

60012 G06

Input Bias Current vs Common Mode Voltage

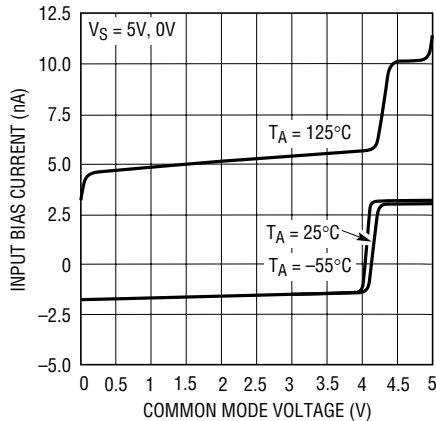

60012 G07

Output Saturation Voltage vs Load Current (Output High)

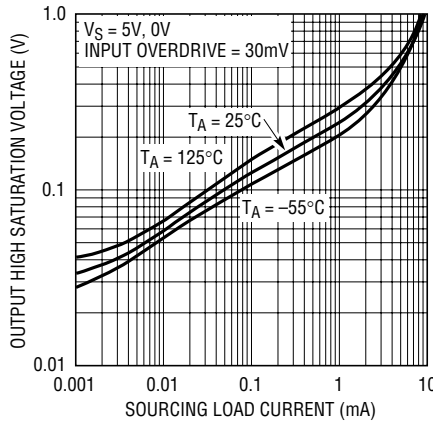

60012 G08

Output Saturation Voltage vs Load Current (Output Low)

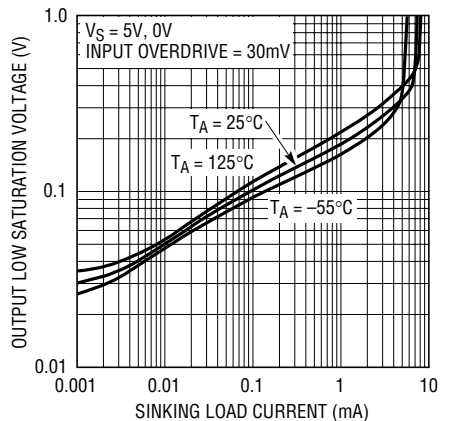

60012 G08

TYPICAL PERFORMANCE CHARACTERISTICS

Output Saturation Voltage vs Input Overdrive

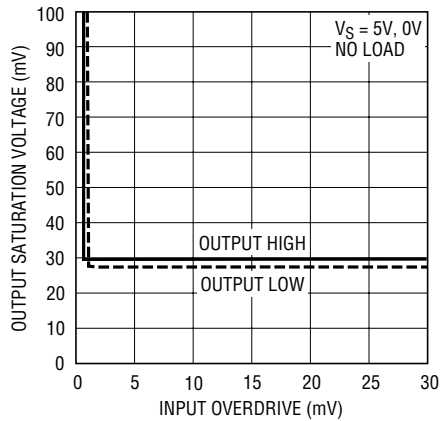

60012 G10

Output Short-Circuit Current vs Total Supply Voltage (Sourcing)

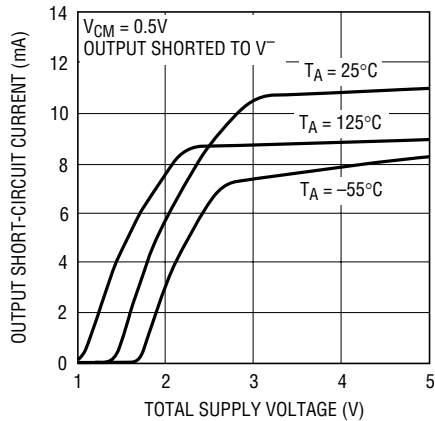

60012 G11

Output Short-Circuit Current vs Total Supply Voltage (Sinking)

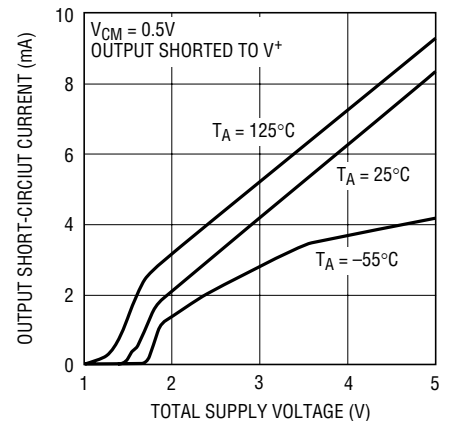

60012 G12

0.1Hz to 10Hz Output Voltage Noise

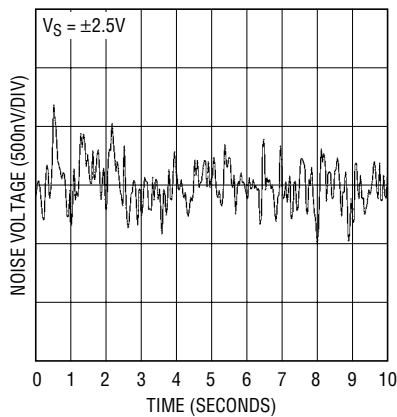

60012 G13

Noise Voltage Density vs Frequency

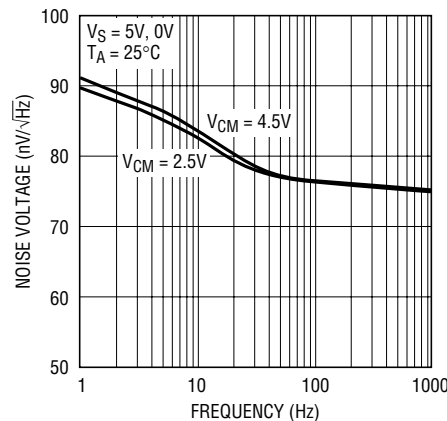

60012 G14

Input Noise Current vs Frequency

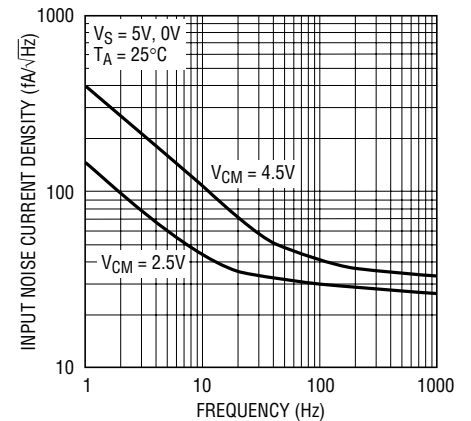

60012 G15

Open-Loop Gain

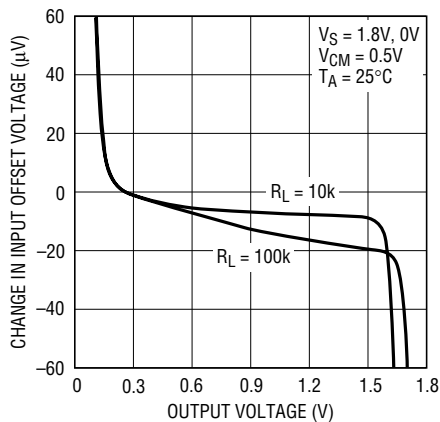

60012 G16

Open-Loop Gain

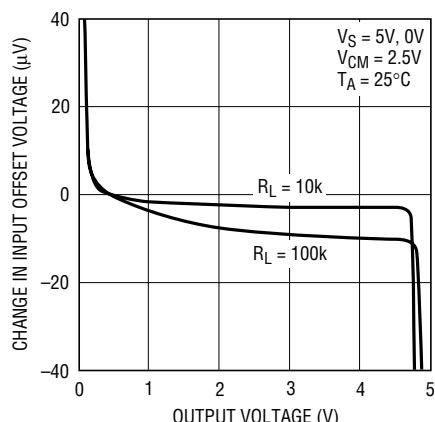

60012 G17

Open-Loop Gain

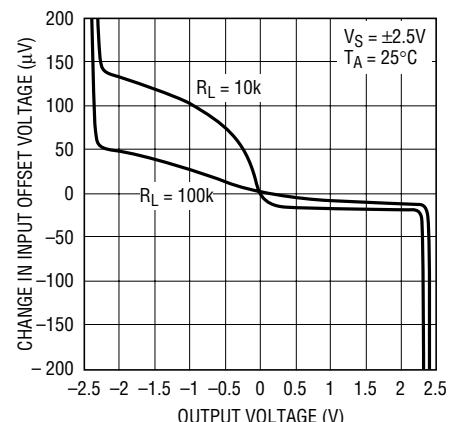

20012 G18

TYPICAL PERFORMANCE CHARACTERISTICS

Gain Bandwidth and Phase Margin vs Temperature

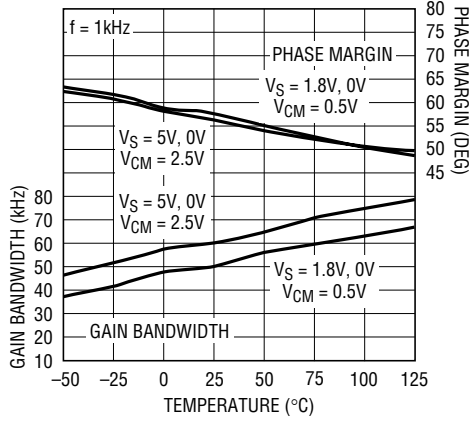

60012 G21

Slew Rate vs Temperature

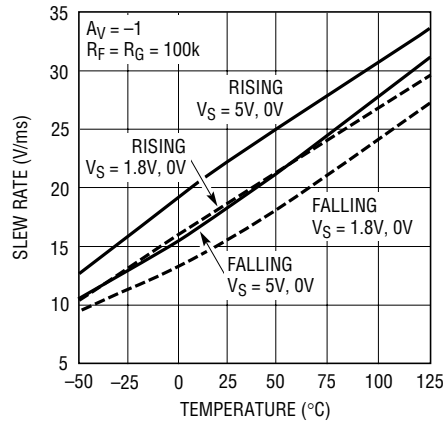

60012 G22

Gain and Phase vs Frequency

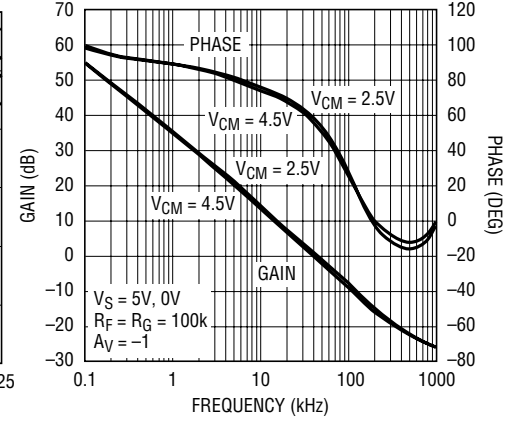

60012 G19

Gain Bandwidth and Phase Margin vs Supply Voltage

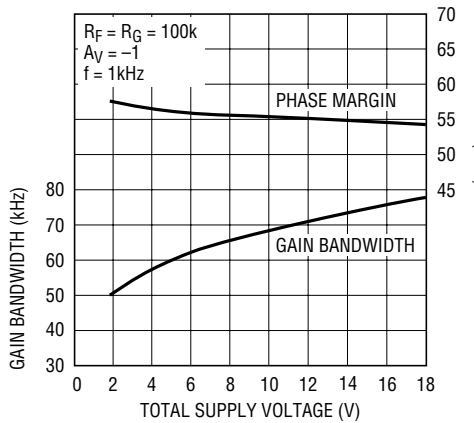

600012 G36

Capacitive Load Handling Overshoot vs Capacitive Load

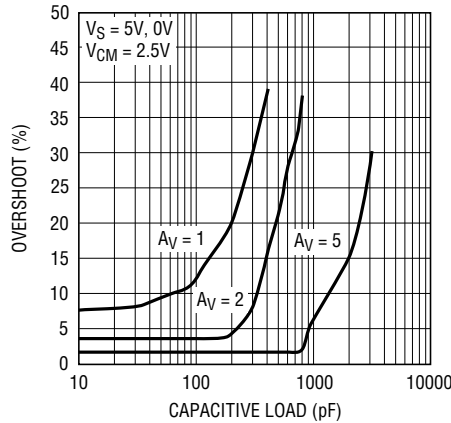

60012 G23

Common Mode Rejection Ratio vs Frequency

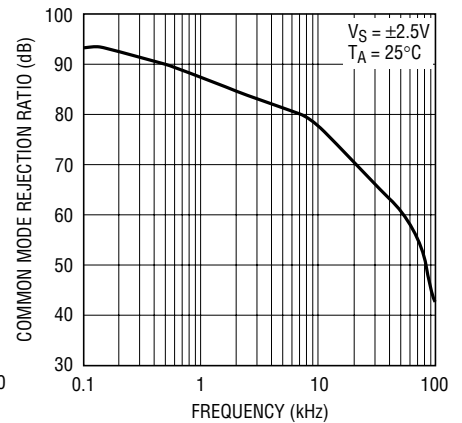

60012 G24

Power Supply Rejection Ratio vs Frequency

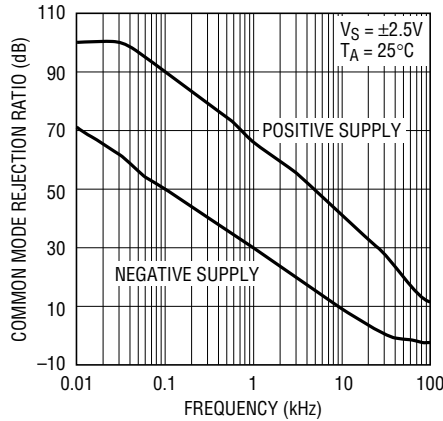

60012 G25

Output Impedance vs Frequency

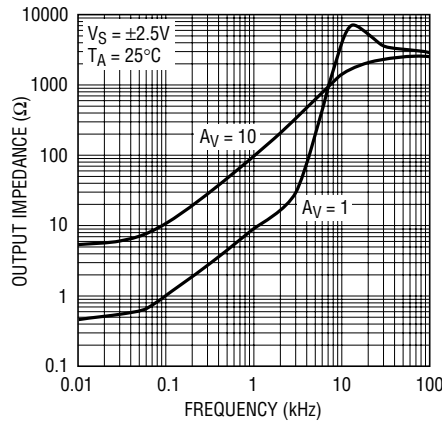

60012 G26

Disabled Output Impedance vs Frequency (LT6000/LT6001DD)

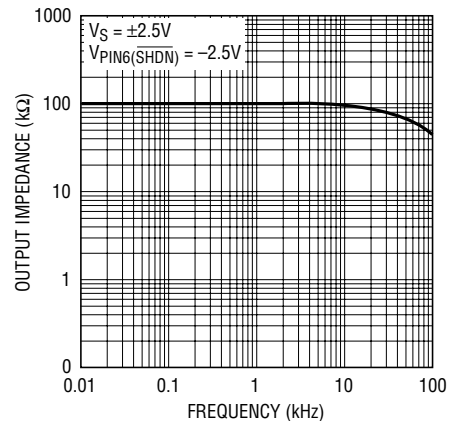

60012 G27

TYPICAL PERFORMANCE CHARACTERISTICS

Large-Signal Response

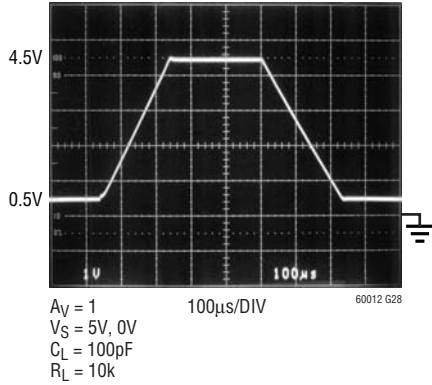

Large-Signal Response

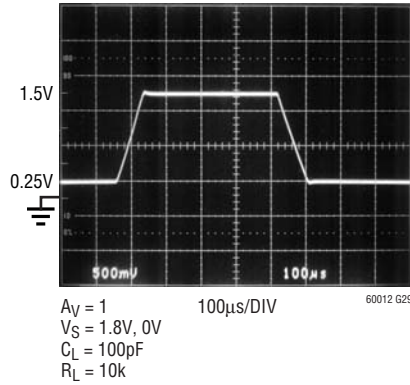

Small-Signal Response

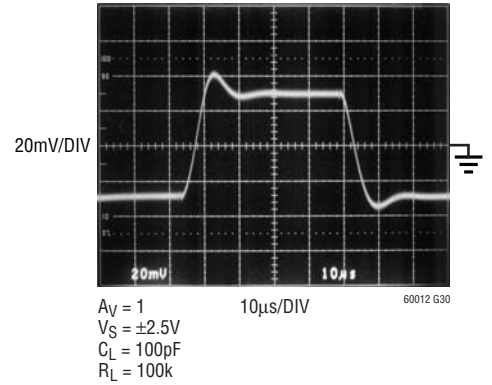

Total Supply Current vs SHDN Pin Voltage (LT6001DD)

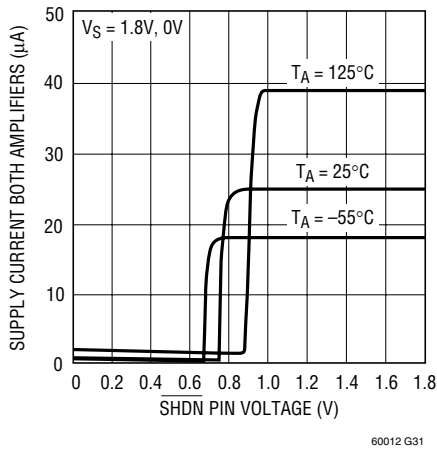

Total Supply Current vs SHDN Pin Voltage (LT6001DD)

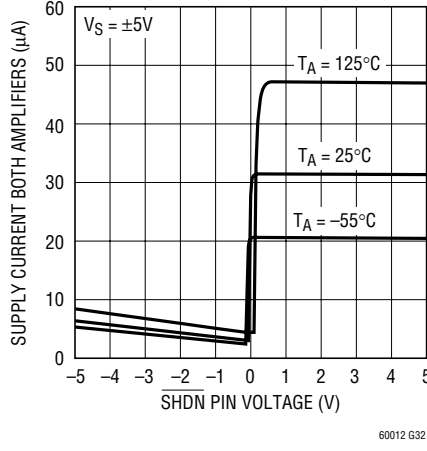

Shutdown Response (LT6000/LT6001DD)

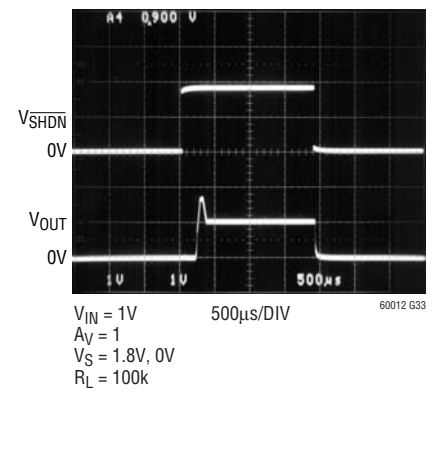

Supply Current vs SHDN Pin Voltage (LT6000)

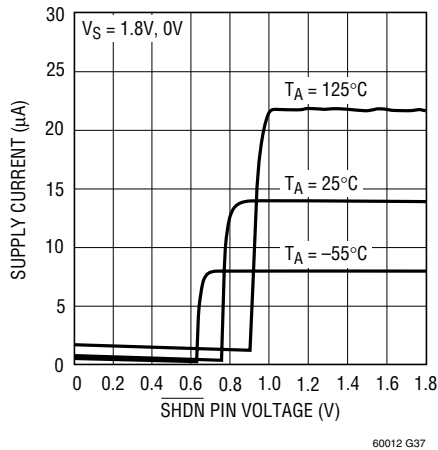

Supply Current vs SHDN Pin Voltage (LT6000)

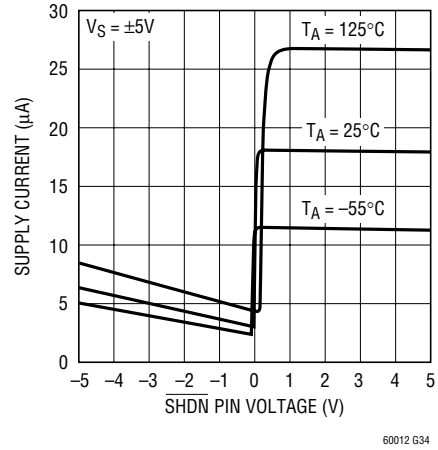

SIMPLIFIED SCHEMATIC

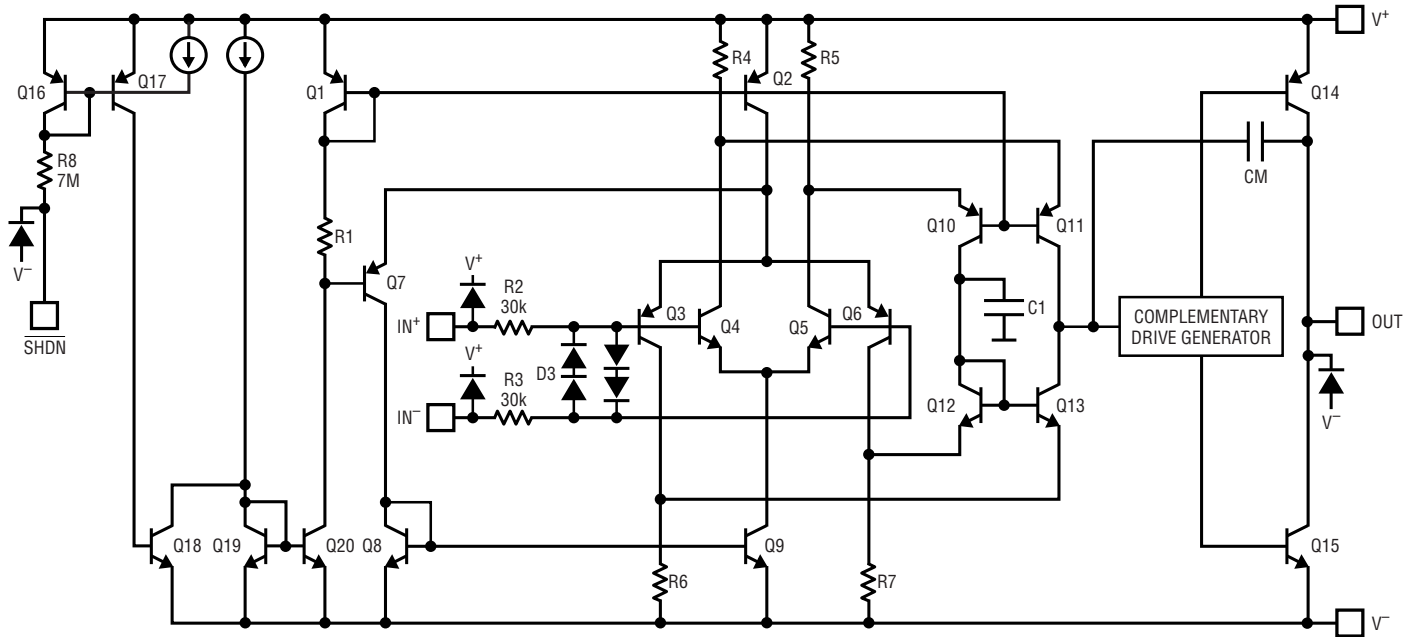

Figure 1

APPLICATIONS INFORMATION

Supply Voltage

The positive supply of the LT6000/LT6001/LT6002 should be bypassed with a small capacitor (about 0.01 μ F) within an inch of the pin. When driving heavy loads, an additional 4.7 μ F electrolytic capacitor should be used. When using split supplies, the same is true for the negative supply pin.

Rail-to-Rail Characteristics

The LT6000/LT6001/LT6002 are fully functional for an input signal range from the negative supply to the positive supply. Figure 1 shows a simplified schematic of the amplifier. The input stage consists of two differential amplifiers, a PNP stage Q3/Q6 and an NPN stage Q4/Q5 that are active over different ranges of the input common mode voltage. The PNP stage is active for common mode voltages, V_{CM} , between the negative supply to approximately 1V below the positive supply. As V_{CM} moves closer towards the positive supply, the transistor Q7 will steer Q2's tail current to the current mirror Q8/Q9, activating the NPN differential pair. The PNP pair becomes inactive for

the rest of the input common mode range up to the positive supply.

The second stage is a folded cascode and current mirror that converts the input stage differential signals into a single ended output. Capacitor C1 reduces the unity cross frequency and improves the frequency stability without degrading the gain bandwidth of the amplifier. The complementary drive generator supplies current to the output transistors that swing from rail to rail.

Input

The input bias current depends on which stage is active. The input bias current polarity depends on the input common mode voltage. When the PNP stage is active, the input bias currents flow out of the input pins. They flow in the opposite direction when the NPN stage is active. The offset error due to the input bias currents can be minimized by equalizing the noninverting and inverting source impedance.

APPLICATIONS INFORMATION

The input offset voltage changes depending on which input stage is active; input offset voltage is trimmed on both input stages, and is guaranteed to be $600\mu\text{V}$ max in the PNP stage. By trimming the input offset voltage of both input stages, the input offset voltage over the entire common mode range (CMRR) is typically $400\mu\text{V}$, maintaining the precision characteristics of the amplifier.

The input stage of the LT6000/LT6001/LT6002 incorporates phase reversal protection to prevent wrong polarity outputs from occurring when the inputs are driven up to 2V below the negative rail. 30k protective resistors are included in the input leads so that current does not become excessive when the inputs are forced below V^- or when a large differential signal is applied. Input current should be limited to 10mA when the inputs are driven above the positive rail.

Output

The output of the LT6000/LT6001/LT6002 can swing to within 30mV of the positive rail with no load and within 30mV of the negative rail with no load. When monitoring input voltages within 30mV of the positive rail or within 30mV of the negative rail, gain should be taken to keep the output from clipping. The LT6000/LT6001/LT6002 can typically source 10mA on a single 5V supply, sourcing current is reduced to 4mA on a single 1.8V supply as noted in the electrical characteristics.

The normally reverse-biased substrate diode from the output to V^- will cause unlimited currents to flow when the output is forced below V^- . If the current is transient and limited to 100mA, no damage will occur.



Figure 2. Circuits for Start-Up Characteristics

Start-Up and Output Saturation Characteristics

Micropower op amps are often not micropower during start-up characteristics or during output saturation. This can wreak havoc on limited current supplies, in the worst case there may not be enough supply current available to take the system up to nominal voltages. Also, when the output saturates, the part may draw excessive current and pull down the supplies, compromising rail-to-rail performance. Figure 1 shows the start-up characteristics of the LT6000/LT6001/LT6002 for three limiting cases. The circuits are shown in Figure 2. One circuit creates a positive offset forcing the output to come up saturated high. Another circuit creates a negative offset forcing the output to come up saturated low, while the last circuit brings the output up at 1/2 supply. In all cases, the supply current is well controlled and is not excessive when the output is on either rail.



Figure 1. Start-Up Characteristics

APPLICATIONS INFORMATION

The LT6000/LT6001/LT6002 outputs can swing to within a respectable 30mV of each rail and draw virtually no excessive supply current. Figure 3 compares the dual LT6001 to a competitive part. Both op amps are in unity gain and their outputs are driven into each rail. The supply current is shown when the op amps are in linear operation and when they are driven into each rail. As can be seen from Figure 3, the supply current of the competitive part increases 3-fold or 5-fold depending on which rail the output goes to whereas the LT6001 draws virtually no excessive current.



Figure 3. V_{OUT} and I_{CC} vs Input Voltage

Gain

The open-loop gain is almost independent of load when the output is sourcing current. This optimizes performance in single supply applications where the load is returned to ground. The typical performance curve of Open-Loop Gain for various loads shows the details.

Shutdown

The single LT6000 and the 10-lead dual LT6001 include a shutdown feature that disables the part reducing quiescent current and makes the output high impedance. The devices can be shut down by bringing the \overline{SHDN} pin within 0.3V of V^- . The amplifiers are guaranteed to shut down if the \overline{SHDN} pin is brought within 0.3V of V^- . The exact switchover point will be a function of the supply voltage. See the Typical Performance Characteristics curves Supply Current vs Shutdown Pin Voltage. When shut down the total supply current is about 0.8 μ A and the output leakage current is 20nA ($V^- \leq V_{OUT} \leq V^+$). For normal operation the \overline{SHDN} pin should be tied to V^+ . It can be left floating, however, parasitic leakage currents over 1 μ A at the \overline{SHDN} pin may inadvertently place the part into shutdown.

TYPICAL APPLICATION

**Gain of 100 Amplifier
(400kHz GBW on 30 μ A Supply)**

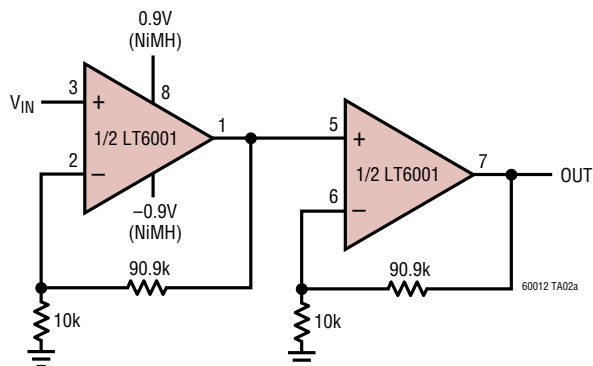

Gain vs Frequency



PACKAGE DESCRIPTION

DCB Package
6-Lead Plastic DFN (2mm × 3mm)
 (Reference LTC DWG # 05-08-1715)



RECOMMENDED SOLDER PAD PITCH AND DIMENSIONS



- NOTE:
1. DRAWING TO BE MADE A JEDEC PACKAGE OUTLINE M0-229 VARIATION OF (TBD)
 2. DRAWING NOT TO SCALE
 3. ALL DIMENSIONS ARE IN MILLIMETERS
 4. DIMENSIONS OF EXPOSED PAD ON BOTTOM OF PACKAGE DO NOT INCLUDE MOLD FLASH. MOLD FLASH, IF PRESENT, SHALL NOT EXCEED 0.15mm ON ANY SIDE
 5. EXPOSED PAD SHALL BE SOLDER PLATED
 6. SHADED AREA IS ONLY A REFERENCE FOR PIN 1 LOCATION ON THE TOP AND BOTTOM OF PACKAGE

PACKAGE DESCRIPTION

MS8 Package
8-Lead Plastic MSOP
 (Reference LTC DWG # 05-08-1660)

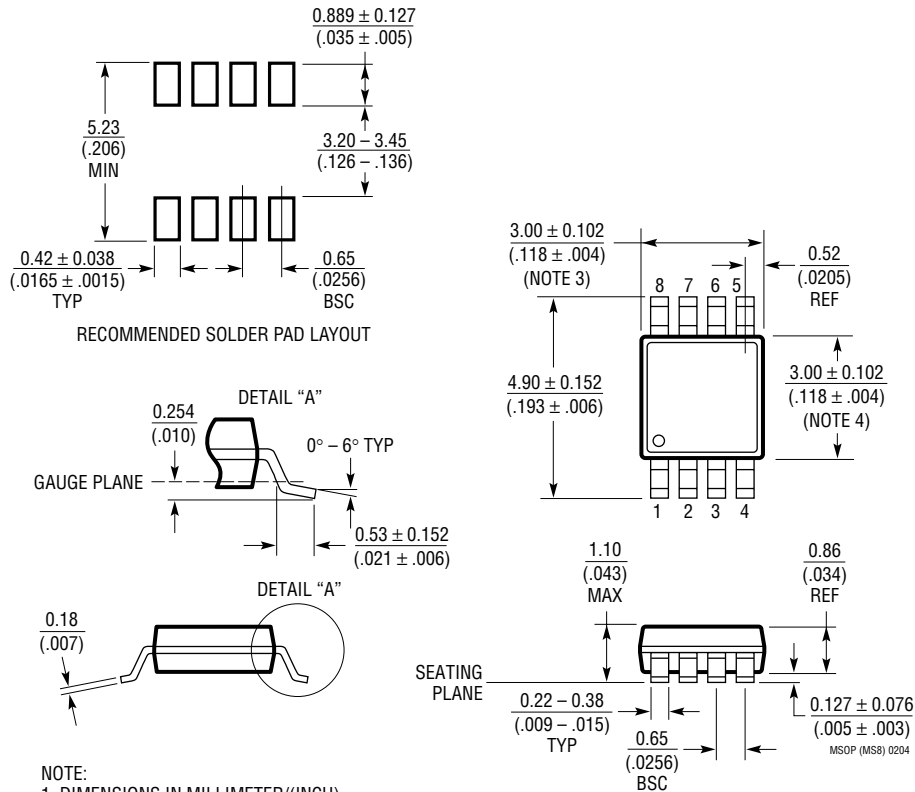

- NOTE:
1. DIMENSIONS IN MILLIMETER/(INCH)
 2. DRAWING NOT TO SCALE
 3. DIMENSION DOES NOT INCLUDE MOLD FLASH, PROTRUSIONS OR GATE BURRS. MOLD FLASH, PROTRUSIONS OR GATE BURRS SHALL NOT EXCEED 0.152mm (.006") PER SIDE
 4. DIMENSION DOES NOT INCLUDE INTERLEAD FLASH OR PROTRUSIONS. INTERLEAD FLASH OR PROTRUSIONS SHALL NOT EXCEED 0.152mm (.006") PER SIDE
 5. LEAD COPLANARITY (BOTTOM OF LEADS AFTER FORMING) SHALL BE 0.102mm (.004") MAX

PACKAGE DESCRIPTION

DD Package
10-Lead (3mm × 3mm) Plastic DFN
 (Reference LTC DWG # 05-08-1699)

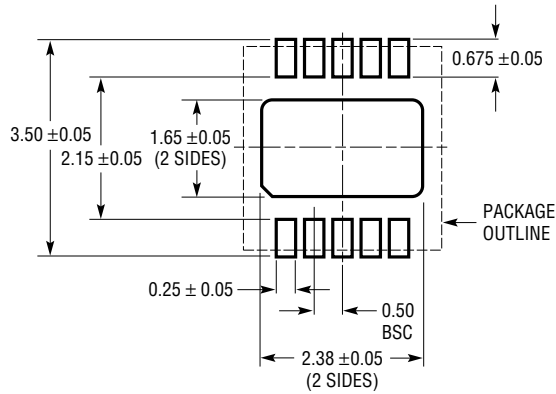

RECOMMENDED SOLDER PAD PITCH AND DIMENSIONS

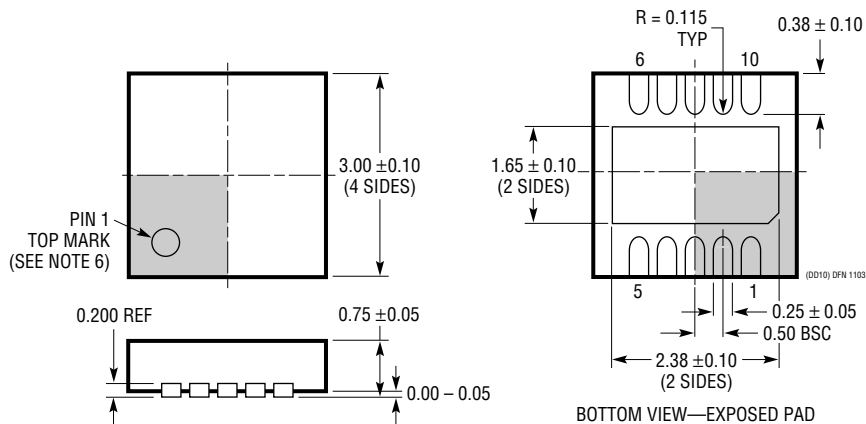

- NOTE:
1. DRAWING TO BE MADE A JEDEC PACKAGE OUTLINE M0-229 VARIATION OF (WEED-2). CHECK THE LTC WEBSITE DATA SHEET FOR CURRENT STATUS OF VARIATION ASSIGNMENT
 2. DRAWING NOT TO SCALE
 3. ALL DIMENSIONS ARE IN MILLIMETERS
 4. DIMENSIONS OF EXPOSED PAD ON BOTTOM OF PACKAGE DO NOT INCLUDE MOLD FLASH. MOLD FLASH, IF PRESENT, SHALL NOT EXCEED 0.15mm ON ANY SIDE
 5. EXPOSED PAD SHALL BE SOLDER PLATED
 6. SHADED AREA IS ONLY A REFERENCE FOR PIN 1 LOCATION ON THE TOP AND BOTTOM OF PACKAGE

PACKAGE DESCRIPTION

GN Package
16-Lead Narrow Plastic SSOP
 (Reference LTC DWG # 05-08-1641)



- NOTE:
1. CONTROLLING DIMENSION: INCHES
 2. DIMENSIONS ARE IN $\frac{\text{INCHES}}{\text{MILLIMETERS}}$
 3. DRAWING NOT TO SCALE
- *DIMENSION DOES NOT INCLUDE MOLD FLASH. MOLD FLASH SHALL NOT EXCEED 0.006" (0.152mm) PER SIDE
- **DIMENSION DOES NOT INCLUDE INTERLEAD FLASH. INTERLEAD FLASH SHALL NOT EXCEED 0.010" (0.254mm) PER SIDE

PACKAGE DESCRIPTION

DHC Package
16-Lead (5mm × 5mm) Plastic DFN
 (Reference LTC DWG # 05-08-1706)

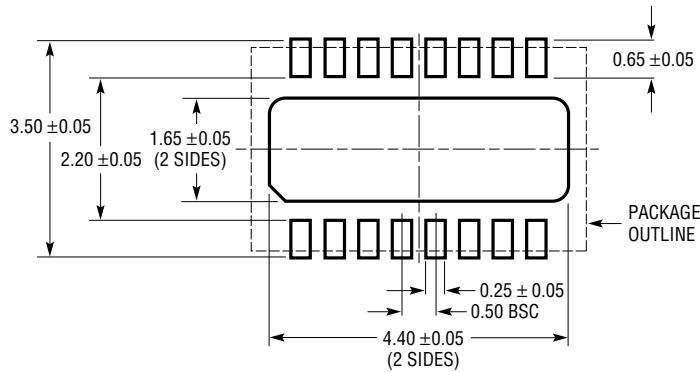

RECOMMENDED SOLDER PAD PITCH AND DIMENSIONS



- NOTE:
1. DRAWING PROPOSED TO BE MADE VARIATION OF VERSION (WJED-1) IN JEDEC PACKAGE OUTLINE MO-229
 2. DRAWING NOT TO SCALE
 3. ALL DIMENSIONS ARE IN MILLIMETERS
 4. DIMENSIONS OF EXPOSED PAD ON BOTTOM OF PACKAGE DO NOT INCLUDE MOLD FLASH. MOLD FLASH, IF PRESENT, SHALL NOT EXCEED 0.15mm ON ANY SIDE
 5. EXPOSED PAD SHALL BE SOLDER PLATED
 6. SHADED AREA IS ONLY A REFERENCE FOR PIN 1 LOCATION ON THE TOP AND BOTTOM OF PACKAGE

TYPICAL APPLICATION

Low Power V-to-F Converter

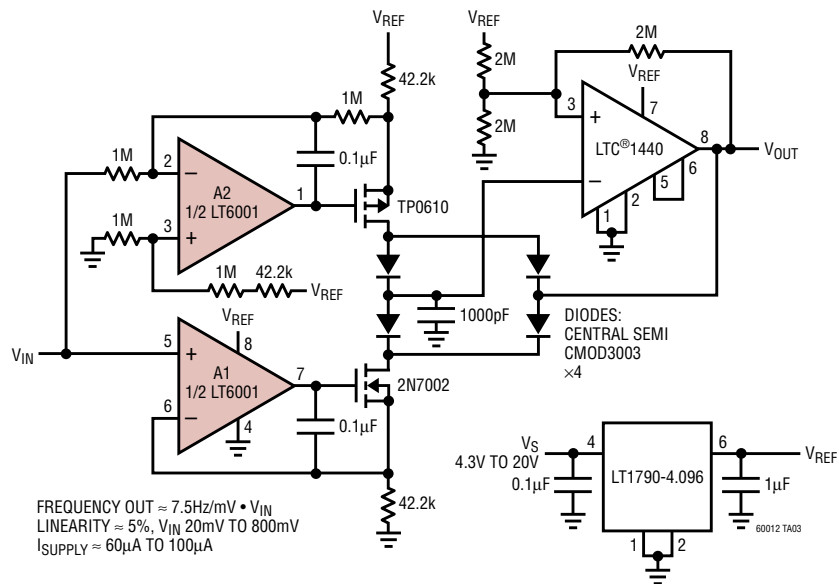

MUX Amplifier



MUX Amplifier Waveforms

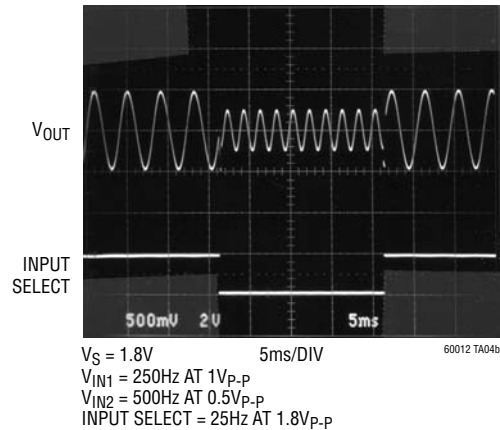

RELATED PARTS

| PART NUMBER | DESCRIPTION | COMMENTS |
|----------------------|--|---|
| LT2178/LT2179 | 17μA Dual/Quad Single Supply Op Amps | 120μV $V_{\text{OS(MAX)}}$, Gain Bandwidth = 60kHz |
| LT1490A/LT1491A | 50μA Dual/Quad Over-The-Top® Rail-to-Rail Input and Output Op Amps | 950μV $V_{\text{OS(MAX)}}$, Gain Bandwidth = 200kHz |
| LT1494/LT1495/LT1496 | 1.5μA Max Single/Dual/Quad Over-The-Top Precision Rail-to-Rail Input and Output Op Amps | 375μV $V_{\text{OS(MAX)}}$, Gain Bandwidth = 2.7kHz |
| LT1672/LT1673/LT1674 | 2μA Max, $A_{\text{V}} \geq 5$, Single/Dual/Quad Over-The-Top Precision Rail-to-Rail Input and Output Op Amps | Gain of 5 Stable, Gain Bandwidth = 12kHz |
| LT1782 | Micropower, Over-The-Top SOT-23 Rail-to-Rail Input and Output Op Amps | SOT-23, 800μV $V_{\text{OS(MAX)}}$, $I_{\text{S}} = 55\mu\text{A (Max)}$, Gain Bandwidth = 200kHz, Shutdown Pin |

Over-The-Top is a registered trademark of Linear Technology Corporation.

Mouser Electronics

Authorized Distributor

Click to View Pricing, Inventory, Delivery & Lifecycle Information:

[Analog Devices Inc.:](#)

[LT6001CDD#TRPBF](#) [LT6000IDCB](#) [LT6001IMS8](#) [LT6002CGN#TRPBF](#) [LT6002IGN#PBF](#) [LT6000IDCB#TRMPBF](#)
[LT6002IDHC](#) [LT6000IDCB#TRM](#) [LT6002CDHC#TR](#) [LT6002CGN](#) [LT6001IMS8#TR](#) [LT6001CMS8#PBF](#)
[LT6000CDCB#PBF](#) [LT6002CGN#TR](#) [LT6001CDD#TR](#) [LT6002CDHC#PBF](#) [LT6001CMS8#TR](#) [LT6001IMS8#PBF](#)
[LT6002IGN](#) [LT6001IDD](#) [LT6000IDCB#TRPBF](#) [LT6002CDHC#TRPBF](#) [LT6001IDD#TRPBF](#) [LT6000CDCB#TR](#)
[LT6000CDCB#TRPBF](#) [LT6001CMS8](#) [LT6001IMS8#TRPBF](#) [LT6002IGN#TR](#) [LT6000CDCB#TRM](#) [LT6002CDHC](#)
[LT6002CGN#PBF](#) [LT6001CMS8#TRPBF](#) [LT6002IDHC#TRPBF](#) [LT6001CDD#PBF](#) [LT6000IDCB#TR](#)
[LT6001IDD#PBF](#) [LT6002IDHC#PBF](#) [LT6000CDCB#TRMPBF](#) [LT6001CDD](#) [LT6000IDCB#PBF](#) [LT6002IGN#TRPBF](#)
[LT6002IDHC#TR](#) [LT6000CDCB](#) [LT6001IDD#TR](#)