

Offline Isolated Flyback LED Controller with Active PFC

FEATURES

- Isolated PFC LED Driver with Minimum Number of External Components
- TRIAC Dimmable
- V_{IN} and V_{OUT} Limited Only by External Components
- Active Power Factor Correction (Typical PFC > 0.97)
- Low Harmonic Content
- No Opto-Coupler Required
- Accurate Regulated LED Current ($\pm 5\%$ Typical)
- Open LED and Shorted LED Protection
- Thermally Enhanced 16-Lead MSOP Package

APPLICATIONS

- Offline 4W to 100W+ LED Applications
- High DC V_{IN} LED Applications

LT, LT, LTC, LTM, Linear Technology and the Linear logo are registered trademarks and True Color PWM is a trademark of Linear Technology Corporation. All other trademarks are the property of their respective owners. Patents pending.

DESCRIPTION

The **LT[®]3799** is an isolated flyback controller with power factor correction specifically designed for driving LEDs. The controller operates using critical conduction mode allowing the use of a small transformer. Using a novel current sensing scheme, the controller is able to deliver a well regulated current to the secondary side without using an opto-coupler. A strong gate driver is included to drive an external high voltage MOSFET. Utilizing an onboard multiplier, the LT3799 typically achieves power factors of 0.97. The $\overline{\text{FAULT}}$ pin provides notification of open and short LED conditions.

The LT3799 uses a micropower hysteretic start-up to efficiently operate at offline input voltages, with a third winding to provide power to the part. An internal LDO provides a well regulated supply for the part's internal circuitry and gate driver.

TYPICAL APPLICATION

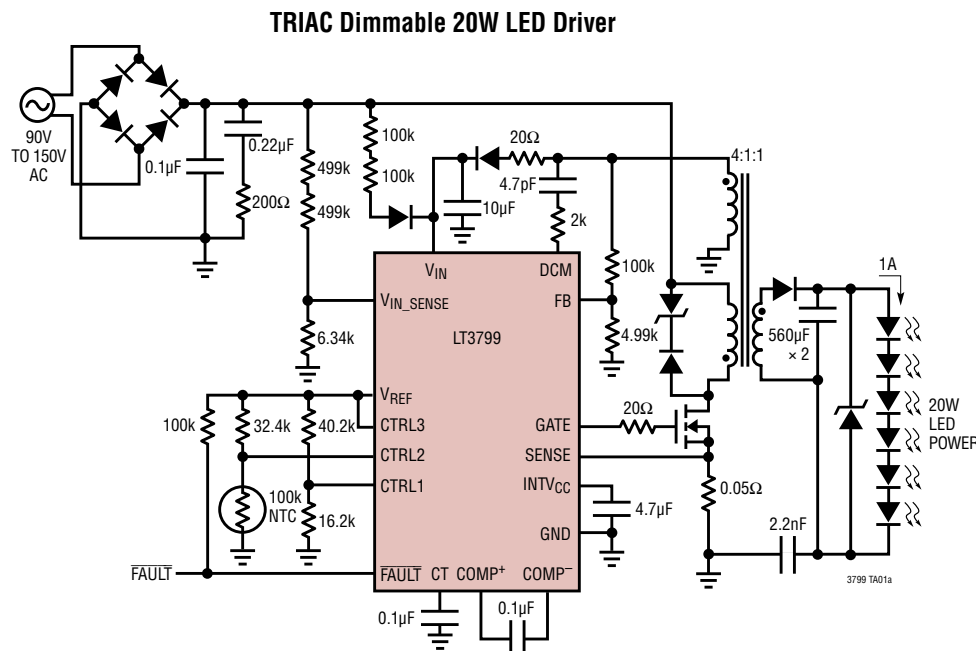

LED Current vs Input Voltage

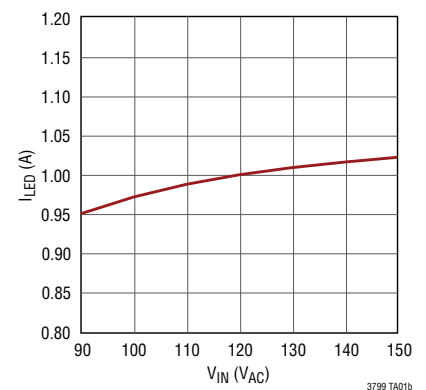

ABSOLUTE MAXIMUM RATINGS

(Note 1)

V_{IN} , FAULT	32V
GATE, INTV _{CC}	12V
CTRL1, CTRL2, CTRL3, V_{IN_SENSE} , COMP ⁻	4V
FB, CT, V_{REF} , COMP ⁺ ,	3V
SENSE	0.4V
DCM	±3mA
Maximum Junction Temperature	125°C
Operating Temperature Range (Note 2)	
LT3799E	-40°C to 125°C
LT3799I	-40°C to 125°C
Storage Temperature Range	-65°C to 150°C

PIN CONFIGURATION

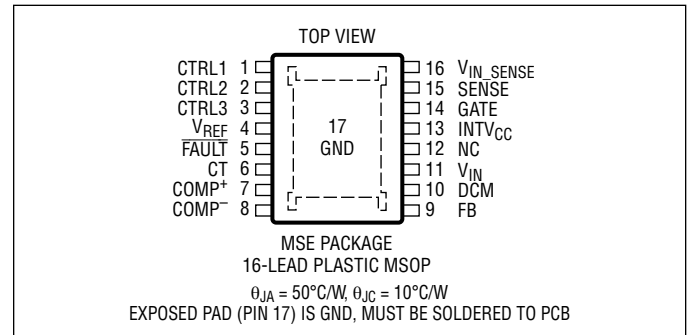

ORDER INFORMATION

(<http://www.linear.com/product/LT3799#orderinfo>)

LEAD FREE FINISH	TAPE AND REEL	PART MARKING*	PACKAGE DESCRIPTION	TEMPERATURE RANGE
LT3799EMSE#PBF	LT3799EMSE#TRPBF	3799	16-Lead Plastic MSOPE	-40°C to 125°C
LT3799IMSE#PBF	LT3799IMSE#TRPBF	3799	16-Lead Plastic MSOPE	-40°C to 125°C

Consult LTC Marketing for parts specified with wider operating temperature ranges. *The temperature grade is identified by a label on the shipping container.

For more information on lead free part marking, go to: <http://www.linear.com/leadfree/>

For more information on tape and reel specifications, go to: <http://www.linear.com/tapeandree/>

ELECTRICAL CHARACTERISTICS

The ● denotes the specifications which apply over the full operating temperature range, otherwise specifications are at $T_A = 25^\circ\text{C}$. $V_{IN} = 18\text{V}$, $\text{INTV}_{CC} = 11\text{V}$, unless otherwise noted.

PARAMETER	CONDITIONS	MIN	TYP	MAX	UNITS
V_{IN} Turn-On Voltage		22.2	23	24.2	V
V_{IN} Turn-Off Voltage		11.8	12.3	13.0	V
V_{IN} Hysteresis	$V_{TURNON} - V_{TURNOFF}$		10.7		V
V_{IN} Shunt Regulator Voltage	$I = 1\text{mA}$		25.0		V
V_{IN} Shunt Regulator Current Limit		15			mA
V_{IN} Quiescent Current	Before Turn-On	55	65	75	μA
	After Turn-On		70		μA
INTV _{CC} Quiescent Current	Before Turn-On	12	16	20.0	μA
	After Turn-On	1.5	1.2	2.6	mA
V_{IN_SENSE} Threshold	Turn-Off	30	65	90	mV
V_{IN_SENSE} Linear Range		0		1.3	V
V_{REF} Voltage	0μA Load	● 1.97	2	2.03	V
	200μA Load	● 1.95	1.98	2.03	V
Error Amplifier Voltage Gain	$\Delta V_{COMP+}/\Delta V_{COMP-}$, CTRL1 = 1V, CTRL2 = 2V, CTRL3 = 2V		100		V/V
Error Amplifier Transconductance	$\Delta I = 5\mu\text{A}$		50		μmhos

ELECTRICAL CHARACTERISTICS

The ● denotes the specifications which apply over the full operating temperature range, otherwise specifications are at $T_A = 25^\circ\text{C}$. $V_{IN} = 18\text{V}$, unless otherwise noted.

PARAMETER	CONDITIONS	MIN	TYP	MAX	UNITS
FB Pin Bias Current	(Note 3), $FB = 1\text{V}$		100	600	nA
CTRL1/CTRL2/CTRL3 Pin Bias Current	CTRL/CTRL2/CTRL3 = 1V			±25	nA
Maximum SENSE Current Limit Threshold		96	100	106	mV
SENSE Input Bias Current	Current Out of Pin, SENSE = 0V		15		μA
Current Loop Voltage Gain	$\Delta V_{CTRL}/\Delta V_{SENSE}$, 1000pF Cap from COMP+ to COMP-		21		V/V
CT Pin Charge Current			10		μA
CT Pin Discharge Current			200		nA
CT Pin Low Threshold	Falling Threshold		240		mV
CT Pin High Threshold	Rising Threshold		1.25		V
CT Pin Low Hysteresis			100		mV
FB Pin High Threshold		1.22	1.25	1.29	V
DCM Current Turn-On Threshold	Current Out of Pin		45		μA
Maximum Oscillator Frequency	COMP+ = 1.2V, $V_{IN_SENSE} = 1\text{V}$		300		kHz
Minimum Oscillator Frequency	COMP+ = 0V, V_{IN_SENSE}		25		kHz
Back-Up Oscillator Frequency			20		kHz

Linear Regulator

INTV _{CC} Regulation Voltage		9.8	10	10.4	V
Dropout ($V_{IN} - \text{INTV}_{CC}$)	INTV _{CC} = -10mA; Below V_{IN} Turn-Off Voltage		750	1150	mV
Current Limit	Below Undervoltage Threshold	12	25		mA
Current Limit	Above Undervoltage Threshold	80	120		mA

Gate Driver

t_r GATE Driver Output Rise Time	$C_L = 3300\text{pF}$, 10% to 90%		20		ns
t_f GATE Driver Output Fall Time	$C_L = 3300\text{pF}$, 90% to 10%		20		ns
GATE Output Low (V_{OL})				0.05	V
GATE Output High (V_{OH})		INTV _{CC} - 0.05			V

Note 1: Stresses beyond those listed under Absolute Maximum Ratings may cause permanent damage to the device. Exposure to any Absolute Maximum Rating condition for extended periods may affect device reliability and lifetime.

Note 2: The LT3799E is guaranteed to meet performance specifications from 0°C to 125°C junction temperature. Specifications over the -40°C

to 125°C operating junction temperature range are assured by design, characterization and correlation with statistical process controls. The LT3799I is guaranteed to meet performance specifications from -40°C to 125°C operating junction temperature.

Note 3: Current flows out of the FB pin.

TYPICAL PERFORMANCE CHARACTERISTICS

V_{IN} Start-Up Voltage vs Temperature

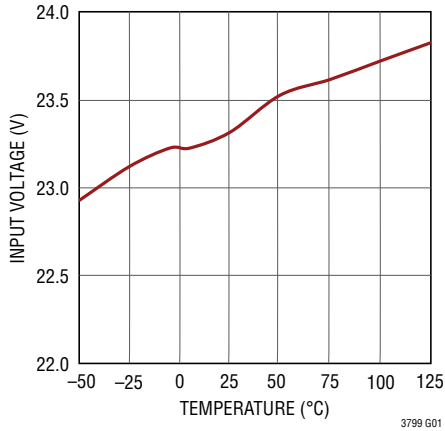

V_{IN} I_Q vs Temperature

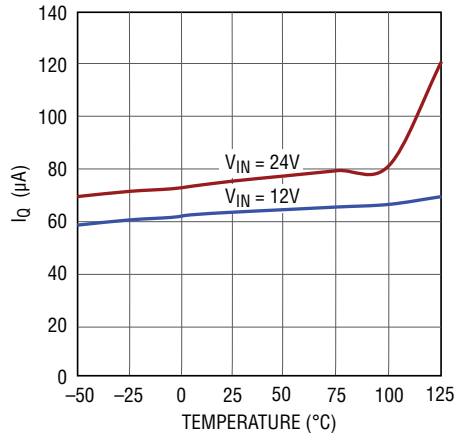

Input Voltage Hysteresis vs Temperature

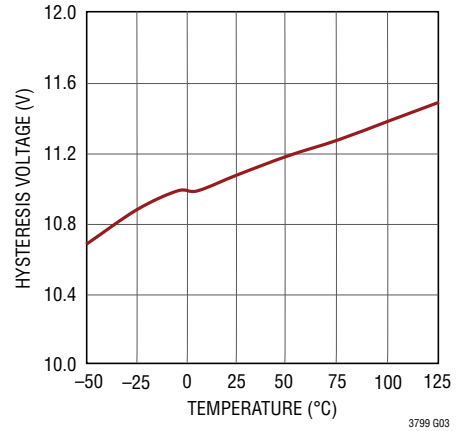

V_{REF} vs Temperature

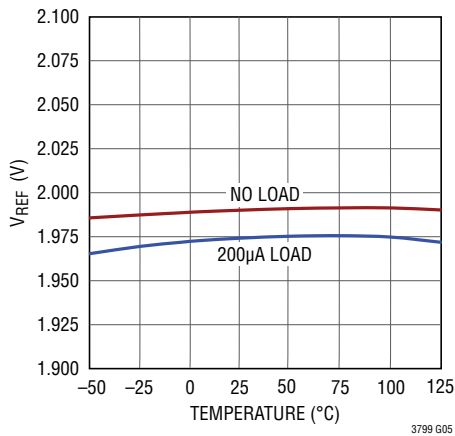

V_{REF} vs V_{IN}

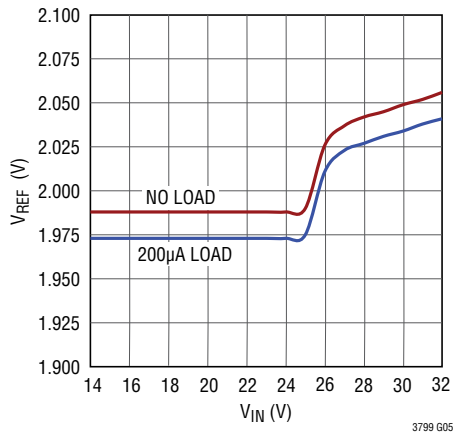

Current Limit vs Temperature

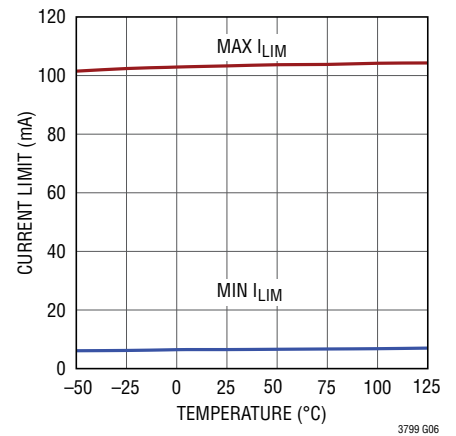

Maximum Oscillator Frequency vs Temperature

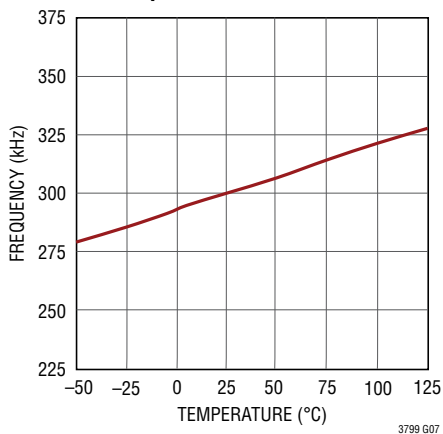

Minimum Oscillator Frequency vs Temperature

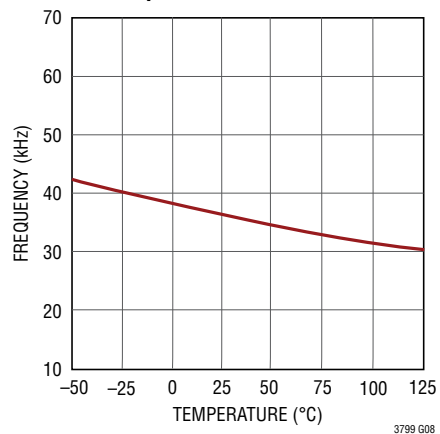

TYPICAL PERFORMANCE CHARACTERISTICS

CT Pin Charge Current vs Temperature

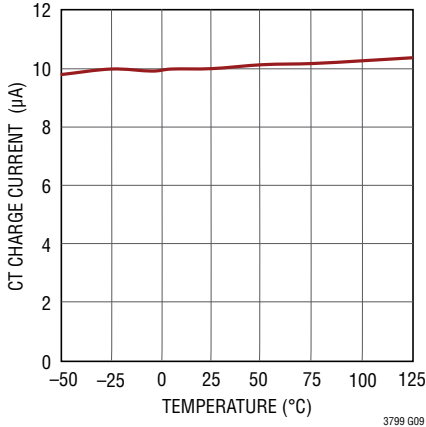

3799 G09

CT Pin Discharge Current vs Temperature

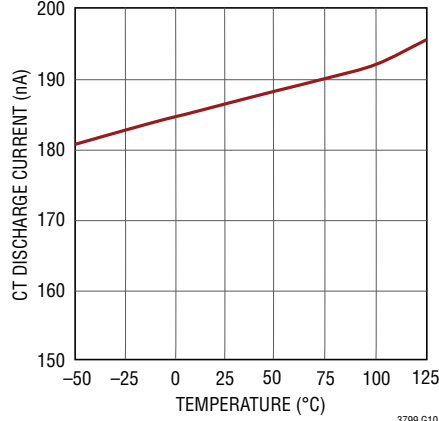

3799 G10

CT Pin Low Threshold vs Temperature

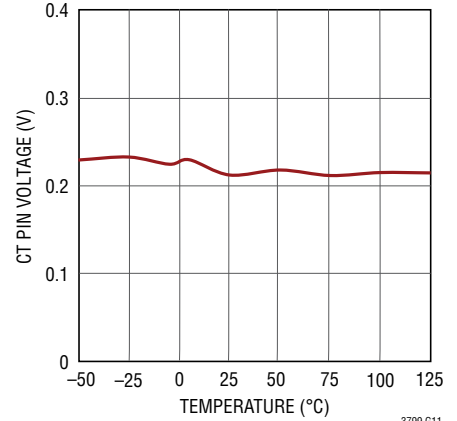

3799 G11

CT Pin High Threshold vs Temperature

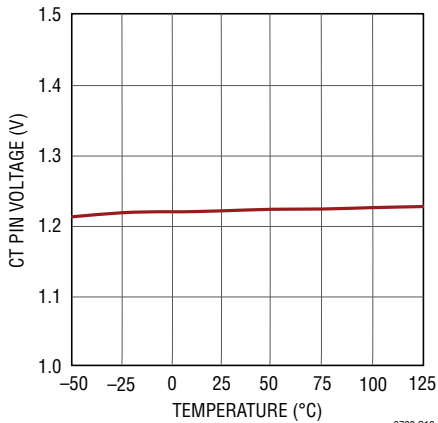

3799 G12

INTV_{CC} vs Temperature

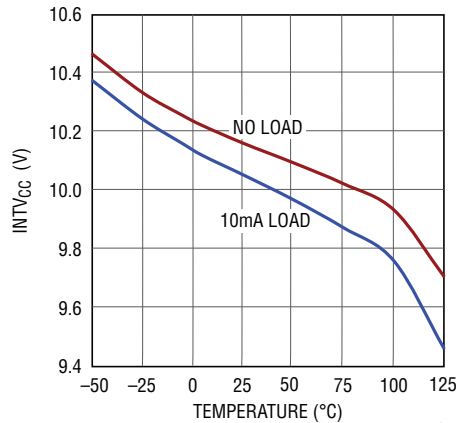

3799 G13

INTV_{CC} vs V_{IN}

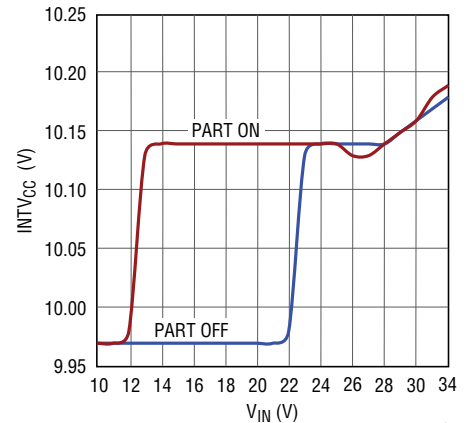

3799 G14

V_{IN} Shunt Voltage vs Temperature

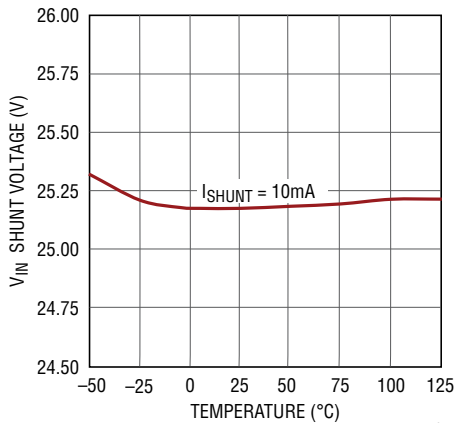

3799 G15

Maximum Shunt Current vs Temperature

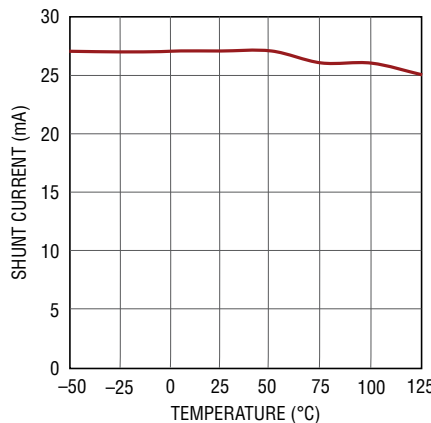

3799 G16

LED Current vs TRIAC Angle

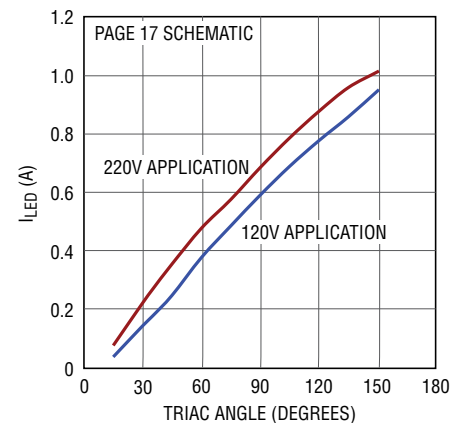

3799 G17

TYPICAL PERFORMANCE CHARACTERISTICS

LED Current vs Input Voltage

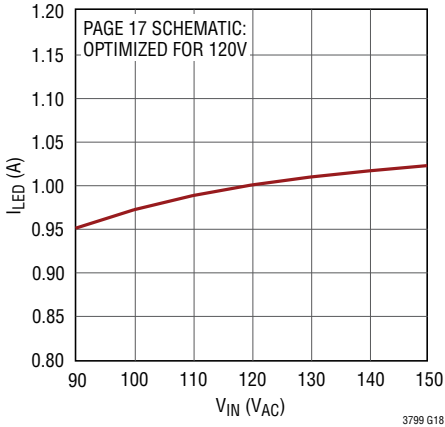

LED Current vs Input Voltage

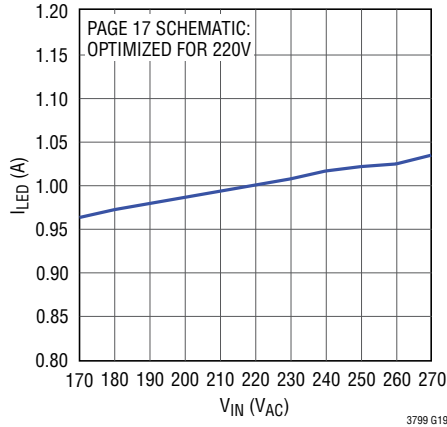

LED Current vs Input Voltage

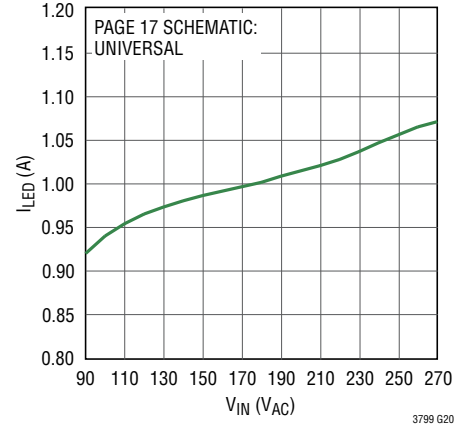

Power Factor vs Input Voltage

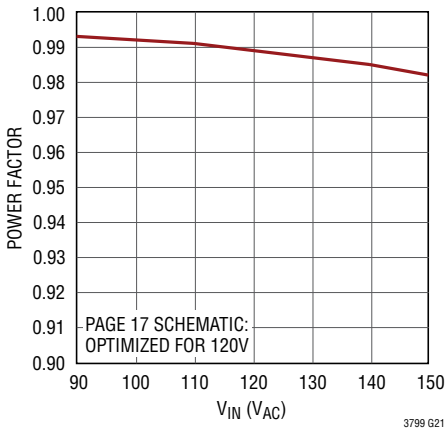

Power Factor vs Input Voltage

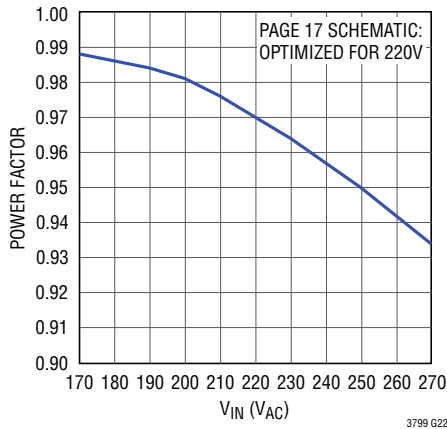

Power Factor vs Input Voltage

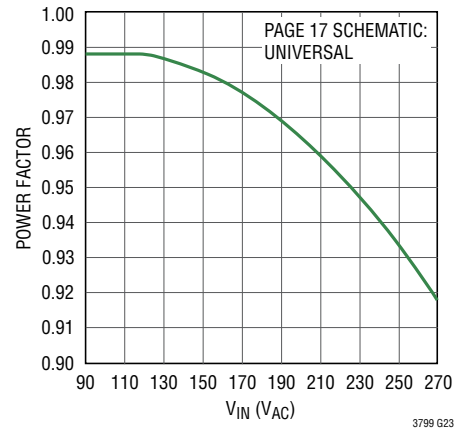

Efficiency vs Input Voltage

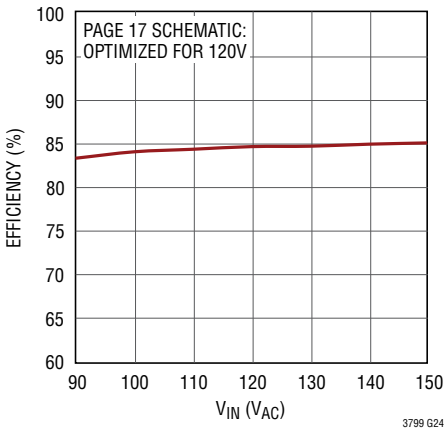

Efficiency vs Input Voltage

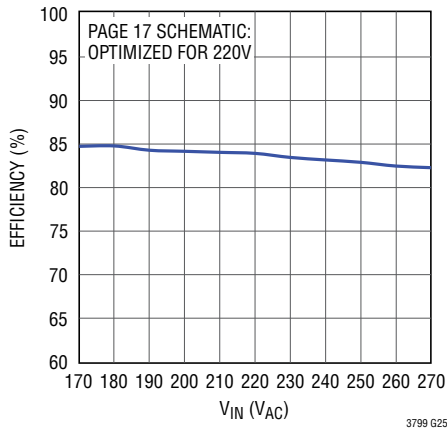

Efficiency vs Input Voltage

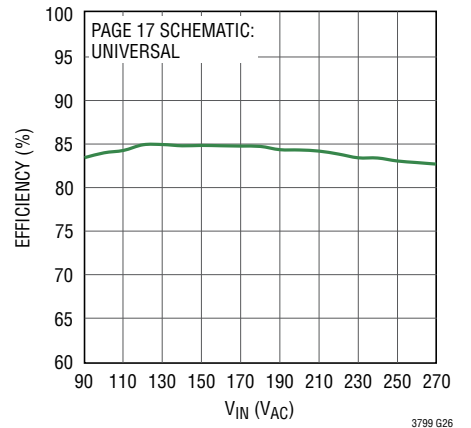

PIN FUNCTIONS

CTRL1, CTRL2, CTRL3 (Pin 1, Pin 2, Pin 3): Current Output Adjustment Pins. These pins control the output current. The lowest value of the three CTRL inputs is compared to the negative input of the operational amplifier. Due to the unique nature of the LT3799 control loop, the maximum current does not directly correspond to the V_{CTRL} voltages.

V_{REF} (Pin 4): Voltage Reference Output Pin, Typically 2V. This pin drives a resistor divider for the CTRL pin, either for analog dimming or for temperature limit/compensation of LED load. Can supply up to 200 μ A.

\overline{FAULT} (Pin 5): Fault Pin. An open-collector pull-down on \overline{FAULT} asserts if FB is greater than 1.25V with the CT pin higher than 1.25V.

CT (Pin 6): Timer Fault Pin. A capacitor is connected between this pin and ground to provide an internal timer for fault operations. During start-up, this pin is pulled to ground and then charged with a 10 μ A current. Faults related to the FB pin will be ignored until the CT pin reaches 1.25V. If a fault is detected, the controller will stop switching and begin to discharge the CT capacitor with a 200nA pull-down current. When the pin reaches 240mV, the controller will start to switch again.

COMP+, COMP- (Pin 7, Pin 8): Compensation Pins for Internal Error Amplifier. Connect a capacitor between these two pins to compensate the internal feedback loop.

FB (Pin 9): Voltage Loop Feedback Pin. FB is used to detect open LED conditions by sampling the third winding voltage. An open LED condition is reported if the CT pin and the FB pin are higher than 1.25V.

DCM (Pin 10): Discontinuous Conduction Mode Detection Pin. Connect a capacitor and resistor in series with this pin to the third winding.

V_{IN} (Pin 11): Input Voltage. This pin supplies current to the internal start-up circuitry and to the INTV_{CC} LDO. This pin must be locally bypassed with a capacitor. A 25V shunt regulator is internally connected to this pin.

INTV_{CC} (Pin 13): Regulated Supply for Internal Loads and GATE Driver. Supplied from V_{IN} and regulates to 10V (typical). INTV_{CC} must be bypassed with a 4.7 μ F capacitor placed close to the pin.

GATE (Pin 14): N-Channel MOSFET Gate Driver Output. Switches between INTV_{CC} and GND. This pin is pulled to GND during shutdown state.

SENSE (Pin 15): The Current Sense Input for the Control Loop. Kelvin connect this pin to the positive terminal of the switch current sense resistor, R_{SENSE} , and the source of the N-channel MOSFET. The negative terminal of the current sense resistor should be connected to the GND plane close to the IC.

V_{IN_SENSE} (Pin 16): Line Voltage Sense Pin. The pin is used for sensing the AC line voltage to perform power factor correction. Connect the output of a resistor divider from the line voltage to this pin. The voltage on this pin should be between 1.25V to 1.5V at the maximum input voltage.

GND (Exposed Pad Pin 17): Ground. The exposed pad of the package provides both electrical contact to ground and good thermal contact to the printed circuit board. The exposed pad must be soldered to the circuit board for proper operation.

BLOCK DIAGRAM

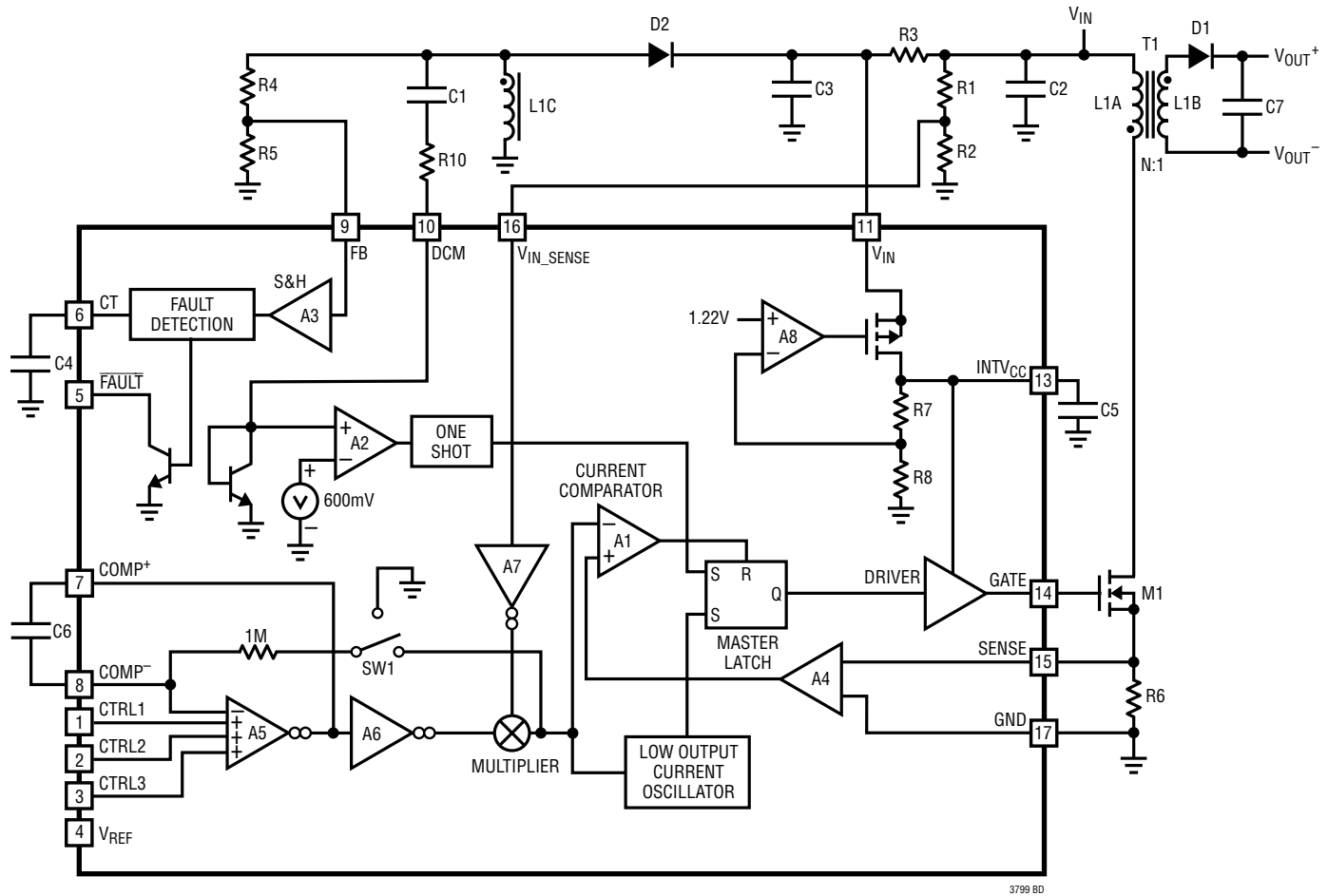

OPERATION

The LT3799 is a current mode switching controller IC designed specifically for generating an average current output in an isolated flyback topology. The special problem normally encountered in such circuits is that information relating to the output voltage and current on the isolated secondary side of the transformer must be communicated to the primary side in order to maintain regulation. Historically, this has been done with an opto-isolator. The LT3799 uses a novel method of using the external MOSFETs peak current information from the sense resistor to calculate the output current of a flyback converter without the need of an opto-coupler. In addition, it also detects open LED conditions by examining the third winding voltage when the main power switch is off.

Power factor has become an important specification for lighting. A power factor of one is achieved if the current drawn is proportional to the input voltage. The LT3799 modulates the peak current limit with a scaled version of the input voltage. This technique provides power factors of 0.97 or greater.

The Block Diagram shows an overall view of the system. The external components are in a flyback topology configuration. The third winding senses the output voltage and also supplies power to the part in steady-state operation. The V_{IN} pin supplies power to an internal LDO that generates 10V at the $INTV_{CC}$ pin. The novel control circuitry consists of an error amplifier, a multiplier, a transmission

OPERATION

gate, a current comparator, a low output current oscillator and a master latch, which will be explained in the following sections. The part also features a sample-and-hold to detect open LED conditions, along with a FAULT pin. A comparator is used to detect discontinuous conduction mode (DCM) with a cap connected to the third winding. The part features a 1.9A gate driver.

The LT3799 employs a micropower hysteretic start-up feature to allow the part to work at any combination of input and output voltages. In the Block Diagram, R3 is used to stand off the high voltage supply voltage. The internal LDO starts to supply current to the INTV_{CC} when V_{IN} is above 23V. The V_{IN} and INTV_{CC} capacitors are charged by the current from R3. When V_{IN} exceeds 23V and INTV_{CC} is in regulation at 10V, the part will begin to charge the CT pin with 10 μ A. Once the CT pin reaches 340mV, switching begins. The V_{IN} pin has 10.7V of hysteresis to allow for plenty of flexibility with the input and output capacitor values. The third winding provides power to V_{IN} when its voltage is higher than the V_{IN} voltage. A voltage shunt is provided for fault protection and can sink up to 15mA of current when V_{IN} is over 25V.

During a typical cycle, the gate driver turns the external MOSFET on and a current flows through the primary winding. This current increases at a rate proportional to the input voltage and inversely proportional to the magnetizing inductance of the transformer. The control loop determines the maximum current and the current comparator turns the switch off when the current level is reached. When the switch turns off, the energy in the core of the transformer flows out the secondary winding through the output diode, D1. This current decreases at a rate proportional to the output voltage. When the current decreases to zero, the output diode turns off and voltage across the secondary winding starts to oscillate from the parasitic capacitance and the magnetizing inductance of the transformer. Since all windings have the same voltage across them, the third winding rings too. The capacitor connected to the DCM pin, C1, trips the comparator, A2, which serves as a dv/dt detector, when the ringing occurs. This timing information is used to calculate the output current (description to follow). The dv/dt detector waits

for the ringing waveform to reach its minimum value and then the switch turns back on. This switching behavior is similar to zero volt switching and minimizes the amount of energy lost when the switch is turned back on, improving efficiency as much as 5%. Since this part operates on the edge of continuous conduction mode and discontinuous conduction mode, this operating mode is called critical conduction mode (or boundary conduction mode).

Primary-Side Current Control Loop

The CTRL1/CTRL2/CTRL3 pins control the output current of the flyback controller. To simplify the loop, assume the V_{IN_SENSE} pin is held at a constant voltage above 1V, eliminating the multiplier from the control loop. The error amplifier, A5, is configured as an integrator with the external capacitor, C6. The COMP⁺ node voltage is converted to a current into the multiplier with the V/I converter, A6. Since A7's output is constant, the output of the multiplier is proportional to A6 and can be ignored. The output of the multiplier controls the peak current with its connection to the current comparator, A1. The output of the multiplier is also connected to the transmission gate, SW1. The transmission gate, SW1, turns on when the secondary current flows to the output capacitor. This is called the flyback period (when the output diode D1 is on). The current through the 1M resistor gets integrated by A5. The lowest CTRL input is equal to the negative input of A5 in steady state.

A current output regulator normally uses a sense resistor in series with the output current and uses a feedback loop to control the peak current of the switching converter. In this isolated case the output current information is not available, so instead the LT3799 calculates it using the information available on the primary side of the transformer. The output current may be calculated by taking the average of the output diode current. As shown in Figure 1, the diode current is a triangle waveform with a base of the flyback time and a height of the peak secondary winding current. In a flyback topology, the secondary winding current is N times the primary winding current, where N is the primary to secondary winding ratio. Instead of taking the area of the triangle, think of it as a pulse width modulation (PWM) waveform. During the flyback time, the average current is half the peak secondary winding

OPERATION

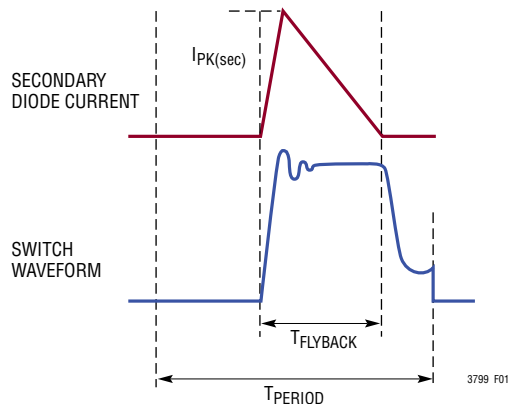

Figure 1. Secondary Diode Current and Switch Waveforms

current and zero during the rest of the cycle. The equation for expressing the output current is:

$$I_{OUT} = 0.5 \cdot I_{PK} \cdot N \cdot D'$$

where D' is equal to the percentage of the cycle represented by the flyback time.

The LT3799 has access to both the primary winding current, the input to the current comparator, and when the flyback time starts and ends. Now the output current can be calculated by averaging a PWM waveform with the height of the current limit and the duty cycle of the flyback time over the entire cycle. In the feedback loop previously described, the input to the integrator is such a waveform. The integrator adjusts the peak current until the calculated output current equals the control voltage. If the calculated output current is low compared to the control pin, the error amplifier increases the voltage on the COMP⁺ node, thus increasing the current comparator input.

When the V_{IN_SENSE} voltage is connected to a resistor divider of the supply voltage, the current limit is proportional to the supply voltage if COMP⁺ is held constant. The output of the error amplifier is multiplied with the V_{IN_SENSE} pin voltage. If the LT3799 is configured with a fast control loop, slower changes from the V_{IN_SENSE} pin will not interfere with the current limit or the output current. The COMP⁺ pin will adjust to the changes of the V_{IN_SENSE} . The only way for the multiplier to function properly is to set the control loop to be an order of magnitude slower than the fundamental frequency of the V_{IN_SENSE} signal. In the offline case, the fundamental frequency of the supply

voltage is 120Hz, so the control loop unity gain frequency needs to be set less than approximately 120Hz. Without a large amount of energy storage on the secondary side, the output current is affected by the supply voltage changes, but the DC component of the output current is accurate.

TRIAC Dimming Features

The LT3799 incorporates some special features that aid in the design of an offline LED current source when used with a TRIAC dimmer. TRIAC dimmers are not ideal switches when turned off and allow milliamps of current to flow through them. This is an issue if used with a low quiescent part such as the LT3799. Instead of turning the main power MOSFET off when the TRIAC is off, this power device is kept on and sinks the current to properly load the TRIAC. When the TRIAC turns on, the V_{IN_SENSE} pin detects this and enables the loop, but the current comparator is always enabled and turns the switch off if it is tripped.

Start-Up

The LT3799 uses a hysteretic start-up to operate from high offline voltages. A resistor connected to the supply voltage protects the part from high voltages. This resistor is connected to the V_{IN} pin on the part and also to a capacitor. When the resistor charges the part up to 23V and $INTV_{CC}$ is in regulation at 10V, the part begins to charge the CT pin to 340mV and then starts to switch. The resistor does not provide power for the part in steady state, but relies on the capacitor to start-up the part, then the third winding begins to provide power to the V_{IN} pin along with the resistor. An internal voltage clamp is attached to the V_{IN} pin to prevent the resistor current from allowing V_{IN} to go above the absolute maximum voltage of the pin. The internal clamp is set at 25V and is capable of 28mA (typical) of current at room temperature. But, ideally, the resistor connected between the input supply and the V_{IN} pin should be chosen so that less than 10mA is being shunted by this internal clamp.

CT Pin and Faults

The CT pin is a timing pin for the fault circuitry. When the input voltages are at the correct levels, the CT pin sources 10μA of current. When the CT pin reaches 340mV, the part

OPERATION

begins to switch. The output voltage information from the FB pin is sampled but ignored until the CT pin reaches 1.25V. When this occurs, if the FB pin is above 1.25V, the fault flag pulls low. The FAULT pin is meant to be used with a large pull-up resistor to the INTV_{CC} pin or another supply. The CT pin begins to sink 200nA of current. When the CT pin goes below 240mV, the part will re-enable itself, begin to switch, and start to source 10μA of current to the CT pin but not remove the fault condition. When the CT pin reaches 1.25V and FB is below 1.25V, the FAULT pin will no longer pull low and switching will continue. If not below 1.25V, the process repeats itself.

Programming Output Current

The maximum output current depends on the supply voltage and the output voltage in a flyback topology. With the V_{IN_SENSE} pin connected to 1V and a DC supply voltage, the maximum output current is determined at the minimum supply voltage, and the maximum output voltage using the following equation:

$$I_{OUT(MAX)} = 2 \cdot (1-D) \cdot \frac{N}{42 \cdot R_{SENSE}}$$

where

$$D = \frac{V_{OUT} \cdot N}{V_{OUT} \cdot N + V_{IN}}$$

The maximum control voltage to achieve this maximum output current is 2V • (1-D).

It is suggested to operate at 95% of these values to give margin for the part's tolerances.

When designing for power factor correction, the output current waveform is going to have a half sine wave squared shape and will no longer be able to provide the above currents. By taking the integral of a sine wave squared over half a cycle, the average output current is found to be half the value of the peak output current. In this case, the recommended maximum average output current is as follows:

$$I_{OUT(MAX)} = 2 \cdot (1-D) \cdot \frac{N}{42 \cdot R_{SENSE}} \cdot 47.5\%$$

where

$$D = \frac{V_{OUT} \cdot N}{V_{OUT} \cdot N + V_{IN}}$$

The maximum control voltage to achieve this maximum output current is (1-D) • 47.5%.

For control voltages below the maximum, the output current is equal to the following equation:

$$I_{OUT} = CTRL \cdot \frac{N}{42 \cdot R_{SENSE}}$$

The V_{REF} pin supplies a 2V reference voltage to be used with the control pins. To set an output current, a resistor divider is used from the 2V reference to one of the control pins. The following equation sets the output current with a resistor divider:

$$R1 = R2 \left(\frac{2N}{42 \cdot I_{OUT} \cdot R_{SENSE}} - 1 \right)$$

where R1 is the resistor connected to the V_{REF} pin and the CTRL pin and R2 is the resistor connected to the CTRL pin and ground.

When used with an AC input voltage, the LT3799 senses when the V_{IN_SENSE} goes below 65mV and above 65mV for detecting when the TRIAC is off. During this low input voltage time, the output current regulation loop is off but the part still switches. This helps with output current regulation with a TRIAC but introduces a line regulation error. When V_{IN_SENSE} is low, very little power is being delivered to the output and since the output current regulation loop is off, this time period needs to be accounted for in setting the output current. This time period slightly varies with line voltage. Figure 2 shows the correction factor in selecting the resistor divider resistors. When used with AC, the following equation should be used with the correction factor:

$$I_{OUT} = CTRL \cdot \frac{N}{42 \cdot R_{SENSE} \cdot CF}$$

$$R1 = R2 \left(\frac{2N}{42 \cdot I_{OUT} \cdot R_{SENSE} \cdot CF} - 1 \right)$$

OPERATION

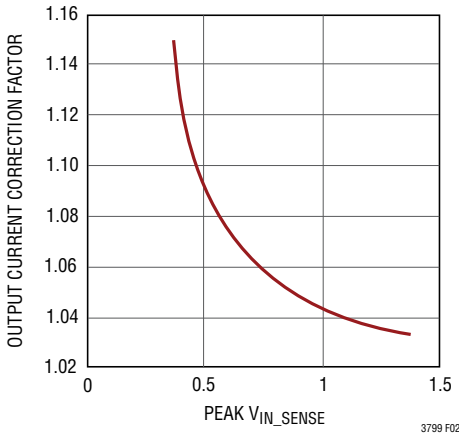

Figure 2. Output Current Correction Factor

where CF is the output current correction factor on the Y-axis in Figure 2.

Critical Conduction Mode Operation

Critical conduction mode is a variable frequency switching scheme that always returns the secondary current to zero with every cycle. The LT3799 relies on boundary mode and discontinuous mode to calculate the critical current because the sensing scheme assumes the secondary current returns to zero with every cycle. The DCM pin uses a fast current input comparator in combination with a small capacitor to detect dv/dt on the third winding. To eliminate false tripping due to leakage inductance ringing, a blanking time of between 600ns and 2.25 μ s is applied after the switch turns off, depending on the current limit. The detector looks for 40 μ A of current through the DCM pin due to falling voltage on the third winding when the secondary diode turns off. This detection is important since the output current is calculated using this comparator's output. This is not the optimal time to turn the switch on because the switch voltage is still close to $V_{IN} + V_{OUT} \cdot N$ and would waste all the energy stored in the parasitic capacitance on the switch node. Discontinuous ringing begins when the secondary current reaches zero and the energy in the parasitic capacitance on the switch node transfers to the input capacitor. This is a second-order network composed of the parasitic capacitance on the switch node and the magnetizing inductance of the

primary winding of the transformer. The minimum voltage of the switch node during this discontinuous ring is $V_{IN} - V_{OUT} \cdot N$. The LT3799 turns the switch back on at this time, during the discontinuous switch waveform, by sensing when the slope of the switch waveform goes from negative to positive using the dv/dt detector. This switching technique may increase efficiency by 5%.

Sense Resistor Selection

The resistor, R_{SENSE} , between the source of the external N-channel MOSFET and GND should be selected to provide an adequate switch current to drive the application without exceeding the current limit threshold .

For applications without power factor correction, select a resistor according to:

$$R_{SENSE} = \frac{2(1-D)N}{I_{OUT} \cdot 42} \cdot 95\%$$

where

$$D = \frac{V_{OUT} \cdot N}{V_{OUT} \cdot N + V_{IN}}$$

For applications with power factor correction, select a resistor according to:

$$R_{SENSE} = \frac{2(1-D)N}{I_{OUT} \cdot 42} \cdot 47.5\%$$

where

$$D = \frac{V_{OUT} \cdot N}{V_{OUT} \cdot N + V_{IN}}$$

Minimum Current Limit

The LT3799 features a minimum current limit of approximately 7% of the peak current limit. This is necessary when operating in critical conduction mode since low current limits would increase the operating frequency to a very high frequency. The output voltage sensing circuitry needs a minimum amount of flyback waveform time to sense the output voltage on the third winding. The time needed is 350ns. The minimum current limit allows the use of smaller

OPERATION

transformers since the magnetizing primary inductance does not need to be as high to allow proper time to sample the output voltage information.

Errors Affecting Current Output Regulation

There are a few factors affecting the regulation of current in a manufacturing environment along with some systematic issues. The main manufacturing issues are the winding turns ratio and the LT3799 control loop accuracy. The winding turns ratio is well controlled by the transformer manufacturer's winding equipment, but most transformers do not require a tight tolerance on the winding ratio. We have worked with transformer manufacturers to specify $\pm 1\%$ error for the turns ratio. Just like any other LED driver, the part is tested and trimmed to eliminate offsets in the control loop and an error of $\pm 3\%$ is specified at 80% of the maximum output current. The error grows larger as the LED current is decreased from the maximum output current. At half the maximum output current, the error doubles to $\pm 6\%$.

There are a number of systematic offsets that may be eliminated by adjusting the control voltage from the ideal voltage. It is difficult to measure the flyback time with complete accuracy. If this time is not accurate, the control voltage needs to be adjusted from the ideal value to eliminate the offset but this error still causes line regulation errors. If the supply voltage is lowered, the time error becomes a smaller portion of the switching cycle period so the offset becomes smaller and vice versa. This error may be compensated for at the primary supply voltage, but this does not solve the problem completely for other supply voltages. Another systematic error is that the current comparator cannot instantaneously turn off the main power device. This delay time leads to primary current overshoot. This overshoot is less of a problem when the output current is close to its maximum, since the overshoot is only related to the slope of the primary current and not the current level. The overshoot is proportional to the supply voltage, so again this affects the line regulation.

Universal Input

The LT3799 operates over the universal input range of $90V_{AC}$ to $265V_{AC}$. Output current regulation error may

be minimized by using two application circuits for the wide input range: one optimized for $120V_{AC}$ and another optimized for $220V_{AC}$. The first application pictured in the Typical Applications section shows three options: universal input, $120V_{AC}$, and $220V_{AC}$. The circuit varies by three resistors. In the Typical Performance Characteristics section, the LED Current vs V_{IN} graphs show the output current line regulation for all three circuits.

Selecting Winding Turns Ratio

Boundary mode operation gives a lot of freedom in selecting the turns ratio of the transformer. We suggest to keep the duty cycle low, lower N_{PS} , at the maximum input voltage since the duty cycle will increase when the AC waveform is decreases to zero volts. A higher N_{PS} increases the output current while keeping the primary current limit constant. Although this seems to be a good idea, it comes at the expense of a higher RMS current for the secondary-side diode which might not be desirable because of the primary side MOSFET's superior performance as a switch. A higher N_{PS} does reduce the voltage stress on the secondary-side diode while increasing the voltage stress on the primary-side MOSFET. If switching frequency at full output load is kept constant, the amount of energy delivered per cycle by the transformer also stays constant regardless of the N_{PS} . Therefore, the size of the transformer remains the same at practical N_{PS} 's. Adjusting the turns ratio is a good way to find an optimal MOSFET and diode for a given application.

Switch Voltage Clamp Requirement

Leakage inductance of an offline transformer is high due to the extra isolation requirement. The leakage inductance energy is not coupled to the secondary and goes into the drain node of the MOSFET. This is problematic since 400V and higher rated MOSFETs cannot always handle this energy by avalanche. Therefore the MOSFET needs protection. A transient voltage suppressor (TVS) and diode are recommended for all offline application and connected, as shown in Figure 3. The TVS device needs a reverse breakdown voltage greater than $(V_{OUT} + V_f) * N$ where V_{OUT} is the output voltage of the flyback converter, V_f is the secondary diode forward voltage, and N is the turns ratio.

OPERATION

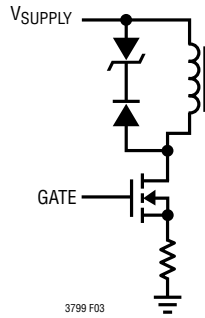

Figure 3. Clamp

Transformer Design Considerations

Transformer specification and design is a critical part of successfully applying the LT3799. In addition to the usual list of caveats dealing with high frequency isolated power supply transformer design, the following information should be carefully considered. Since the current on the secondary side of the transformer is inferred by the current sampled on the primary, the transformer turns ratio must be tightly controlled to ensure a consistent output current.

A tolerance of $\pm 5\%$ in turns ratio from transformer to transformer could result in a variation of more than $\pm 5\%$ in output regulation. Fortunately, most magnetic component manufacturers are capable of guaranteeing a turns ratio tolerance of 1% or better. Linear Technology has worked with several leading magnetic component manufacturers to produce predesigned flyback transformers for use with

the LT3799. Table 1 shows the details of several of these transformers.

Loop Compensation

The current output feedback loop is an integrator configuration with the compensation capacitor between the negative input and output of the operational amplifier. This is a one-pole system therefore a zero is not needed in the compensation. For offline applications with PFC, the crossover should be set an order of magnitude lower than the line frequency of 120Hz or 100Hz. In a typical application, the compensation capacitor is 0.1 μ F.

In non-PFC applications, the crossover frequency may be increased to improve transient performance. The desired crossover frequency needs to be set an order of magnitude below the switching frequency for optimal performance.

MOSFET and Diode Selection

With a strong 1.9A gate driver, the LT3799 can effectively drive most high voltage MOSFETs. A low Q_g MOSFET is recommended to maximize efficiency. In most applications, the $R_{DS(ON)}$ should be chosen to limit the temperature rise of the MOSFET. The drain of the MOSFET is stressed to $V_{OUT} \cdot N_{PS} + V_{IN}$ during the time the MOSFET is off and the secondary diode is conducting current. But in most applications, the leakage inductance voltage spike exceeds this voltage. The voltage of this stress is determined

Table 1. Predesigned Transformers—Typical Specifications, Unless Otherwise Noted

TRANSFORMER PART NUMBER	SIZE (L x W x H)	L _{PRI} (μ H)	N _{PSA} (N _P :N _S :N _A)	R _{PRI} (m Ω)	R _{SEC} (m Ω)	MANUFACTURER	TARGET APPLICATION (V _{OUT} /I _{OUT})
JA4429	21.1mm x 21.1mm x 17.3mm	400	1:0.24:0.24	252	126	Coilcraft	22V/1A
7508110210	15.75mm x 15mm x 18.5mm	2000	6.67:1:1.67	5100	165	Würth Elektronik	10V/0.4A
750813002	15.75mm x 15mm x 18.5mm	2000	20:1.0:5.0	6100	25	Würth Elektronik	3.8V/1.1A
750811330	43.2mm x 39.6mm x 30.5mm	300	6:1.0:1.0	150	25	Würth Elektronik	18V/5A
750813144	16.5mm x 18mm x 18mm	600	4:1:0.71	2400	420	Würth Elektronik	28V/0.5A
750813134	16.5mm x 18mm x 18mm	600	8:1:1.28	1850	105	Würth Elektronik	14V/1A
750811291	31mm x 31mm x 25mm	400	1:1:0.24	550	1230	Würth Elektronik	85V/0.4A
750813390	43.18mm x 39.6mm x 30.48mm	100	1:1:0.22	150	688	Würth Elektronik	90V/1A
750811290	31mm x 31mm x 25mm	460	1:1:0.17	600	560	Würth Elektronik	125V/0.32A
X-11181-002	23.5mm x 21.4mm x 9.5mm	500	72:16:10	1000	80	Premo	30V/0.5A

3799fb

OPERATION

by the switch voltage clamp. Always check the switch waveform with an oscilloscope to make sure the leakage inductance voltage spike is below the breakdown voltage of the MOSFET. A transient voltage suppressor and diode are slower than the leakage inductance voltage spike, therefore causing a higher voltage than calculated.

The secondary diode stress may be as much as $V_{OUT} + 2 \cdot V_{IN}/N_{PS}$ due to the anode of the diode ringing with the secondary leakage inductance. An RC snubber in parallel with the diode eliminates this ringing, so that the reverse voltage stress is limited to $V_{OUT} + V_{IN}/N_{PS}$. With a high N_{PS} and output current greater than 3A, the I_{RMS} through the diode can become very high and a low forward drop Schottky is recommended.

Discontinuous Mode Detection

The discontinuous mode detector uses AC-coupling to detect the ringing on the third winding. A 10pF capacitor with a 500Ω resistor in series is recommended in most designs. Depending on the amount of leakage inductance ringing, an additional current may be needed to prevent false tripping from the leakage inductance ringing. A resistor from $INTV_{CC}$ to the DCM pin adds this current. Up to an additional 100μA of current may be needed in some cases. The DCM pin is roughly 0.7V, therefore the resistor value is selected using the following equation:

$$R = \frac{10V - 0.7V}{I}$$

where I is equal to the additional current into the DCM pin.

Power Factor Correction/Harmonic Content

The LT3799 attains high power factor and low harmonic content by making the peak current of the main power

switch proportional to the line voltage by using an internal multiplier. A power factor of >0.97 is easily attainable for most applications by following the design equations in this datasheet. With proper design, LT3799 applications meet IEC 6100-3-2 Class C harmonic standards.

Protection from Open LED and Shorted LED Faults

The LT3799 detects output overvoltage conditions by looking at the voltage on the third winding. The third winding voltage is proportional to the output voltage when the main power switch is off and the secondary diode is conducting current. Sensing the output voltage requires delivering power to the output. Using the CT pin, the part turns off switching when a overvoltage condition occurs and re-checks to see if the overvoltage condition has cleared, as described in "CT Pin and Faults" in the Operation section. This greatly reduces the output current delivered to the output but a Zener is required to dissipate 2% of the set output current during an open LED condition. The Zener diode's voltage needs to be 10% higher than the output voltage set by the resistor divider connected to the FB pin. Multiple Zener diodes in series may be needed for higher output power applications to keep the Zener's temperature within the specification.

During a shorted LED condition, the LT3799 operates at the minimum operating frequency. In normal operation, the third winding provides power to the IC, but the third winding voltage is zero during a shorted LED condition. This causes the part's V_{IN} UVLO to shutdown switching. The part starts switching again when V_{IN} has reached its turn-on voltage.

TYPICAL APPLICATIONS

Universal TRIAC Dimmable 20W LED Driver

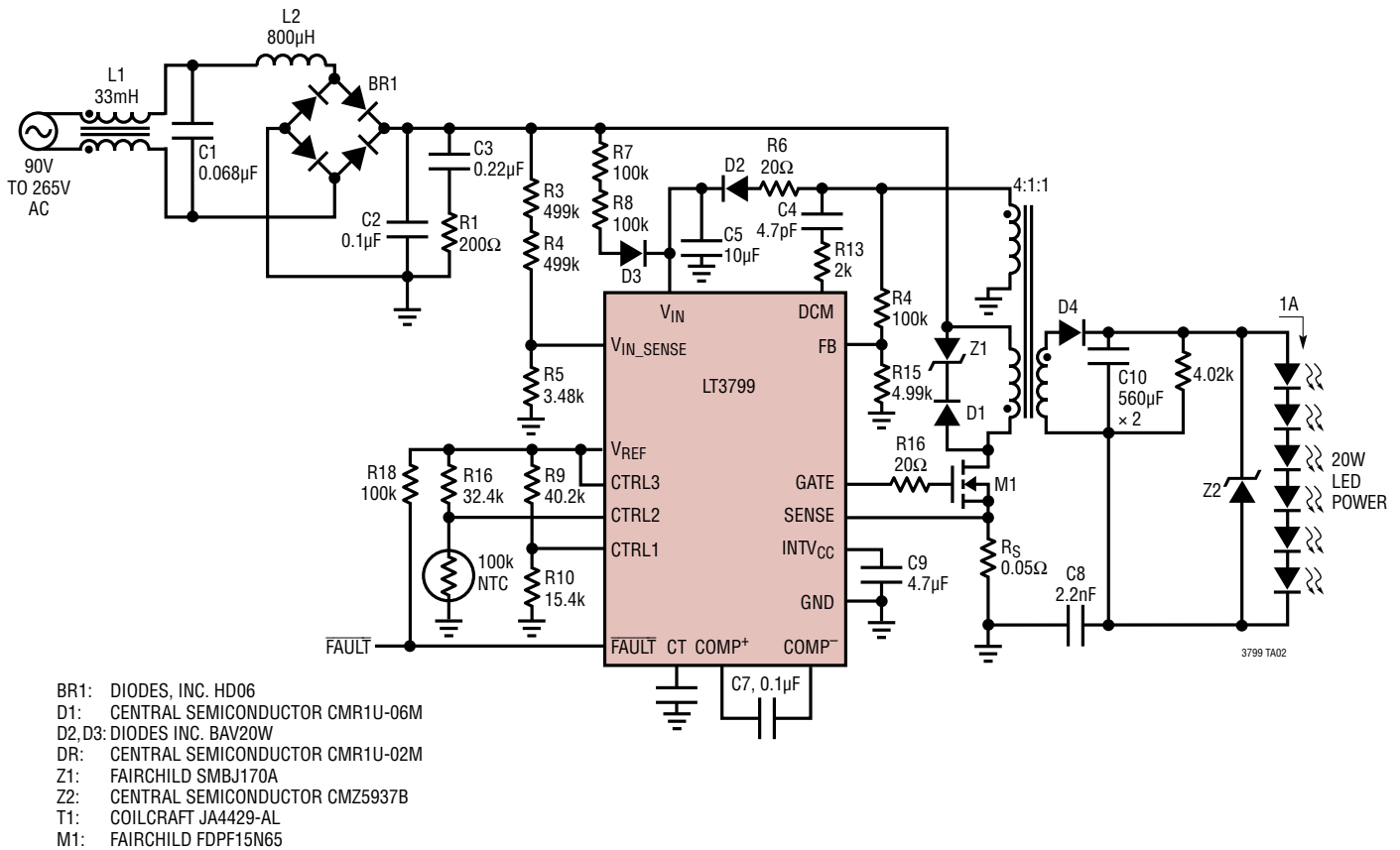

Component Values for Input Voltage Ranges

	R5 (Ω)	R10 (Ω)	R _S (Ω)	R1 (Ω)	C2 (μF)	C3 (μF)
Optimized for 110V	6.34k	16.2k	0.05	200	0.1	0.22
Optimized for 220V	3.48k	24.9k	0.075	1.00k	0.033	0.1
Universal	3.48k	15.4k	0.05	200	0.1	0.22

TYPICAL APPLICATIONS

Universal Input TRIAC Dimmable 4W LED Driver

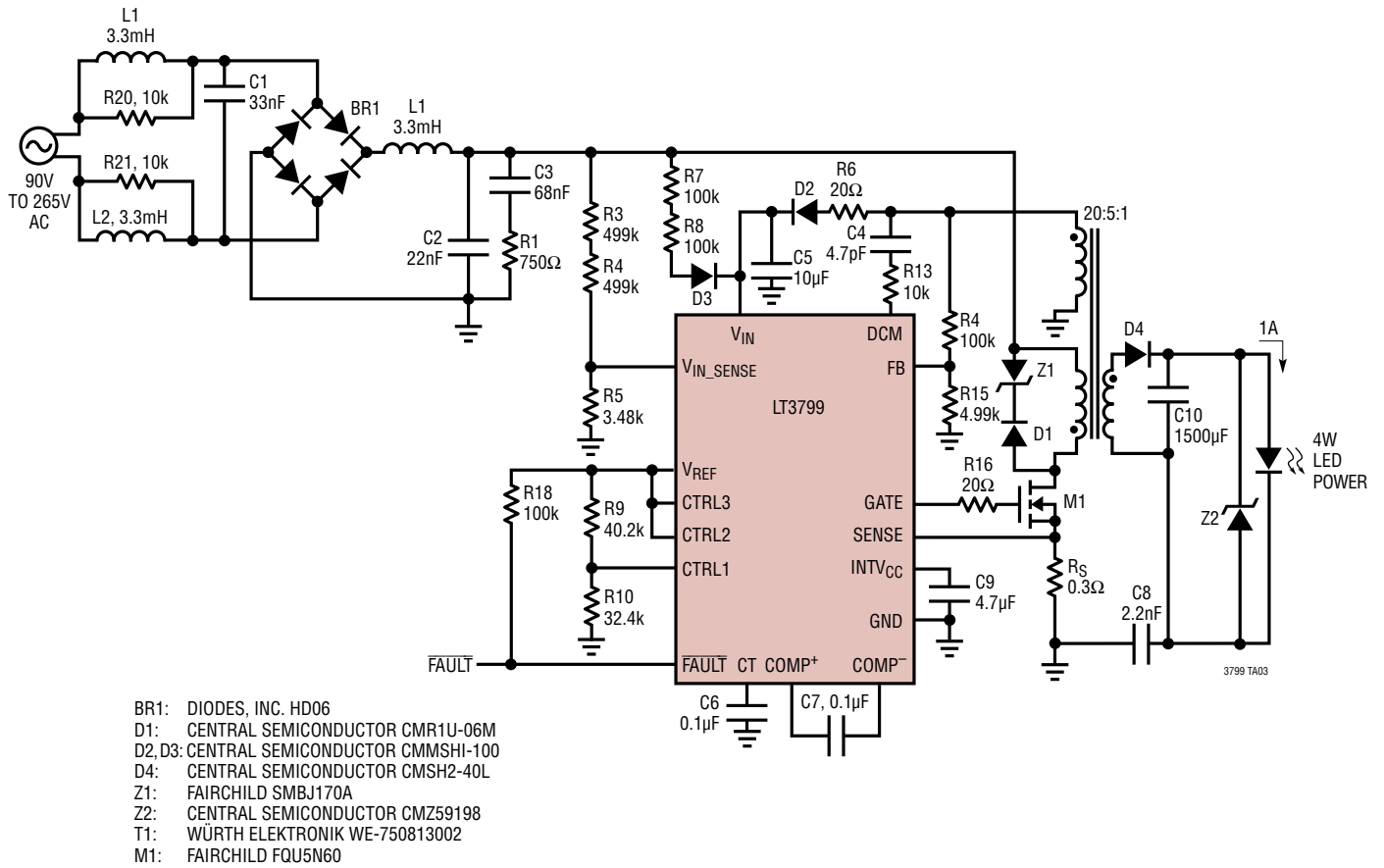

PACKAGE DESCRIPTION

Please refer to <http://www.linear.com/designtools/packaging/> for the most recent package drawings.

MSE Package 16-Lead Plastic MSOP, Exposed Die Pad (Reference LTC DWG # 05-08-1667 Rev D)

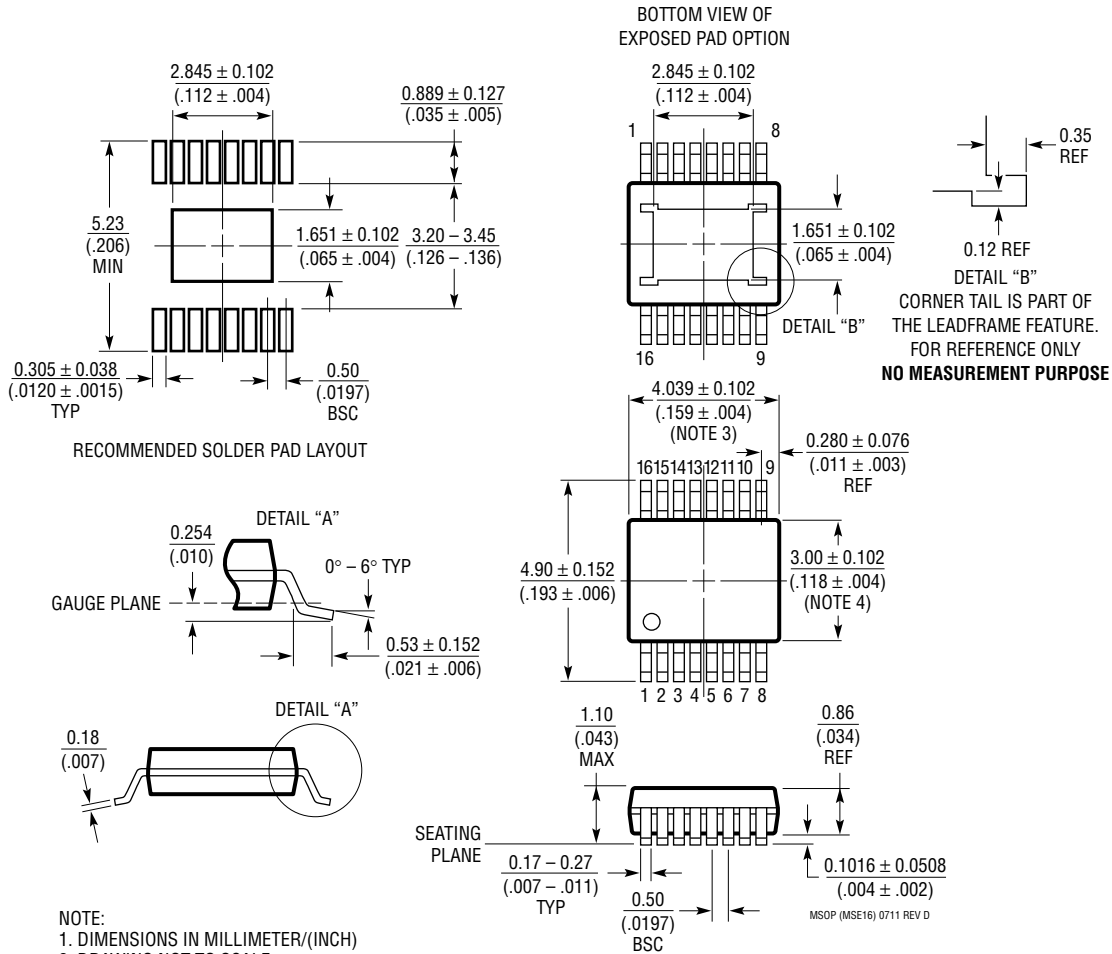

REVISION HISTORY

REV	DATE	DESCRIPTION	PAGE NUMBER
A	01/12	Added "Maximum" to SENSE Current Limit Threshold parameter; Updated Conditions and Typ and Max values for Dropout ($V_{IN} - INTV_{CC}$) parameter; Changed Current Limit Typ value to 15.	3
		Corrected Y-axis labels for G21, G22 and G23.	6
		Reordered Pin Functions in numerical order.	7
		Removed section title "Setting Control Voltages for LED Over Temperature and Brownout Conditions".	12
B	02/16	Amended Current Limit Below Undervoltage Threshold	3

TYPICAL APPLICATION

Universal Input TRIAC Dimmable 14W LED Driver

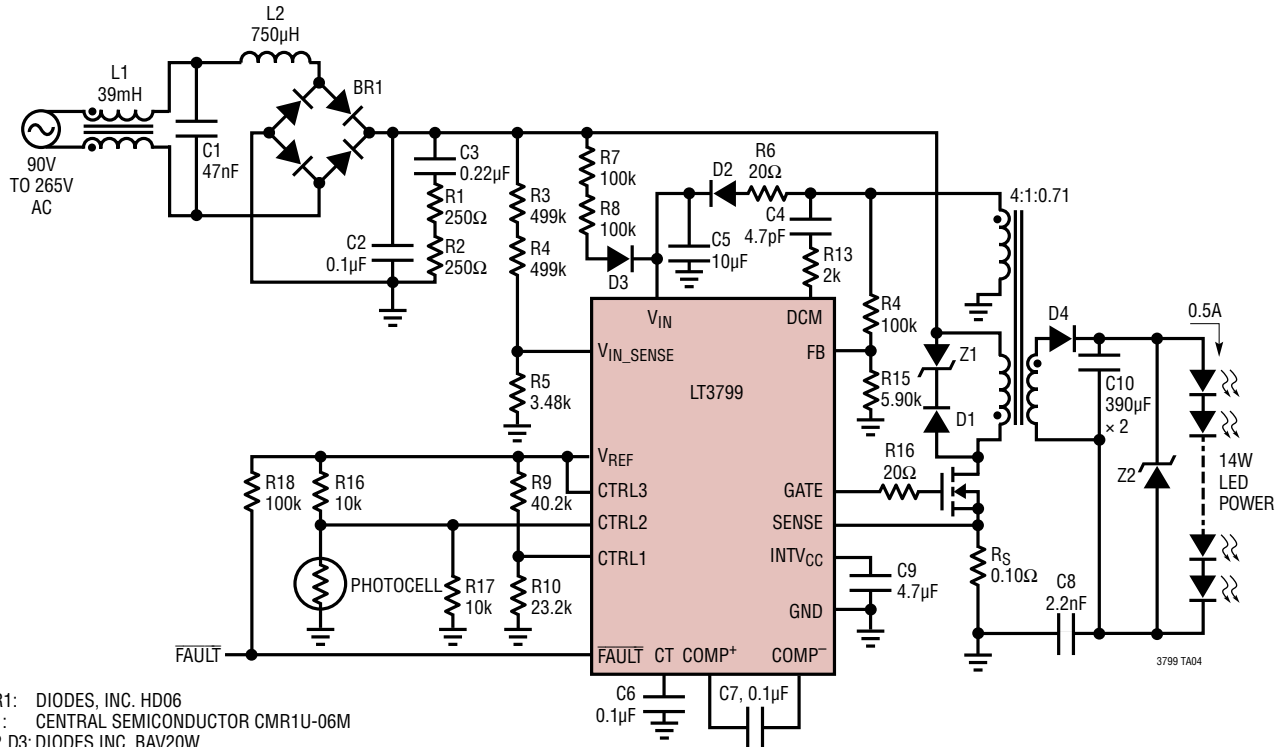

- BR1: DIODES, INC. HD06
- D1: CENTRAL SEMICONDUCTOR CMR1U-06M
- D2, D3: DIODES INC. BAV20W
- D4: DIODES INC. DFSL1150
- Z1: FAIRCHILD SMBJ170A
- Z2: CENTRAL SEMICONDUCTOR CMZ5938B
- T1: WÜRTH ELEKTRONIK WE750813144
- M1: ST MICRO STD12N65M5

RELATED PARTS

PART NUMBER	DESCRIPTION	COMMENTS
LT3755/ LT3755-1/ LT3755-2	High Side 60V, 1MHz LED Controller with 3000:1 True Color PWM™ Dimming	V _{IN} : 4.5V to 40V, V _{OUT(MAX)} = 60V, Dimming: 3000:1 True Color PWM, I _{SD} < 1µA, 3mm × 3mm QFN-16 and MSOP-16E Packages
LT3756/ LT3756-1/ LT3756-2	High Side 100V, 1MHz LED Controller with 3000:1 True Color PWM Dimming	V _{IN} : 6V to 100V, V _{OUT(MAX)} = 100V, Dimming: 3000:1 True Color PWM, I _{SD} < 1µA, 3mm × 3mm QFN-16 and MSOP-16E Packages
LT3743	Synchronous Step-Down 20A LED Driver with Three-State LED Current Control	V _{IN} : 5.5V to 36V, Dimming: 10000:1 True Color PWM, I _{SD} < 1µA, 5mm × 8mm QFN-52 Package
LT3518	2.3A, 2.5MHz High Current LED Driver with 3000:1 Dimming	V _{IN} : 3V to 30V, Dimming: 3000:1 True Color PWM, I _{SD} < 1µA, 4mm × 4mm QFN-16 Package
LT3517	1.3A, 2.5MHz High Current LED Driver with 3000:1 Dimming	V _{IN} : 3V to 30V, Dimming: 3000:1 True Color PWM, I _{SD} < 1µA, 4mm × 4mm QFN-16 Package
LT3741	High Power, Constant-Current, Constant-Voltage Synchronous Step-Down Controller	V _{IN} : 6V to 36V, Average Current Mode Control, I _{SD} < 1µA, 4mm × 4mm QFN-20 and TSSOP-20E Packages

Mouser Electronics

Authorized Distributor

Click to View Pricing, Inventory, Delivery & Lifecycle Information:

[Analog Devices Inc.:](#)

[LT3799EMSE#TRPBF](#) [LT3799IMSE#PBF](#) [LT3799IMSE#TRPBF](#) [LT3799EMSE#PBF](#)