

Fixed 1.5V, 4.6A and 5A Low Dropout, Fast Response GTL+ Regulators

FEATURES

- Fast Transient Response
- Guaranteed Dropout Voltage at Multiple Currents
- Load Regulation: 0.05% Typ
- Trimmed Current Limit
- On-Chip Thermal Limiting

APPLICATIONS

- GTL+ Power Supply
- Low Voltage Logic Supplies
- Battery-Powered Circuitry

DESCRIPTION

The LT[®]1585-1.5/LT1585A-1.5 are low dropout, 3-terminal regulators with 4.6A and 5A output current capability respectively, and a fixed 1.5V output voltage. The designs are optimized for low voltage applications where transient response and minimum input voltage are critical. Similar to the LT1084, they have lower dropout and faster transient response. These improvements make them ideal for low voltage microprocessor applications, especially as the regulator in an Intel processor GTL+ supply.

Current limit is trimmed to ensure specified output current and controlled short-circuit current. On-chip thermal limiting provides protection against any combination of overload that creates excessive junction temperatures.

The LT1585-1.5/LT1585A-1.5 are available in the through-hole 3-pin TO-220 power package and 3-pin plastic DD.

LT, LTC and LT are registered trademarks of Linear Technology Corporation.

TYPICAL APPLICATION

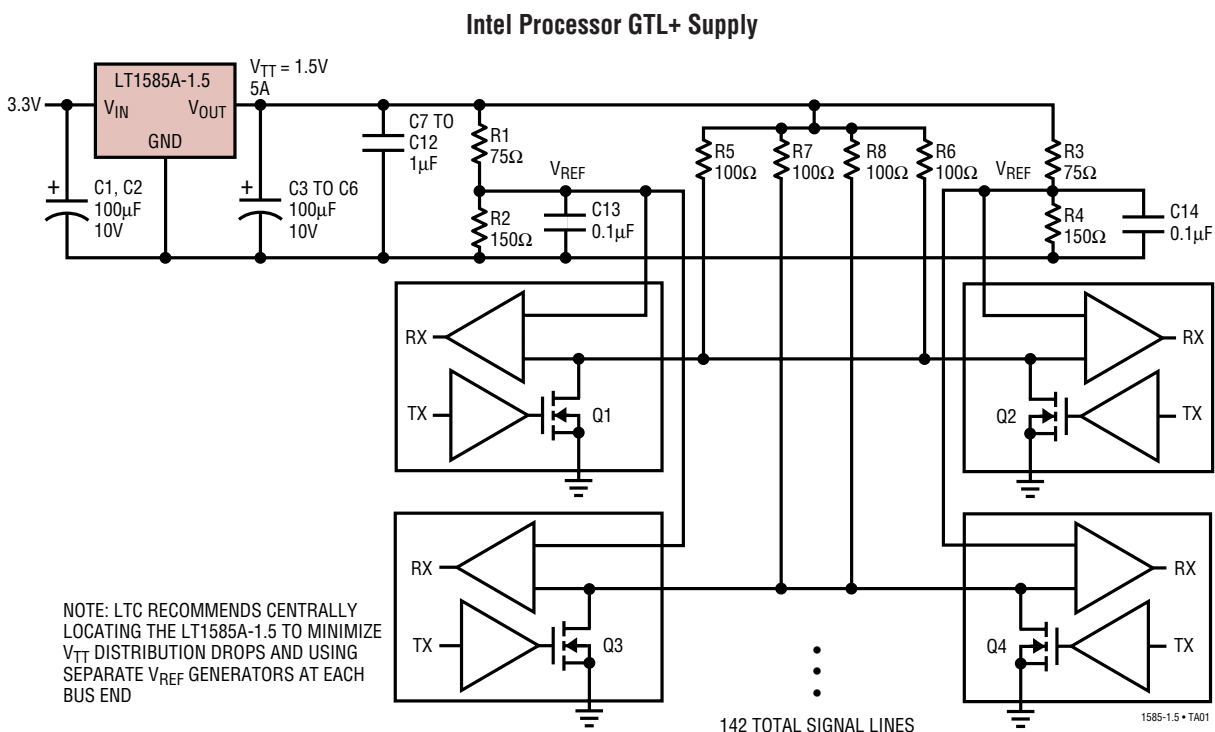

LT1585-1.5/LT1585A-1.5

ABSOLUTE MAXIMUM RATINGS (Note 1)

V_{IN}	7V	Storage Temperature Range	-65°C to 150°C
Operating Junction Temperature Range		Lead Temperature (Soldering, 10 sec)	300°C
Control Section	0°C to 125°C		
Power Transistor	0°C to 150°C		

PRECONDITIONING

100% Thermal Limit Functional Test

PACKAGE/ORDER INFORMATION

<p>FRONT VIEW</p> <p>TAB IS OUTPUT</p> <p>3 V_{IN}</p> <p>2 V_{OUT}</p> <p>1 GND</p> <p>M PACKAGE 3-LEAD PLASTIC DD $\theta_{JA} = 30^{\circ}\text{C/W}^*$</p>	<p>*WITH PACKAGE SOLDERED TO 0.5 SQUARE INCH COPPER AREA OVER BACKSIDE GROUND PLANE OR INTERNAL POWER PLANE. θ_{JA} CAN VARY FROM 20°C/W TO >40°C/W WITH OTHER MOUNTING TECHNIQUES</p>	ORDER PART NUMBER	<p>FRONT VIEW</p> <p>TAB IS OUTPUT</p> <p>3 V_{IN}</p> <p>2 V_{OUT}</p> <p>1 GND</p> <p>T PACKAGE 3-LEAD PLASTIC TO-220 $\theta_{JA} = 50^{\circ}\text{C/W}$</p>	ORDER PART NUMBER
		<p>LT1585CM-1.5</p> <p>LT1585ACM-1.5</p>		<p>LT1585CT-1.5</p> <p>LT1585ACT-1.5</p>

Consult factory for Industrial and Military grade parts.

ELECTRICAL CHARACTERISTICS

The ● denotes specifications which apply over the specified operating temperature range, otherwise specifications are at $T_A = 25^{\circ}\text{C}$.

PARAMETER	CONDITIONS	MIN	TYP	MAX	UNITS
Output Voltage (Note 4)	$V_{IN} = 5\text{V}$, $T_J = 25^{\circ}\text{C}$, $I_{OUT} = 0\text{mA}$	1.485 (-1%)	1.5	1.515 (+1%)	V
	$3\text{V} \leq V_{IN} \leq 7\text{V}$, $0\text{mA} \leq I_{OUT} \leq I_{FULL\ LOAD}$	1.470 (-2%)	1.5	1.530 (+2%)	V
Line Regulation (Notes 2, 3)	$3\text{V} \leq V_{IN} \leq 7\text{V}$, $I_{OUT} = 0\text{mA}$		0.005	0.2	%
Load Regulation (Notes 2, 3, 4)	$V_{IN} = 5\text{V}$, $T_J = 25^{\circ}\text{C}$, $0\text{mA} \leq I_{OUT} \leq I_{FULL\ LOAD}$		0.05	0.3	%
			0.05	0.5	%
Dropout Voltage (Note 4)	$\Delta V_{OUT} = 1\%$, $I_{OUT} = I_{FULL\ LOAD}$		1.200	1.400	V
Current Limit	LT1585-1.5, $(V_{IN} - V_{OUT}) = 5.5\text{V}$	4.60	5.25		A
	LT1585A-1.5, $(V_{IN} - V_{OUT}) = 5.5\text{V}$	5.00	6.00		A
Quiescent Current	$V_{IN} = 5\text{V}$		7	13	mA
Ripple Rejection (Note 4)	$f = 120\text{Hz}$, $C_{OUT} = 25\mu\text{F}$ Tant., $V_{IN} = 4.5\text{V}$, $I_{OUT} = I_{FULL\ LOAD}$	60	72		dB
Thermal Regulation	$T_A = 25^{\circ}\text{C}$, 30ms Pulse		0.004	0.02	%/W
Temperature Stability			0.5		%
Long-Term Stability	$T_A = 125^{\circ}\text{C}$, 1000 Hrs.		0.03	1.0	%
RMS Output Noise (% of V_{OUT})	$T_A = 25^{\circ}\text{C}$, $10\text{Hz} \leq f \leq 10\text{kHz}$		0.003		%
Thermal Resistance Junction to Case	T Package: Control Circuitry/Power Transistor			0.7/3.0	$^{\circ}\text{C/W}$
	M Package: Control Circuitry/Power Transistor			0.7/3.0	$^{\circ}\text{C/W}$

Note 1: Absolute Maximum Ratings are those values beyond which the life of the device may be impaired.

Note 2: See thermal regulation specifications for changes in output voltage due to heating effects. Load and line regulation are measured at a constant junction temperature by low duty cycle pulse testing.

Note 3: Line and load regulation are guaranteed up to the maximum power dissipation (25W for the LT1585-1.5 in T package and 27.5W for

the LT1585A-1.5). Power dissipation is determined by input/output differential and the output current. Guaranteed maximum output power will not be available over the full input/output voltage range.

Note 4: $I_{FULL\ LOAD}$ is defined as the maximum value of output load current as a function of input-to-output voltage. $I_{FULL\ LOAD}$ is equal to 4.6A for the LT1585-1.5 and 5A for the LT1585A-1.5. The LT1585-1.5/LT1585A-1.5 have constant current limit with changes in input-to-output voltage.

TYPICAL PERFORMANCE CHARACTERISTICS

LT1585A-1.5 Dropout Voltage vs Output Current

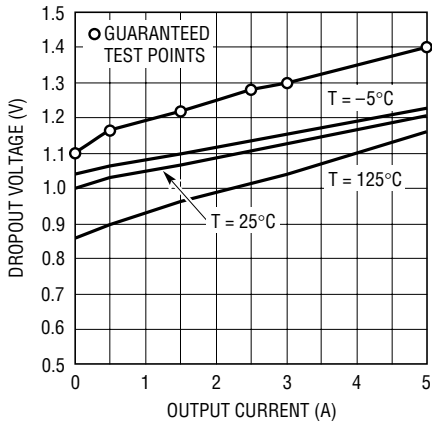

1585-1.5 G01

LT1585A-1.5 Short-Circuit Current vs Temperature

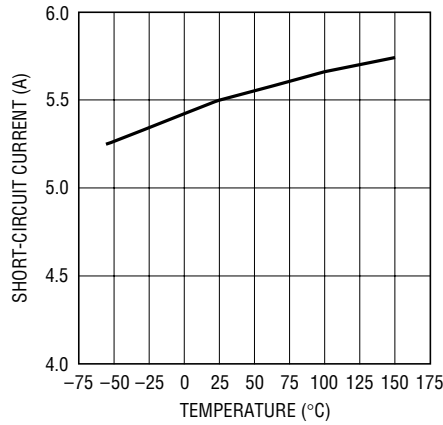

1585-1.5 G02

Load Regulation vs Temperature

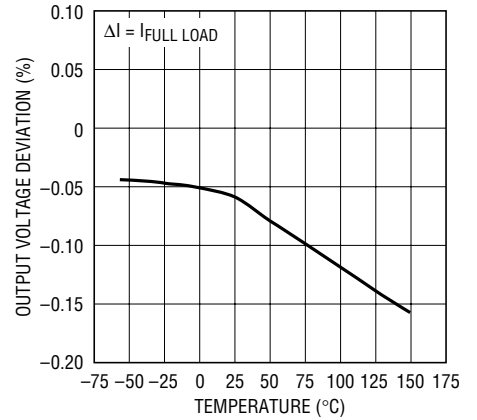

1585-1.5 G03

Output Voltage vs Temperature

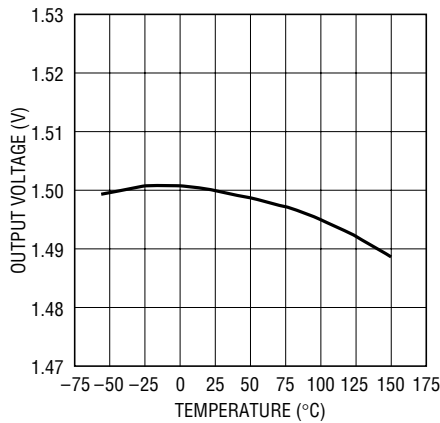

1585-1.5 G04

Quiescent Current vs Temperature

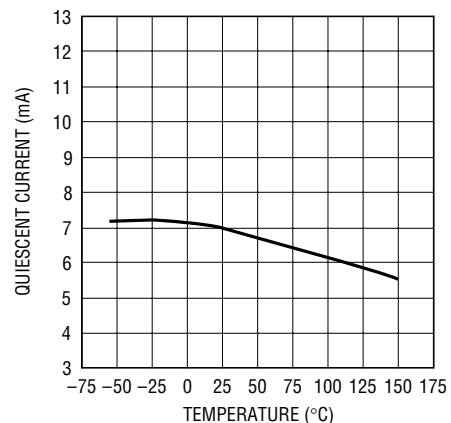

1585-1.5 G05

Ripple Rejection vs Frequency

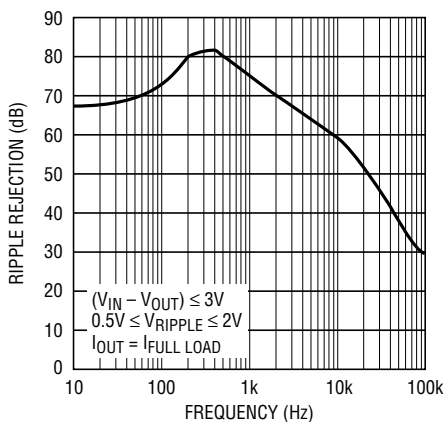

1585-1.5 G06

Maximum Power Dissipation*

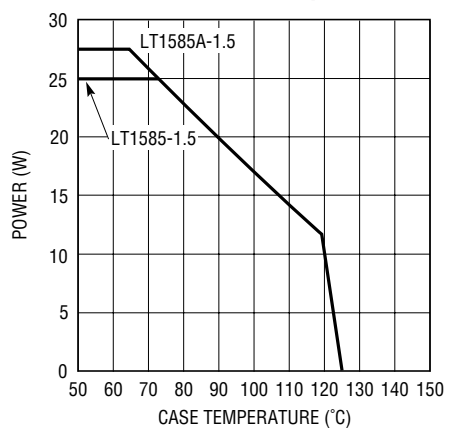

1585-1.5 G07

*AS LIMITED BY MAXIMUM JUNCTION TEMPERATURE

SIMPLIFIED SCHEMATIC

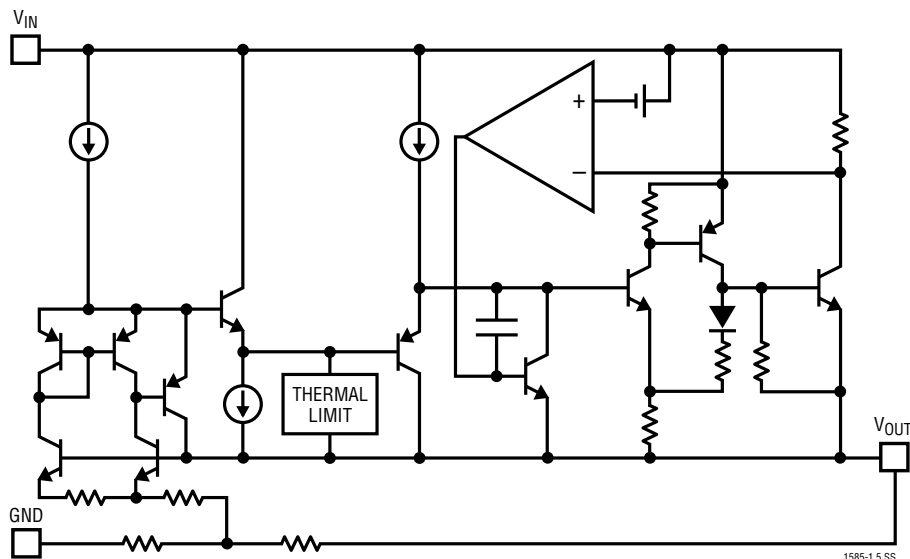

APPLICATIONS INFORMATION

General

The LT1585-1.5/LT1585A-1.5 3-terminal regulators are easy to use and have all the protection features expected in high performance linear regulators. The devices are short-circuit protected, safe-area protected and provide thermal shutdown to turn off the regulators if the junction temperature exceeds about 150°C.

The ICs are pin compatible with the LT1083/LT1084/LT1085 family of linear regulators but offer lower dropout voltage and faster transient response. The trade-off for this improved performance is a 7V maximum supply voltage. Similar to the LT1083/LT1084/LT1085 family, the LT1585-1.5/LT1585A-1.5 regulators require an output capacitor for stability. However, the improved frequency compensation permits the use of capacitors with much lower ESR while still maintaining stability. This is critical in addressing the needs of modern low voltage, high speed microprocessors.

Current generation microprocessors and their associated circuitry cycle load current from almost zero to several amps in tens of nanoseconds. Output voltage tolerances are tighter and include transient response as part of the specification. The LT1585-1.5/LT1585A-1.5 are specifically designed to meet the fast current load step require-

ments of these applications and save total cost by needing less output capacitance in order to maintain regulation.

Stability

The circuit design in the LT1585-1.5/LT1585A-1.5 requires the use of an output capacitor as part of the frequency compensation. For all operating conditions, the addition of a 22 μ F solid tantalum or a 100 μ F aluminum electrolytic on the output ensures stability. Normally, the LT1585-1.5/LT1585A-1.5 can use smaller value capacitors. Many different types of capacitors are available and have widely varying characteristics. These capacitors differ in capacitor tolerance (sometimes ranging up to $\pm 100\%$), equivalent series resistance, equivalent series inductance and capacitance temperature coefficient. The LT1585-1.5/LT1585A-1.5 frequency compensation optimizes frequency response with low ESR capacitors. In general, use capacitors with an ESR of less than 1 Ω .

Normally, capacitor values on the order of several hundred microfarads are used on the output of the regulators to ensure good transient response with heavy load current changes. Output capacitance can increase without limit and larger values of output capacitance further improve the

APPLICATIONS INFORMATION

stability and transient response of the LT1585-1.5/LT1585A-1.5.

Large load current changes are exactly the situation presented by modern microprocessors and their peripheral circuitry. The load current step contains higher order frequency components that the output decoupling network must handle until the regulator throttles to the load current level. Capacitors are not ideal elements and contain parasitic resistance and inductance. These parasitic elements dominate the change in output voltage at the beginning of a transient load step change. The ESR of the output capacitors produces an instantaneous step in output voltage [$\Delta V = \Delta I(\text{ESR})$]. The ESL of the output capacitors produces a droop proportional to the rate of change of output current [$V = L(\Delta I/\Delta t)$]. The output capacitance produces a change in output voltage proportional to the time until the regulator can respond [$\Delta V = \Delta t(\Delta I/C)$]. These transient effects are illustrated in Figure 1.

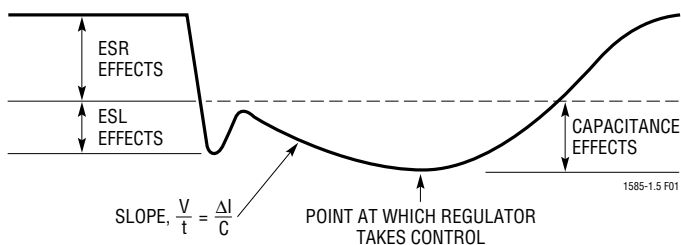

Figure 1

The use of capacitors with low ESR, low ESL and good high frequency characteristics is critical in meeting the output voltage tolerances of these high speed microprocessor applications. These requirements dictate a combination of high quality surface mount tantalum capacitors and ceramic capacitors. The location of the decoupling network is critical to transient response performance. Place the decoupling network as close as possible to the microprocessor control circuitry because a trace run from the decoupling capacitors to the actual circuitry is inductive. In addition, use large power and ground plane areas to minimize distribution drops.

A possible stability problem that occurs in monolithic linear regulators is current limit oscillations. The LT1585-1.5/LT1585A-1.5 essentially have a flat current limit over the

range of input supply voltage. The lower current limiting and 7V maximum supply voltage rating for this device permit this characteristic. Current limit oscillations are typically nonexistent unless the input and output decoupling capacitors for the regulators are mounted several inches from the terminals.

Protection Diodes

In normal operation, the LT1585-1.5/LT1585A-1.5 do not require any protection diodes. Older 3-terminal regulators require protection diodes between the output pin and the input pin to prevent die overstress.

A protection diode between the input and output pins is usually not needed. An internal diode between the input and output pins on the LT1585-1.5/LT1585A-1.5 can handle microsecond surge currents of 50A to 100A. Even with large value output capacitors it is difficult to obtain those values of surge currents in normal operation. Only with large values of output capacitance, such as 1000 μ F to 5000 μ F, and with the input pin instantaneously shorted to ground can damage occur. A crowbar circuit at the input of the LT1585-1.5/LT1585A-1.5 can generate those levels of current and a diode from output to input is then recommended. This is shown in Figure 2. Usually, normal power supply cycling or system "hot plugging and unplugging" will not generate current large enough to do any damage.

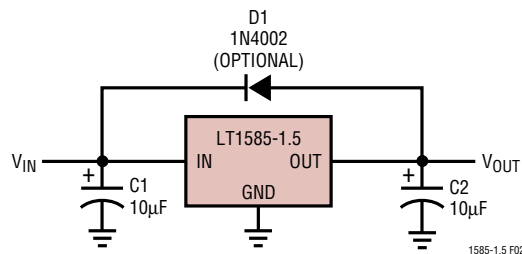

Figure 2

Ripple Rejection

The typical curve for ripple rejection reflects values for the LT1585-1.5/LT1585A-1.5 as a function of frequency. In applications that require improved ripple rejection, use the adjustable LT1585/LT1585A. A bypass capacitor from the adjust pin to ground reduces the output ripple by the ratio of $V_{\text{OUT}}/1.25\text{V}$.

APPLICATIONS INFORMATION

Load Regulation

It is not possible to provide true remote load sensing because the LT1585-1.5/LT1585A-1.5 are 3-terminal devices. Load regulation is limited by the resistance of the wire connecting the regulators to the load. Load regulation per the data sheet specification is measured at the bottom of the package.

For fixed voltage devices, negative side sensing is a true Kelvin connection with the GND pin of the device returned to the negative side of the load. This is illustrated in Figure 3.

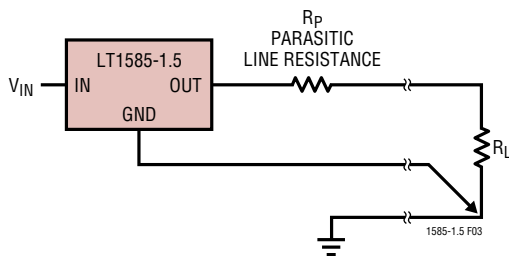

Figure 3. Connection for Best Load Regulation

Thermal Considerations

The LT1585-1.5/LT1585A-1.5 protect the device under overload conditions with internal power and thermal limiting circuitry. However, for normal continuous load conditions, do not exceed maximum junction temperature ratings. It is important to consider all sources of thermal resistance from junction-to-ambient. These sources include the junction-to-case resistance, the case-to-heat sink interface resistance, and the heat sink resistance. Thermal resistance specifications have been developed to more accurately reflect device temperature and ensure safe operating temperatures. The electrical characteristics section provides a separate thermal resistance and maximum junction temperature for both the control circuitry and the power transistor. Older regulators with a single junction-to-case thermal resistance specification, use an average of the two values provided here and allow excessive junction temperatures under certain conditions of ambient temperature and heat sink resistance. Calculate the maximum junction temperature for both sections to ensure that both thermal limits are met.

Junction-to-case thermal resistance is specified from the IC junction to the bottom of the case directly below the die. This is the lowest resistance path for heat flow. Proper mounting ensures the best thermal flow from this area of the package to the heat sink. Linear Technology strongly recommends thermal compound at the case-to-heat sink interface. Use a thermally conductive spacer if the case of the device must be electrically isolated and include its contribution to the total thermal resistance. Please consult “Mounting Considerations for Power Semiconductors” *1990 Linear Applications Handbook, Volume I*, Pages RR3-1 to RR3-20. The output connects to the case of the device in the LT1585-1.5/LT1585A-1.5.

For example, using an LT1585ACT-1.5 (TO-220, commercial) and assuming:

$$V_{IN} (\text{Max Continuous}) = 3.465\text{V} (3.3\text{V} + 5\%), V_{OUT} = 1.5\text{V}$$

$$I_{OUT} = 5\text{A}$$

$$T_A = 70^\circ\text{C}, \theta_{\text{HEAT SINK}} = 3^\circ\text{C/W}$$

$$\theta_{\text{CASE-TO-HEAT SINK}} = 1^\circ\text{C/W} (\text{with Thermal Compound})$$

Power dissipation under these conditions is equal to:

$$P_D = (V_{IN} - V_{OUT})(I_{OUT}) = (3.465 - 1.5)(5\text{A}) = 9.825\text{W}$$

Junction temperature will be equal to:

$$T_J = T_A + P_D(\theta_{\text{HEAT SINK}} + \theta_{\text{CASE-TO-HEAT SINK}} + \theta_{JC})$$

For the Control Section:

$$T_J = 70^\circ\text{C} + 9.825\text{W} (3^\circ\text{C/W} + 1^\circ\text{C/W} + 0.7^\circ\text{C/W}) = 116.2^\circ\text{C}$$

$$116.2^\circ\text{C} < 125^\circ\text{C} = T_{J\text{MAX}} (\text{Control Section Commercial Range})$$

For the Power Transistor:

$$T_J = 70^\circ\text{C} + 9.825\text{W} (3^\circ\text{C/W} + 1^\circ\text{C/W} + 3^\circ\text{C/W}) = 138.8^\circ\text{C}$$

$$138.8^\circ\text{C} < 150^\circ\text{C} = T_{J\text{MAX}} (\text{Power Transistor Commercial Range})$$

In both cases the junction temperature is below the maximum rating for the respective sections, ensuring reliable operation.

PACKAGE DESCRIPTION Dimensions in inches (millimeters) unless otherwise noted.

M Package
3-Lead Plastic DD Pak
 (LTC DWG # 05-08-1460)

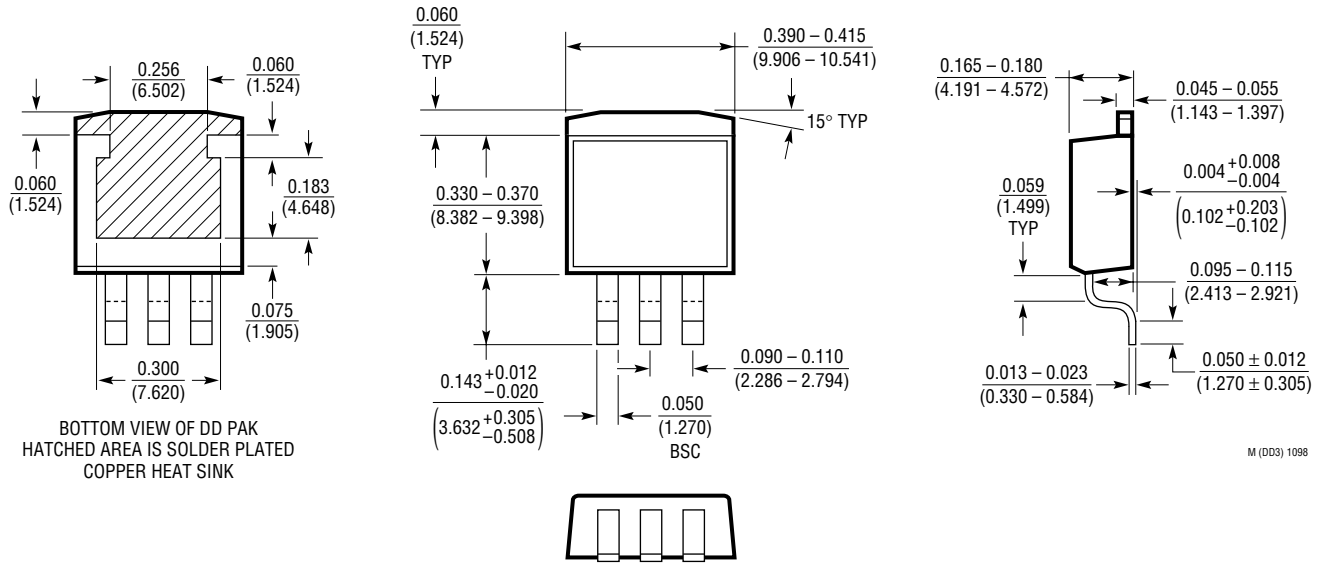

T Package
3-Lead Plastic TO-220
 (LTC DWG # 05-08-1420)

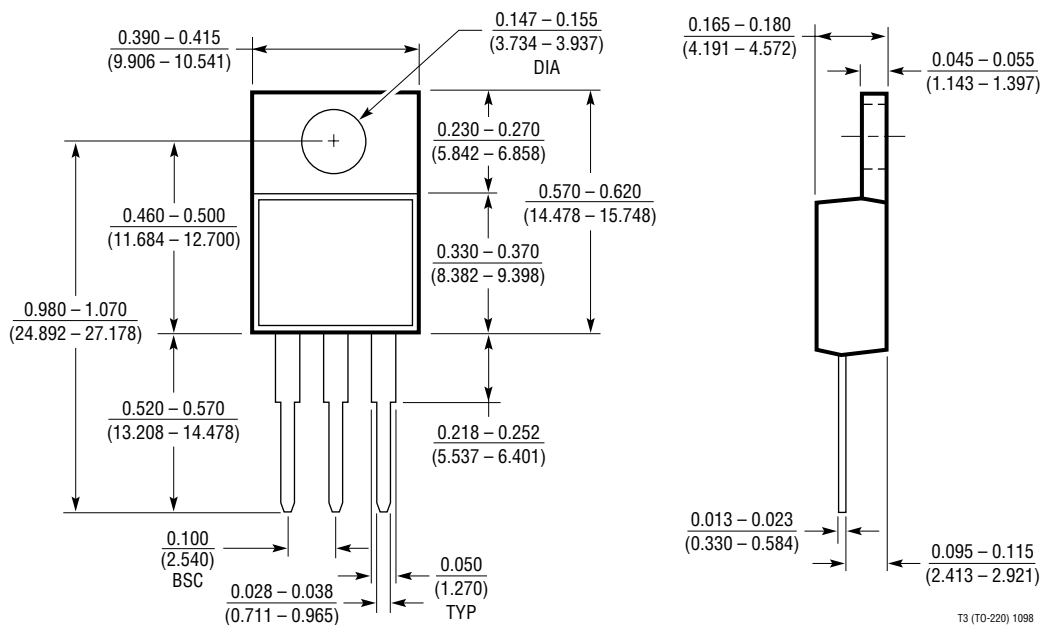

RELATED PARTS

PART NUMBER	DESCRIPTION	COMMENTS
LTC®1392	Micropower Temperature, Power Supply and Differential Voltage Monitor	Micropower Data Acquisition to Monitor System
LTC1530	High Power Step-Down Synchronous DC/DC Controller in SO-8	Synchronous Operation Up to 15A, Fixed or Adj Outputs
LT1528	Low Dropout 3A Linear Regulator	0.6V Dropout for 5V to 4V Regulation
LT1573	Low Dropout Regulator Driver	Drives Low Cost PNP, Fast Transient Response
LT1575	Ultrafast™ Transient Response Low Dropout Regulator Driver	Drives N-Channel MOSFET Up to 10A, SO-8
LT1580	Very Low Dropout 7A Linear Regulator	0.54V Dropout at 7A, Fixed 2.5V _{OUT} or Adjustable

Ultrafast is a trademark of Linear Technology Corporation.

Mouser Electronics

Authorized Distributor

Click to View Pricing, Inventory, Delivery & Lifecycle Information:

Analog Devices Inc.:

[LT1585CT-1.5#PBF](#) [LT1585CM-1.5#PBF](#) [LT1585ACM-1.5#TR](#) [LT1585ACM-1.5](#) [LT1585ACM-1.5#TRPBF](#)
[LT1585CM-1.5#TR](#) [LT1585CM-1.5](#) [LT1585ACT-1.5](#) [LT1585ACM-1.5#PBF](#) [LT1585CT-1.5](#) [LT1585ACT-1.5#PBF](#)
[LT1585CM-1.5#TRPBF](#)