



PHB Series Short Stroke Pushbutton Switches

Pushbutton
A



Features/Benefits

- Momentary or latching action
- Low cost, reliable contact design
- 2 & 4 pole configurations
- Sealed contacts
- Optional buttons
- RoHS compliant

Typical Applications

- Computers and peripherals
- Instrumentation and measurement equipment
- Non-power, on-off switch applications

Specifications

RATING: 1 A @ 15 V DC
 DIELECTRIC STRENGTH (50 Hz/1 min.): 500 V DC between terminals or between terminals and frame for 1 minute
 OPERATING LIFE: 10,000 cycles at rated load
 CONTACT RESISTANCE: 20 m Ω ohms initial
 INSULATION RESISTANCE: 100 M Ω ohms
 TOTAL TRAVEL/LATCHING TRAVEL: 2.5mm (\pm 0.5 mm) / 1.5mm (\pm 0.5 mm) to latch EE option (push-push)
 OPERATING FORCE:
 2U option: 170 grams \pm 100 grams (1.67 \pm 0.98N)
 4U option: 230 grams \pm 100 grams (2.26 \pm 0.98N)
 OPERATING TEMPERATURE: -10°C to 60°C
 BOUNCE TIME: \leq 10 ms
 SEALING: Sealed contacts.
 PACKAGING: Switches; PHB2 models: 84 pcs per tray; PHB4 models 72 pcs per tray
 Optional Caps; Bulk bag - 100 caps per bag

Materials

FIXED TERMINAL: Brass, silver plated
 MOVABLE CONTACT: Phosphor bronze, silver plated
 COVER: PA 66 Black
 COVER TO BASE RETAINING CLIP: POM
 ACTUATOR: POM
 RETURN SPRING: Stainless steel
 SPRING RETAINING RING: Steel, nickel plate
 BASE: Phenolic resin
 TERMINAL SEAL: Epoxy.

NOTE: Specifications and materials listed above are for switches with standard options. For information on specific and custom switches, consult Customer Service Center.

Build-A-Switch

To order, simply select desired option from each category and place in the appropriate box. For additional options not shown in catalog, consult Customer Service Center.

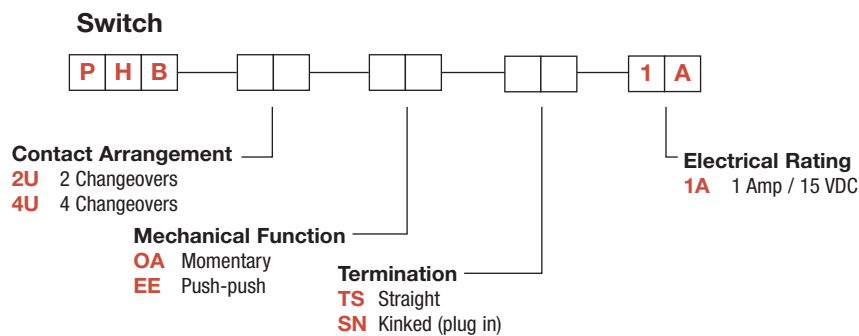

Caps (order separately)



INDEXED	COLOR	RECTANGULAR	COLOR	ROUND	COLOR	SQUARE	COLOR
G001A	BLACK	G002A	BLACK	G003A	BLACK	G004A	BLACK
G001G	GRAY	G002G	GRAY	G003G	GRAY	G004G	GRAY
G001I	IVORY	G002I	IVORY	G003I	IVORY	G004I	IVORY
G001R	RED	G002R	RED	G003R	RED	G004R	RED



Dimensions are shown: Inches (mm)
 Specifications and dimensions subject to change

PHB Series Short Stroke Pushbutton Switches



A

Pushbutton

TERMINATION

TS STRAIGHT

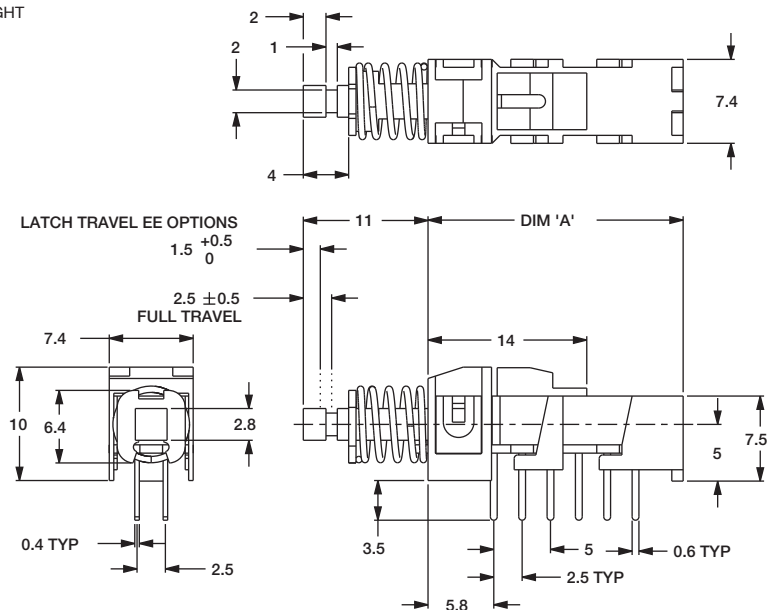

SN KINKED (PLUG IN)

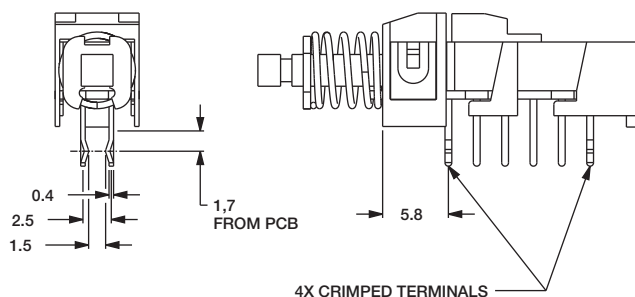

POLES	MODEL NO.	DIM 'A'	ACTION
4	PHB4UEE1A	22,5	PUSH/PUSH
	PHB4U0A1A	22,5	MOMENTARY
2	PHB2UEE1A	15,0	PUSH/PUSH
	PHB2U0A1A	15,0	MOMENTARY

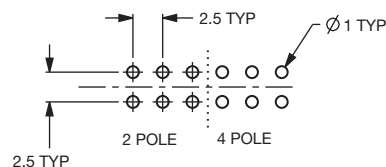
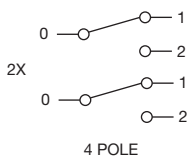
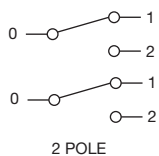

Dimensions are shown: mm
Specifications and dimensions subject to change



PHB Series Short Stroke Pushbutton Switches

CAPS

A

Pushbutton

Indexed

- G001A** Black
- G001G** Gray
- G001I** Ivory
- G001R** Red

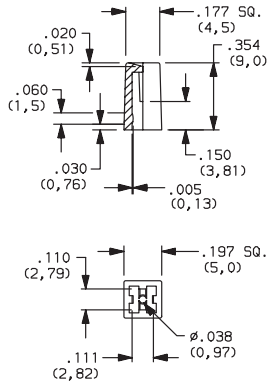
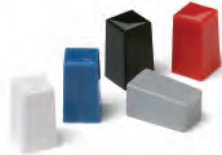

Rectangular

- G002A** Black
- G002G** Gray
- G002I** Ivory
- G002R** Red

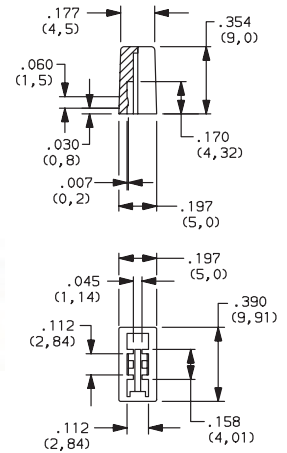

Round

- G003A** Black
- G003G** Gray
- G003I** Ivory
- G003R** Red

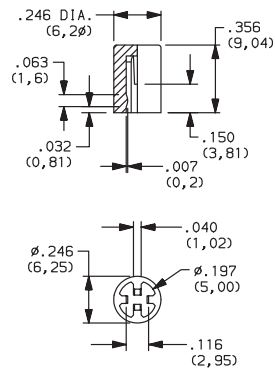

Square

- G004A** Black
- G004G** Gray
- G004I** Ivory
- G004R** Red

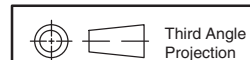
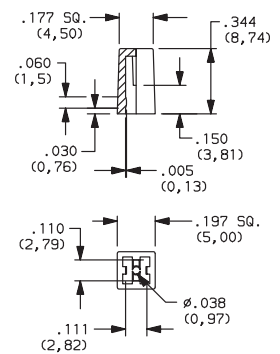
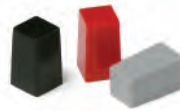

Dimensions are shown: Inches (mm)
Specifications and dimensions subject to change

Mouser Electronics

Authorized Distributor

Click to View Pricing, Inventory, Delivery & Lifecycle Information:

C&K Components:

[PHA4UEE](#) [PHA4UOA](#) [PHA6UEE](#) [PHA6UOA](#) [PHA2UOA](#) [PHA2UEE](#) [G003I](#) [G001I](#) [G002I](#) [G004I](#)