

## Features

- Fast switching
- Automatic reset
- SMB package
- Suitable for industrial lighting environments
- RoHS compliant\*

## Applications

- LED streetlights
- LCD backlighting
- Display lighting
- Intrinsically safe lighting

# LSPxxxxBJR Series LED Shunt Protector

## General Information

Bourns® LSP Series protectors are electronic shunts that provide a current bypass when an LED element in an LED string fails open circuit. This ensures the remaining string of LEDs will continue to function. There are many cases where high reliability of the LED lighting must be maintained, such as LCD backlighting, transport lighting, avionics, intrinsically safe and low maintenance lighting.

The LSP Series is available in surface mount package DO-214AA (SMB) size format.

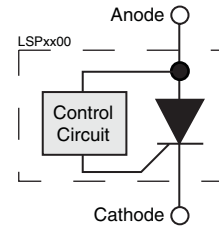

## Absolute Maximum Ratings (@ T<sub>A</sub> = 25 °C Unless Otherwise Noted)

Rating		Symbol	Value	Unit
Repetitive peak off-state voltage	LSP0600	V <sub>DRM</sub>	6	V
	LSP0900		9	
	LSP1300		13	
	LSP1800		18	
Average on-state current (Note 1)		I <sub>T</sub>	1	A
Operating junction temperature		T <sub>J</sub>	-40 to +150	°C
Storage temperature		T <sub>S</sub>	-65 to +150	°C
Lead temperature, soldering (10 s)			260	°C

Notes:

1. Using 75 mm x 75 mm 4-Layer PCB (EIA/JESD51-7).

## Electrical Characteristics (@ T<sub>A</sub> = 25 °C Unless Otherwise Noted)

Parameter	Test Conditions	Min.	Nom.	Max.	Unit
I <sub>DRM</sub> Repetitive peak off-state current	V <sub>D</sub> = V <sub>DRM</sub>			10	μA
V <sub>(BO)</sub> Breakover voltage	dv/dt = 750 V/ms, R <sub>SOURCE</sub> = 300	LSP0600	6	16	V
		LSP0900	9	18	
		LSP1300	13	26	
		LSP1800	18	33	
I <sub>H</sub> Holding current	I <sub>T</sub> = 1 A, di/dt = 30 mA/ms	5	30		mA
I <sub>BO</sub> Breakover current	di/dt = 0.8 A/ms			75	mA
V <sub>T</sub> On-state voltage	I <sub>T</sub> = 1 A			1.2	V

## Thermal Characteristics (@ T<sub>A</sub> = 25 °C Unless Otherwise Noted)

Parameter	Test Conditions	Min.	Nom.	Max.	Unit
Junction to free air thermal resistance	EIA/JESD51-3 PCB, I <sub>T</sub> = 350 mA, T <sub>A</sub> = 25 °C		230		°C/W
Junction to free air thermal resistance	EIA/JESD51-7, 75 mm x 75 mm 4-Layer PCB, I <sub>T</sub> = 1.0 A, T <sub>A</sub> = 25 °C		90		°C/W

JANUARY 2011 - REVISED FEBRUARY 2012

\*RoHS Directive 2002/95/EC Jan. 27, 2003 including annex and RoHS Recast 2011/65/EU June 8, 2011.

Specifications are subject to change without notice.

Customers should verify actual device performance in their specific applications.

# LSPxxxxBJR Series LED Shunt Protector



V-I Characteristic

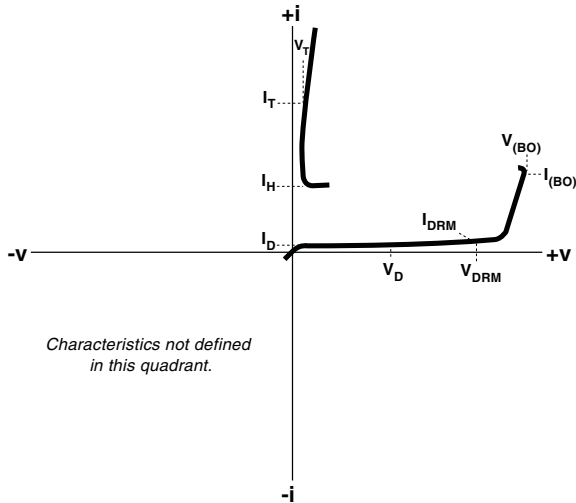

On-state Voltage vs. Junction Temperature

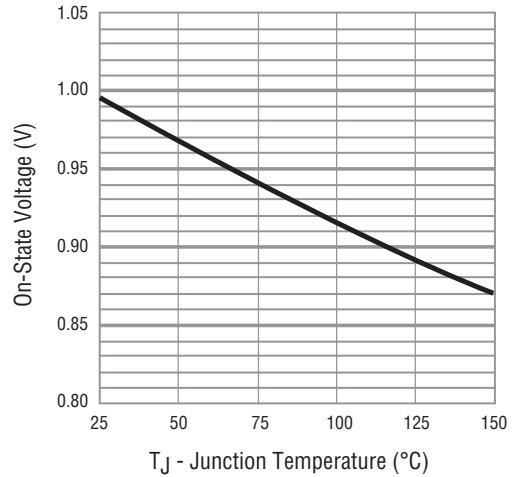

Normalized Breakover Voltage vs. Junction Temperature

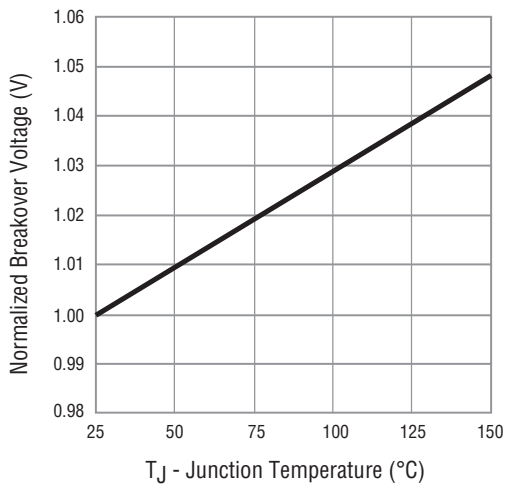

Typical Application

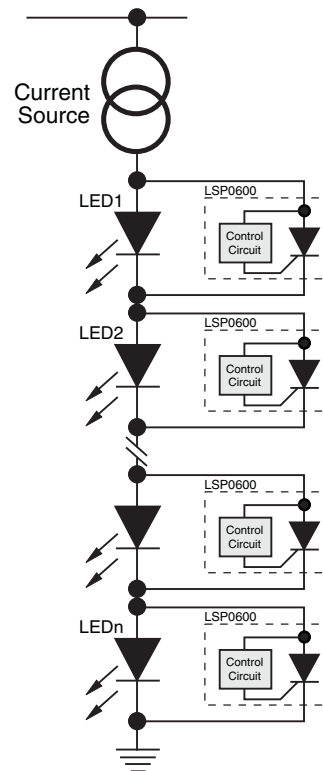

Note: The interaction between the Bourns® LSP device and the power supply for the LED string dictates the power supply architecture. Proper care must be taken in the design of the power supply architecture to ensure that the Bourns® LSP devices operate as intended and the design maintains integrity.

# LSPxxxxBJR Series LED Shunt Protector



## Product Specifications

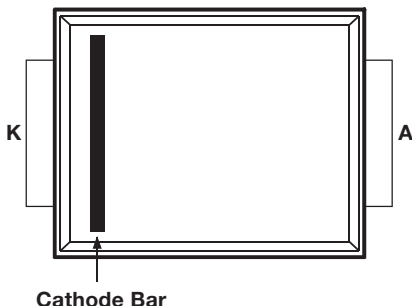

Unit ..... Epoxy molded SMB D0-214AA package  
 Mold Material ..... UL94V-0  
 Terminations ..... 100 % matte tin-plated over copper alloy  
 Unit Weight ..... 102 mg.

## Packaging Specifications

Standard ..... EIA-481-1  
 Tape Width ..... 12 mm (.472 in.)  
 Reel Diameter ..... 330 mm (12.99 in.)  
 Part Alignment ..... Cathode bar adjacent to sprocket hole  
 Quantity per Reel ..... 3,000 pieces

## Typical Part Marking

	Top Side Marking
LSP0600BJR-S .....	LSP060
LSP0900BJR-S .....	LSP090
LSP1300BJR-S .....	LSP130
LSP1800BJR-S .....	LSP180

## How to Order

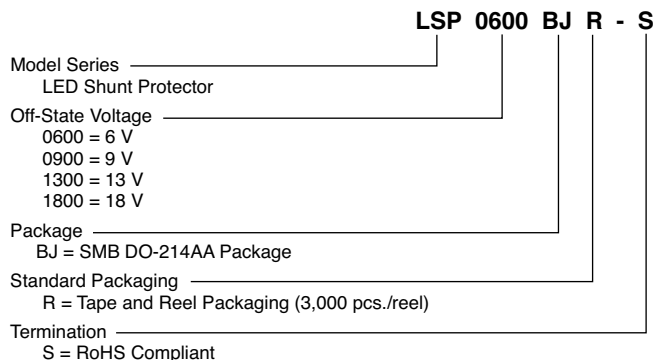

**Asia-Pacific:** Tel: +886-2 2562-4117 • Fax: +886-2 2562-4116  
**Europe:** Tel: +41-41 768 5555 • Fax: +41-41 768 5510  
**The Americas:** Tel: +1-951 781-5500 • Fax: +1-951 781-5700  
[www.bourns.com](http://www.bourns.com)

# Mouser Electronics

Authorized Distributor

Click to View Pricing, Inventory, Delivery & Lifecycle Information:

## Bourns:

[LSP0600AJR-S](#) [LSP0900AJR-S](#) [LSP1300AJR-S](#) [LSP1800AJR-S](#) [LSP0900BJR-S](#) [LSP0600BJR-S](#) [LSP1300BJR-S](#)  
[LSP1800BJR-S](#)