

Features

- Extremely high speed performance
- Blocks high voltages and currents
- Two TBU® protectors in one small package
- Simple, superior circuit protection
- Minimal PCB area
- RoHS compliant*, UL Recognized



Bourns® Model P850-G Series TBU® HSPs are not recommended for POTS applications. This series is suited for applications requiring a dual bidirectional device where 50 ohms of series resistance is acceptable. For new SLIC applications, we recommend that customers evaluate our [TBU-PL Series](#).

P850-G Series Dual TBU® High-Speed Protectors

Transient Blocking Units - TBU® Devices

Bourns® Model P850-G TBU® products are dual high-speed bidirectional protection components, constructed using MOSFET semiconductor technology, designed to protect against faults caused by short circuits, AC power cross, induction and lightning surges.

The TBU® high speed protector, triggering as a function of the MOSFET, blocks surges and provides an effective barrier behind which sensitive electronics are not exposed to large voltages or currents during surge events. The TBU® device is provided in a surface mount DFN package and meets industry standard requirements such as RoHS and Pb Free solder reflow profiles.

Agency Approval

UL recognized component File # E315805.

Industry Standards

| Description | | | Model |
|-------------|--------------------------------|----------------|--------|
| Telcordia | GR-1089 | Port Type 3, 5 | P850-G |
| ITU-T | K.20, K.20E, K.21, K.21E, K.45 | | P850-G |

Absolute Maximum Ratings ($T_{amb} = 25\text{ }^{\circ}\text{C}$)

| Symbol | Parameter | Value | Unit |
|-----------|--|-------------|--------------------|
| V_{imp} | Maximum protection voltage for impulse faults with rise time $\geq 1\text{ }\mu\text{sec}$ | 850 | V |
| V_{rms} | Maximum protection voltage for continuous V_{rms} faults | 425 | V |
| T_{op} | Operating temperature range | -40 to +85 | $^{\circ}\text{C}$ |
| T_{stg} | Storage temperature range | -65 to +150 | $^{\circ}\text{C}$ |

Electrical Characteristics ($T_{amb} = 25\text{ }^{\circ}\text{C}$)

| Symbol | Parameter | Model | Min. | Typ. | Max. | Unit |
|-----------------|---|------------------------------|------|------------|------------|---------------|
| I_{op} | Maximum current through the device that will not cause current blocking | P850-G120-WH P850-G200-WH | | | 100 200 | mA |
| $I_{trigger}$ | Typical current for the device to go from normal operating state to protected state | P850-G120-WH P850-G200-WH | | 150 275 | | mA |
| I_{out} | Maximum current through the device | P850-G120-WH P850-G200-WH | | | 200 400 | mA |
| R_{device} | Series resistance of the TBU® device | | | 50 | 55 | Ω |
| R_{bal} | Line-to-line series resistance difference between two TBU® devices | | | | 2 | Ω |
| t_{block} | Maximum time for the device to go from normal operating state to protected state | | | | 1 | μs |
| $I_{quiescent}$ | Current through the triggered TBU® device with 50 Vdc circuit voltage | | | 0.7 | | mA |
| V_{reset} | Voltage below which the triggered TBU® device will transition to normal operating state | | | 22 | | V |

The P-G series TBU® devices are bidirectional; specifications are valid in both directions.

*RoHS Directive 2002/95/EC Jan. 27, 2003 including annex and RoHS Recast 2011/65/EU June 8, 2011.

Specifications are subject to change without notice.

The device characteristics and parameters in this data sheet can and do vary in different applications and actual device performance may vary over time. Users should verify actual device performance in their specific applications.

Applications

- Sensor protection
- Signal line protection

P850-G Series Dual TBU® High-Speed Protectors

BOURNS®

Typical Performance Characteristics

V-I Characteristics

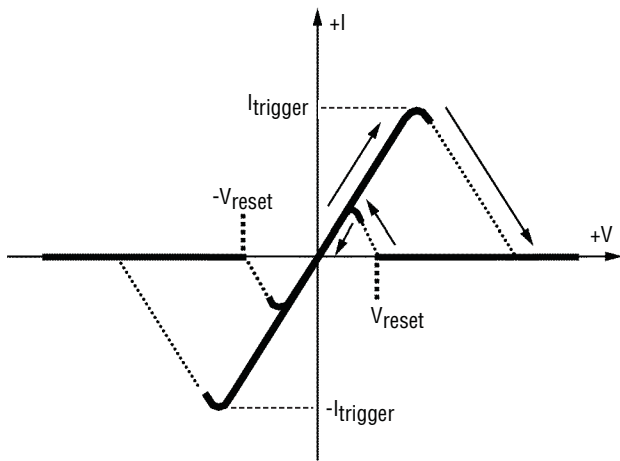

Time to Block vs. Fault Current

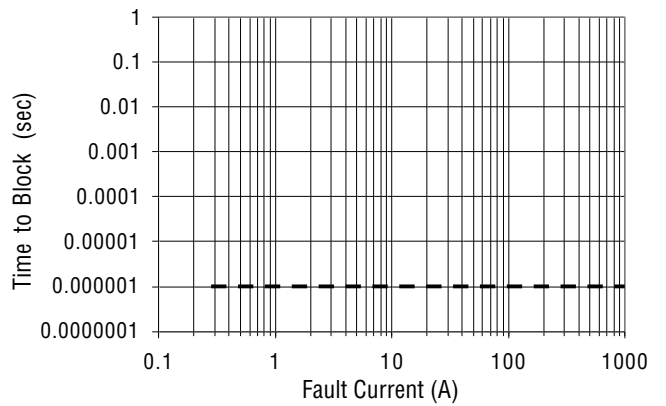

Trigger Current Temperature

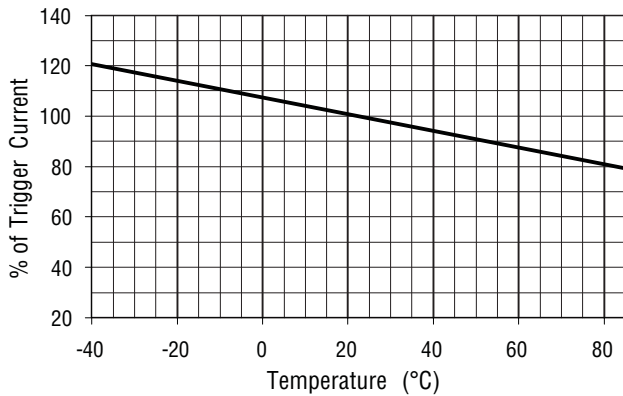

Specifications are subject to change without notice. The device characteristics and parameters in this data sheet can and do vary in different applications and actual device performance may vary over time. Users should verify actual device performance in their specific applications.

P850-G Series Dual TBU® High-Speed Protectors

BOURNS®

Operational Characteristics

The graphs below demonstrate the operational characteristics of the TBU® device. For each graph the fault voltage, protected side voltage, and current is presented.

TEST CONFIGURATION DIAGRAM

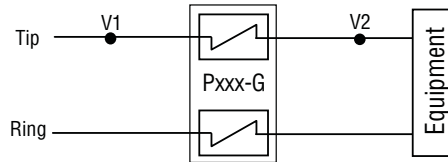

P850-G Lightning, 850 V

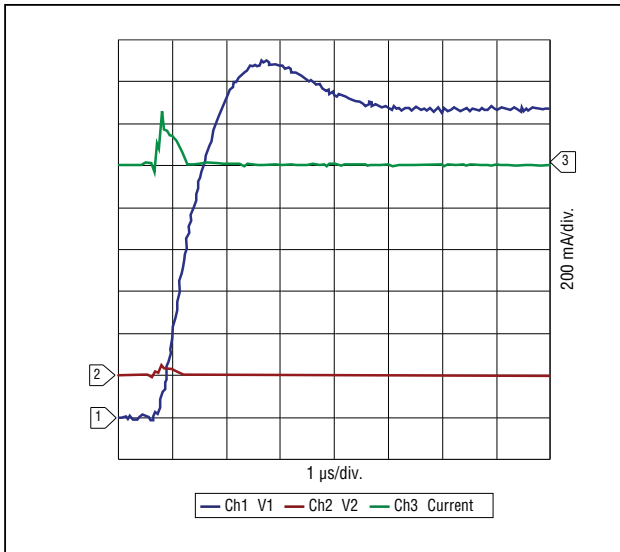

P850-G Power Fault, 230 Vrms, 25 A

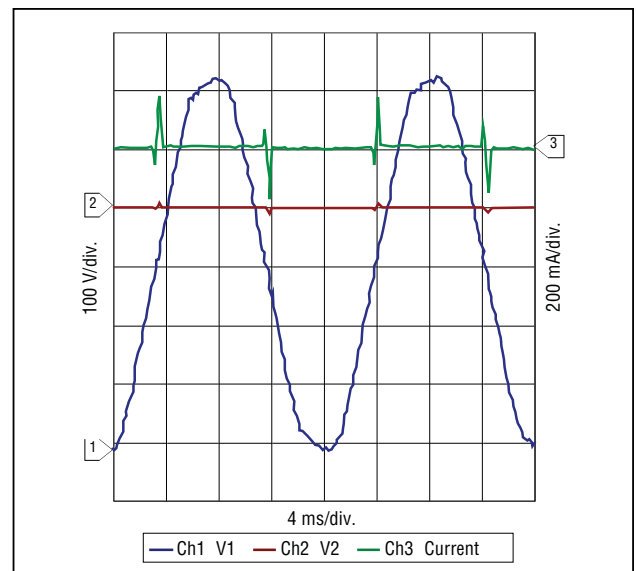

Specifications are subject to change without notice.

The device characteristics and parameters in this data sheet can and do vary in different applications and actual device performance may vary over time. Users should verify actual device performance in their specific applications.

P850-G Series Dual TBU® High-Speed Protectors

BOURNS®

Product Dimensions

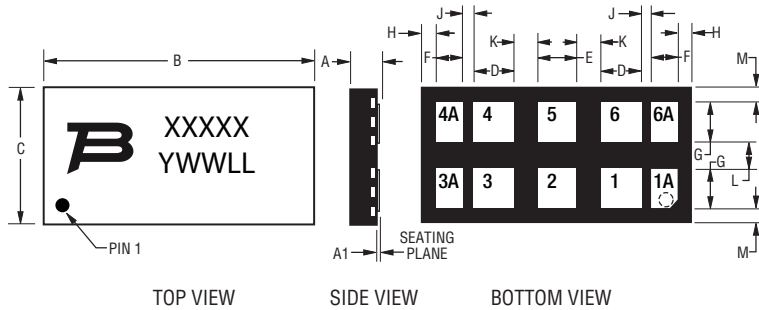

Pads 1A and 1 are internally connected; the same for pads 3A with 3, 4A with 4, and 6A with 6. This allows for one PCB layout to accommodate the Model P850.

| Dim. | P850-G | | |
|------|-----------------|-----------------|-----------------|
| | Min. | Typ. | Max. |
| A | 0.80 (.031) | 0.90 (.035) | 1.00 (.039) |
| A1 | 0.00 (.000) | 0.025 (.001) | 0.05 (.002) |
| B | 8.15 (.321) | 8.25 (.325) | 8.35 (.329) |
| C | 3.90 (0.154) | 4.00 (0.157) | 4.10 (0.161) |
| D | 1.15 (.045) | 1.25 (.049) | 1.35 (.053) |
| E | 1.05 (.041) | 1.15 (.045) | 1.25 (.049) |
| F | 0.725 (.029) | 0.825 (.032) | 0.925 (.036) |
| G | 1.10 (.043) | 1.20 (.047) | 1.30 (.051) |
| H | 0.375 (.015) | 0.425 (.017) | 0.475 (.019) |
| J | 0.25 (.010) | 0.30 (.012) | 0.35 (.014) |
| K | 0.70 (.028) | 0.75 (.030) | 0.80 (.031) |
| L | 0.70 (.028) | 0.75 (.030) | 0.80 (.031) |
| M | 0.375 (.015) | 0.425 (.017) | 0.475 (.018) |

Recommended Pad Layout

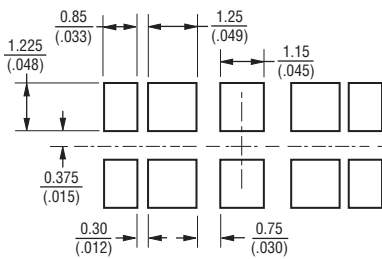

Pad Designation

| Pad # | Apply | Pad # | Apply |
|-------|---------|-------|----------|
| 1A | Tip In | 4A | Ring Out |
| 1 | Tip In | 4 | Ring Out |
| 2 | NC | 5 | NC |
| 3 | Tip Out | 6 | Ring In |
| 3A | Tip Out | 6A | Ring In |

NC = Solder to PCB; do not make electrical connection, do not connect to ground.

TBU® devices have matte-tin termination finish. Suggested layout should use non-solder mask define (NSMD). Recommended stencil thickness is 0.10-0.12 mm (.004-.005 in.) with stencil opening size 0.025 mm (.0010 in.) less than the device pad size. As when heat sinking any power device, it is recommended that, wherever possible, extra PCB copper area is allowed. For minimum parasitic capacitance, do not allow any signal, ground or power signals beneath any of the pads of the device.

DIMENSIONS: $\frac{\text{MM}}{\text{(INCHES)}}$

Thermal Resistances

| Part # | Symbol | Parameter | Value | Unit |
|--------|---------------|-------------------------------------|-------|------|
| P850-G | $R_{th(j-a)}$ | Junction to leads (package) | 119 | °C/W |
| | | Junction to leads (per TBU® device) | 215 | °C/W |

Block Diagram

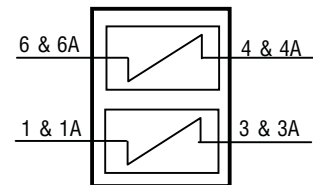

Reflow Profile

| Profile Feature | Pb-Free Assembly |
|---|------------------|
| Average Ramp-Up Rate (T _{smax} to T _p) | 3 °C/sec. max. |
| Preheat | |
| - Temperature Min. (T _{smin}) | 150 °C |
| - Temperature Max. (T _{smax}) | 200 °C |
| - Time (t _{smin} to t _{smax}) | 60-180 sec. |
| Time maintained above: | |
| - Temperature (T _L) | 217 °C |
| - Time (t _L) | 60-150 sec. |
| Peak/Classification Temperature (T _p) | 260 °C |
| Time within 5 °C of Actual Peak Temp. (t _p) | 20-40 sec. |
| Ramp-Down Rate | 6 °C/sec. max. |
| Time 25 °C to Peak Temperature | 8 min. max. |

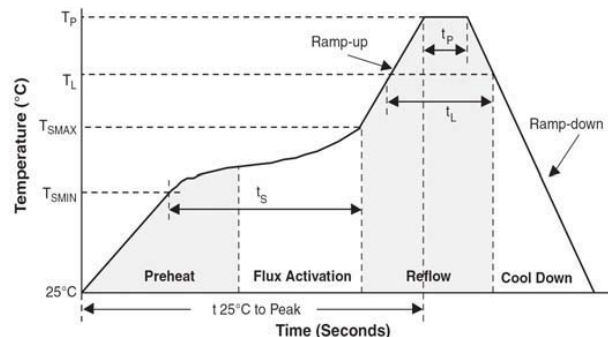

Specifications are subject to change without notice. The device characteristics and parameters in this data sheet can and do vary in different applications and actual device performance may vary over time. Users should verify actual device performance in their specific applications.

P850-G Series Dual TBU® High-Speed Protectors

BOURNS®

How to Order

P 850 - G 120 - WH

Form Factor _____

P = Two TBU® protectors in one device

Impulse Voltage Rating _____

850 = 850 V

Directional Indication for Paired Devices _____

G = Bidirectional

Top Indicator _____

120 = 100 mA

200 = 200 mA

Typical Part Marking

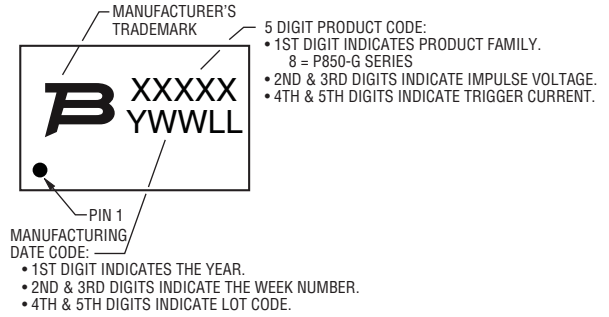

Packaging Specifications (per EIA468-B)

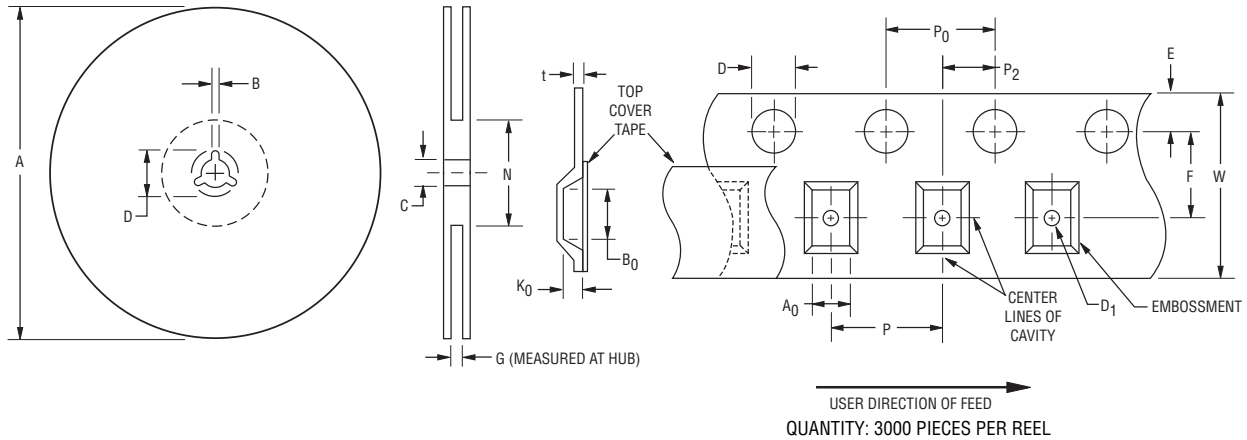

| A | | B | | C | | D | | G | N |
|----------|----------|--------|--------|--------|--------|--------|------|--------|---------|
| Min. | Max. | Min. | Max. | Min. | Max. | Min. | Max. | Ref. | Ref. |
| 326 | 330.25 | 1.5 | 2.5 | 12.8 | 13.5 | 20.2 | - | 16.5 | 102 |
| (12.835) | (13.002) | (.059) | (.098) | (.504) | (.531) | (.795) | | (.650) | (4.016) |

| A ₀ | | B ₀ | | D | | D ₁ | | E | | F | |
|----------------|--------|----------------|--------|----------------|--------|----------------|--------|--------|--------|--------|--------|
| Min. | Max. | Min. | Max. | Min. | Max. | Min. | Max. | Min. | Max. | Min. | max. |
| 4.2 | 4.4 | 8.45 | 8.65 | 1.5 | 1.6 | 1.5 | - | 1.65 | 1.85 | 7.4 | 7.6 |
| (.165) | (.173) | (.333) | (.341) | (.059) | (.063) | (.059) | | (.065) | (.073) | (.291) | (.299) |
| K ₀ | | P | | P ₀ | | P ₂ | | t | | W | |
| Min. | Max. | Min. | Max. | Min. | Max. | Min. | Max. | Min. | Max. | Min. | Max. |
| 1.1 | 1.3 | 7.9 | 8.1 | 3.9 | 4.1 | 1.9 | 2.1 | 0.25 | 0.35 | 15.7 | 16.3 |
| (.043) | (.051) | (.311) | (.319) | (.159) | (.161) | (.075) | (.083) | (.010) | (.014) | (.618) | (.642) |

DIMENSIONS: $\frac{\text{MM}}{\text{(INCHES)}}$

Specifications are subject to change without notice.

The device characteristics and parameters in this data sheet can and do vary in different applications and actual device performance may vary over time. Users should verify actual device performance in their specific applications.

P850-G Series Dual TBU® High-Speed Protectors



Reference Designs

A cost-effective protection solution combines the Bourns® TBU® protection device with a pair of MOVs or Bourns® GDTs and a diode bridge. The diagram below illustrates a common configuration of these components. The graphs to the right demonstrate the operational characteristics of the circuit.

For new SLIC applications, we recommend that customers evaluate our new TBU-PL series.

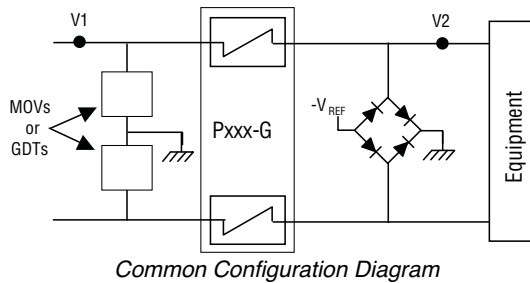

| P850-G Configuration (ITU-T K.20, K.21, K.20E, K.21E, K.45) | | | |
|---|------|-----------------------------|-----------------------|
| Product | Qty. | Part Number | Source |
| TBU® Device | 1 | P850-G120-WH | Bourns, Inc. |
| MOV | 2 | MOV-10D361K | Bourns, Inc. |
| Diode bridge | 2 | GSD2004S-V MMBD2004S | Vishay Diodes Inc. |

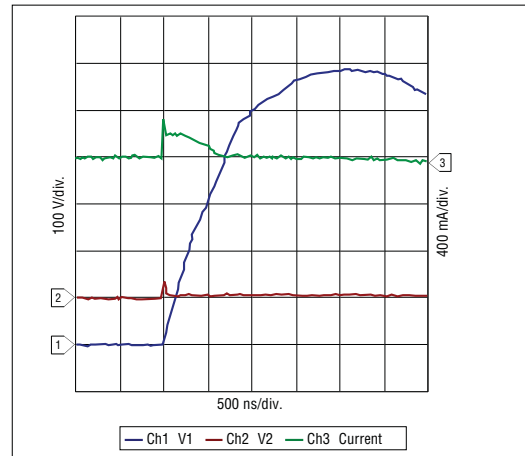

P850-G Solution: 4000 V Lightning 10/700 μsec, 100 A



Asia-Pacific: Tel: +886-2 2562-4117 • Fax: +886-2 2562-4116

EMEA: Tel: +36 88 520 390 • Fax: +36 88 520 211

The Americas: Tel: +1-951 781-5500 • Fax: +1-951 781-5700

www.bourns.com

REV. 09/15

"TBU" is a registered trademark of Bourns, Inc. in the United States and other countries.

Specifications are subject to change without notice.

The device characteristics and parameters in this data sheet can and do vary in different applications and actual device performance may vary over time. Users should verify actual device performance in their specific applications.

Mouser Electronics

Authorized Distributor

Click to View Pricing, Inventory, Delivery & Lifecycle Information:

[Bourns:](#)

[P850-G120-WH](#) [C650-260-WH](#) [C650-100-WH](#) [P850-G200-WH](#) [C850-180-WH](#) [C850-260-WH](#)