

MODEL TL-5934

International size reference: 1/10D, ER32L65

TECHNICAL DATA

(Typical values @+25°C for batteries stored for one year or less)

■ Nominal capacity @ 1 mA, to 2V	1 Ah
■ Rated voltage	3.6 V
■ Maximum recommended continuous current	10 mA
■ Maximum pulse current capability	50 mA
■ Weight	16.3 g (0.57 oz)
■ Volume	5.2 cc
■ Operating temperature range	-55°C to +85°C
■ Li metal content	approx. 0.3 g
■ U.L. Component Recognition, MH 12193	

TADIRAN LITHIUM BATTERIES

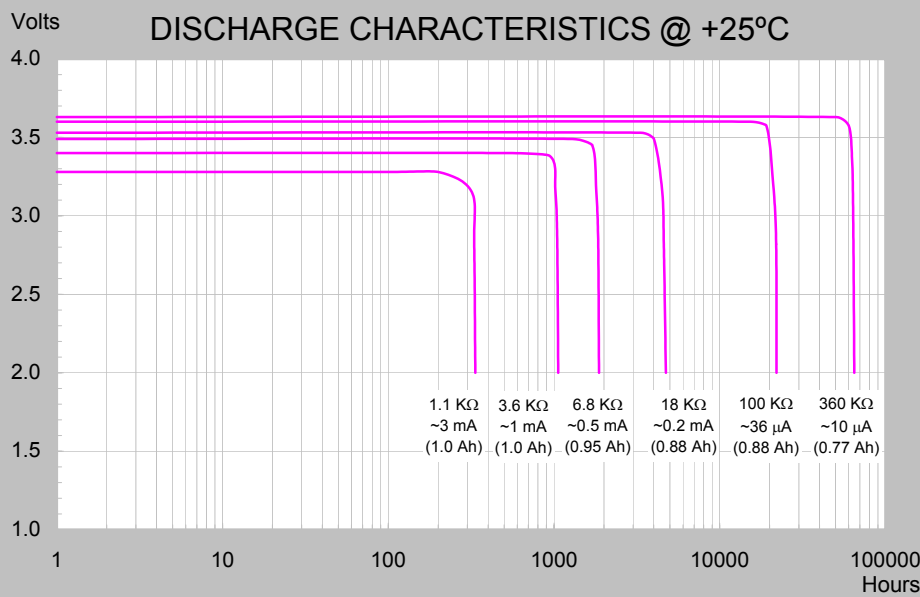
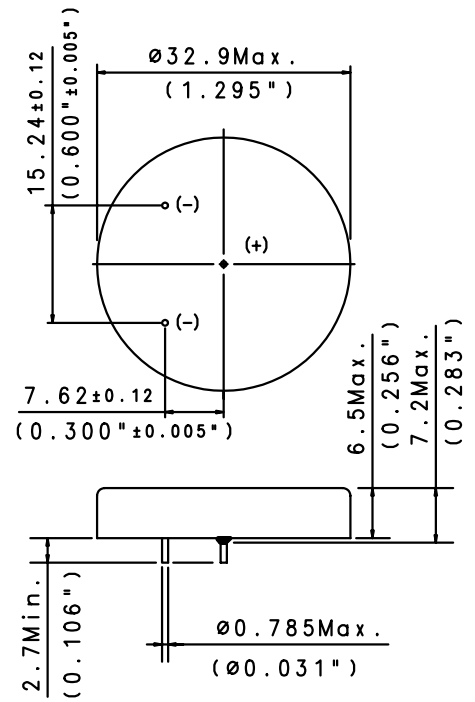

ORDERING NO.

TERMINAL MATERIAL : TIN PLATED NICKEL
CATALOGUE NO. : 15-5934-41500

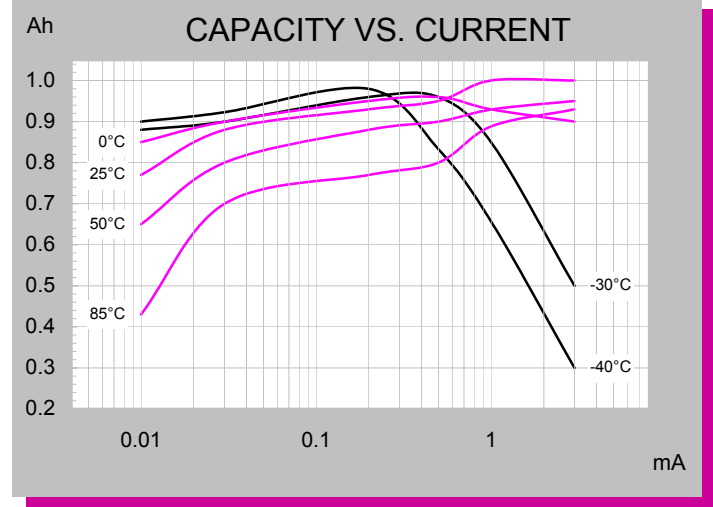
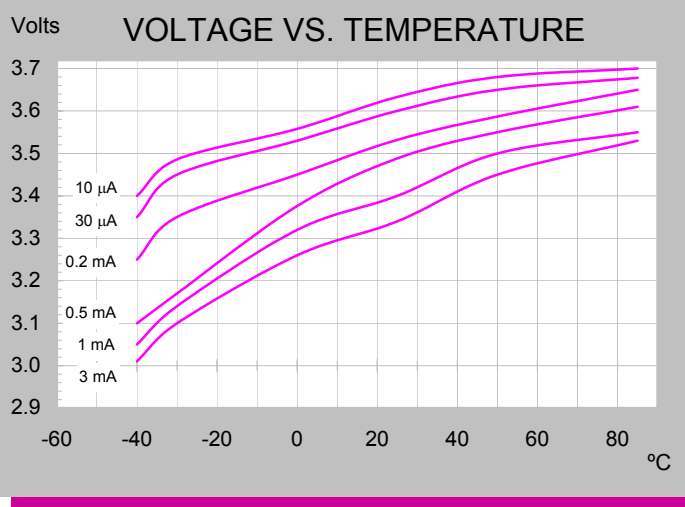

iXtra - Long Term High Performance

Note: Any presentations in this data sheet concerning performance are for information purpose only and are not construed as warranties either expressed or implied, of future performance.

ECN 1501879 Rev. B 11/08

TL-5934

CELL FEATURES

- 3.6 V Primary lithium-thionyl chloride (Li-SOCl₂)
- Fast voltage recovery after long term storage and/or usage
- High energy density
- High and stable operating voltage
- Low self discharge rate
- Wafer construction
- Hermetic glass-to-metal-sealing
- Non-flammable electrolyte

TADIRAN LITHIUM BATTERIES

MAIN APPLICATIONS

- Utility meters (elect., water & gas)
- Automatic meter reading
- RF systems
- Sensors & monitoring systems
- Tracking systems
- Wireless security systems
- Automotive electronics
- Industrial electronics
- Ultra Low Power (ULP)

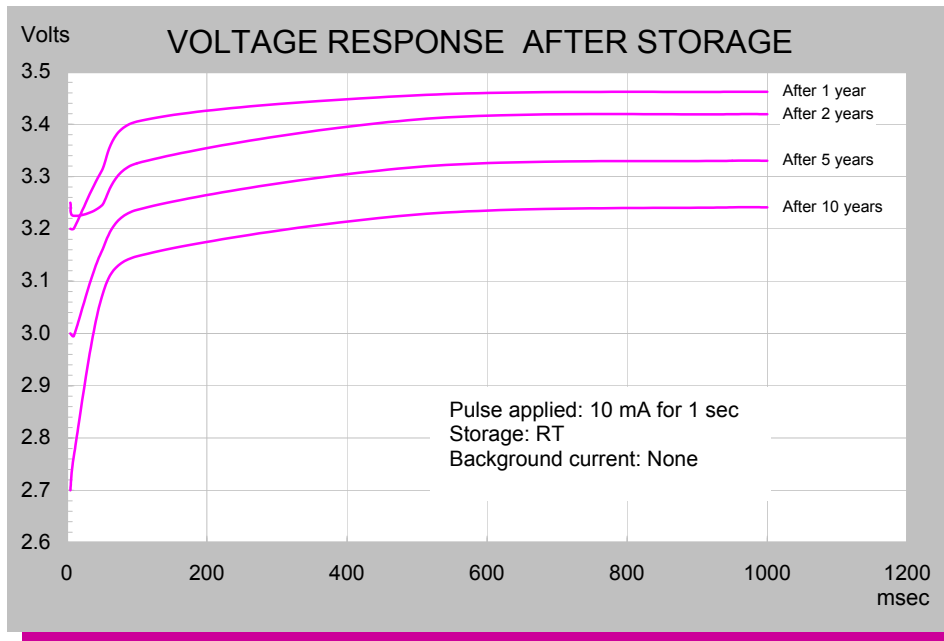

STORAGE CONDITIONS

- Cells should be stored in a clean & dry (less than 30 % RH) area

For updated information please visit our website www.tadiranbat.com

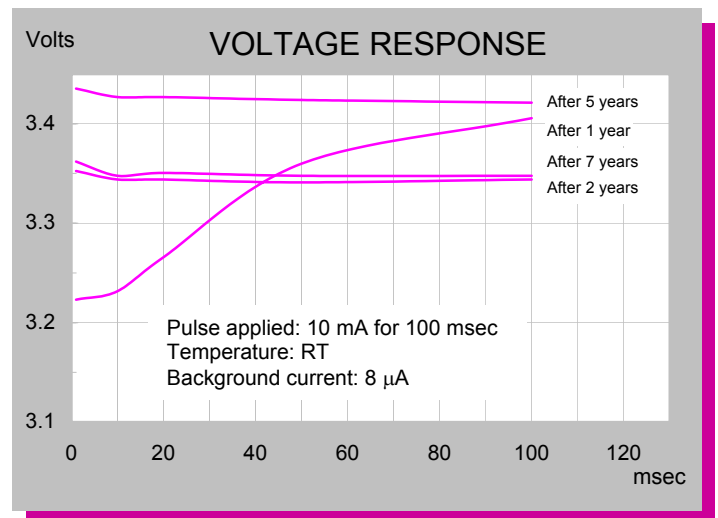
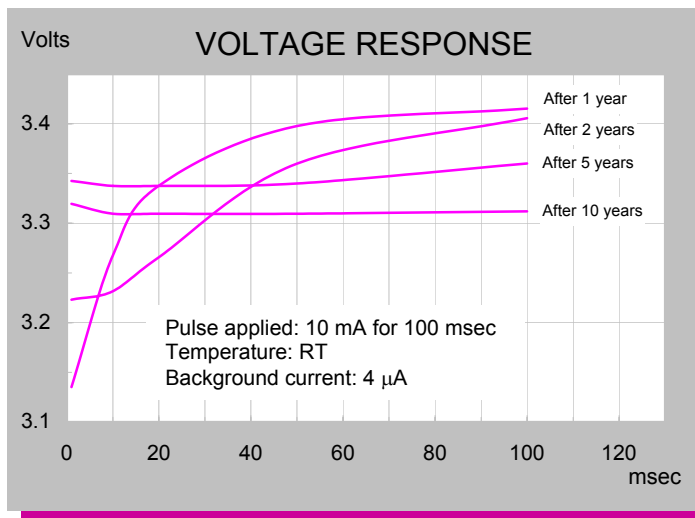

iXtra - Long Term High Performance

Note: Any presentations in this data sheet concerning performance are for information purpose only and are not construed as warranties either expressed or implied, of future performance.

ECN 1501879 Rev. B 11/08

Mouser Electronics

Authorized Distributor

Click to View Pricing, Inventory, Delivery & Lifecycle Information:

[Tadiran Batteries:](#)

[TL5934P](#)