

DATA SHEET

CDC7630/7631 and DDC2353/2354 Series: Zero Bias Silicon Schottky Barrier Detector Diodes

Applications

- Microwave integrated circuits
- Detectors

Features

- High sensitivity
- Low video impedance



Skyworks Green™ products are compliant with all applicable legislation and are halogen-free. For additional information, refer to *Skyworks Definition of Green™*, document number SQ04-0074.

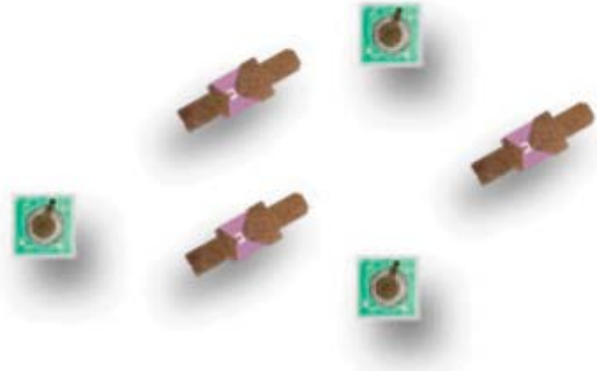

Description

Skyworks bare die and beam-lead zero-bias Schottky barrier detector diodes are designed for applications through the K band. The choice of barrier metal and process techniques results in a group of diodes with a wide selection of video impedance ranges.

The CDC and DDC series of Schottky diodes are especially well suited for use in Microwave Integrated Circuit (MIC) applications where the chip and wire approach is desirable. Mounted beam-lead diodes can be easily used in MIC, stripline, or other such circuitry.

Applications

The CDC and DDC series of zero-bias Schottky diodes are designed for detector applications through 26 GHz and are useful up to 40 GHz. They require no bias and operate efficiently even at tangential signal power levels. Since they require no bias, noise is at a minimum. A low video impedance means a short R-C time constant and, therefore, wide video bandwidth and excellent pulse fidelity.

As power monitors, these diodes may also be used to directly drive metering circuits even at low power input levels. These diodes are categorized by Tangential Signal Sensitivity (TSS), voltage output, and video impedance for detector applications.

TSS is a parameter that best describes the use of a diode as a video detector. It is defined as the amount of signal power, below a one milliwatt reference level, required to produce an output pulse with an amplitude sufficient to raise noise fluctuations by an amount equal to the average noise level. TSS is approximately 4 dB above the minimum detectable signal.

Voltage output is another useful parameter since it can be used in the design of threshold detectors and power monitor circuits. Since voltage output is a function of the diode's video impedance, a different minimum value is specified for each video impedance range.

Electrical and Mechanical Specifications

The absolute maximum ratings for the CDC and DDC series of Schottky diodes are provided in Table 1. Electrical and physical specifications are provided in Table 2. SPICE model parameters for the CDC7630/7631 series are defined in Table 3.

Typical performance characteristics are shown in Figures 1 through 8. Typical video detector circuits are shown in Figure 9. The multi-octave, high-sensitivity circuit would be used in Electronic Countermeasures (ECM) and similar applications. An RF matching structure that presents maximum power at the diode junction must be incorporated to ensure maximum sensitivity.

The broadband low-sensitivity circuit would be used where a low input VSWR is required. In this circuit, low VSWR is accomplished by the use of the 50 Ω terminating resistor. Sensitivity, however, is degraded by typically 10 dB from the multi-octave, high-sensitivity circuit. The most common use for this circuit is in a broadband, flat detector used primarily in the laboratory.

Package dimensions are provided in Figures 10 and 11. Additional bonding and handling methods are contained in the Skyworks Application Notes, *Waffle Pack Chip Carrier Handling/Opening Procedure* (document #200146) and *Diode Chips, Beam-Lead Diodes, Capacitors: Bonding Methods and Packaging* (document #200532).

Table 1. CDC7630/7631 and DDC2353/2354 Diode Series Absolute Maximum Ratings (Note 1)

Parameter	Symbol	Minimum	Maximum	Units
Reverse voltage	V _R		2	V
Forward current	I _F		100	mA
RF input power @ T _A = 25 °C	P _D		75	mW
Storage temperature	T _{STG}	-60	+200	°C
Operating temperature	T _A	-55	+150	°C
Electrostatic discharge: Human Body Model (HBM), Class 0	ESD		<250	V

Note 1: Exposure to maximum rating conditions for extended periods may reduce device reliability. There is no damage to device with only one parameter set at the limit and all other parameters set at or below their nominal value. Exceeding any of the limits listed here may result in permanent damage to the device.

CAUTION: Although this device is designed to be as robust as possible, electrostatic discharge (ESD) can damage this device. This device must be protected at all times from ESD. Static charges may easily produce potentials of several kilovolts on the human body or equipment, which can discharge without detection. Industry-standard ESD precautions should be used at all times.

Table 2. CDC7630/7631 and DDC2353/2354 Diode Series Electrical Specifications (Note 1)
(T_A = +25 °C, Characteristic Impedance [Z₀] = 50 Ω, Unless Otherwise Noted)

Part Number	Min. Detected Output Voltage, E _O (mV)	Video Impedance, Z _v (Ω)	Max. TSS (dBm)	Outline Drawing
DDC2353-000	8	2000 to 6500	-52	491-006
DDC2354-000	15	5000 to 15000	-56	491-006
CDC7630-000	8	2000 to 6500	-52	571-006
CDC7631-000	15	5000 to 15000	-56	571-006

Note 1: Performance is guaranteed only under the conditions listed in this table.

Typical Performance Characteristics

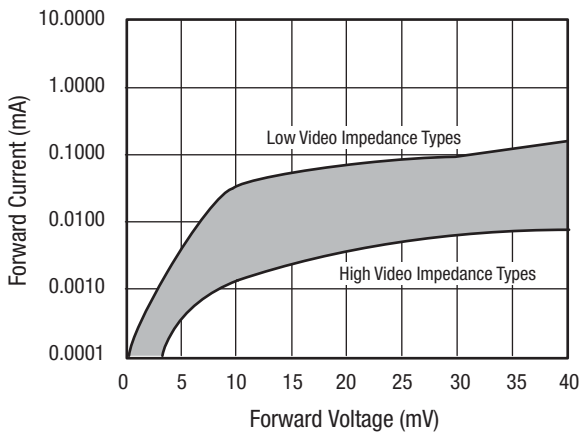

**Figure 1. Zero Bias Schottky Detector Diodes
Typical Forward DC Characteristics**

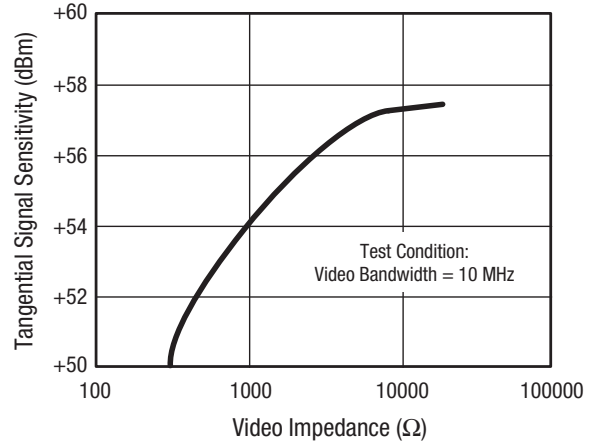

**Figure 2. Typical Zero Bias X-Band Detector Diodes
TSS vs Video Impedance**

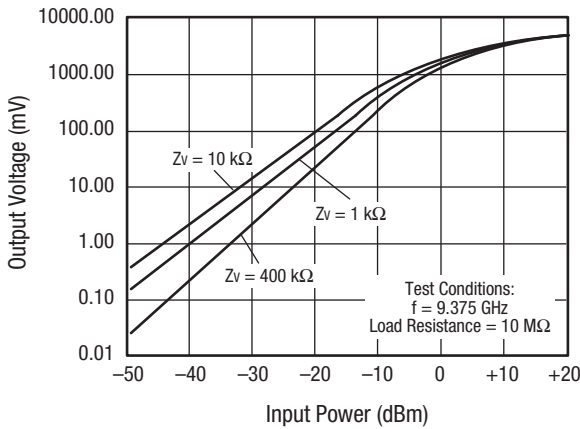

**Figure 3. Typical Zero Bias X-Band Detector Diodes
Output Voltage vs Input Power as a Function of Video Impedance**

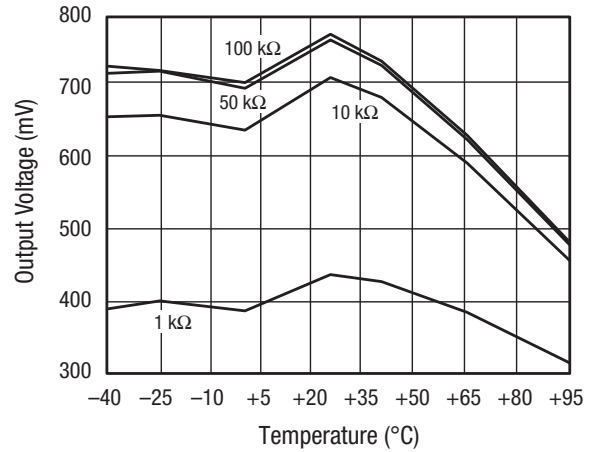

**Figure 4. Output Voltage vs Temperature
Over Load Resistance @ 0 dBm**

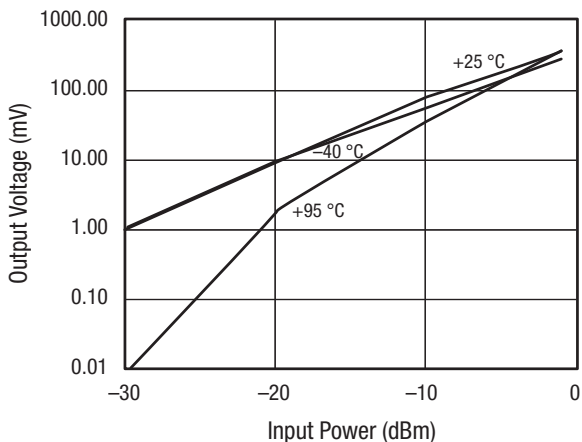

Figure 5. Output Voltage vs Input Power Over Temperature (Load Resistance = 1 kΩ)

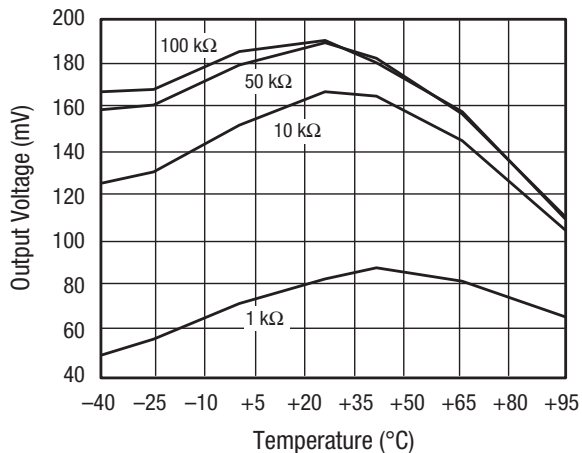

Figure 6. Output Voltage vs Temperature Over Load Resistance @ -10 dBm

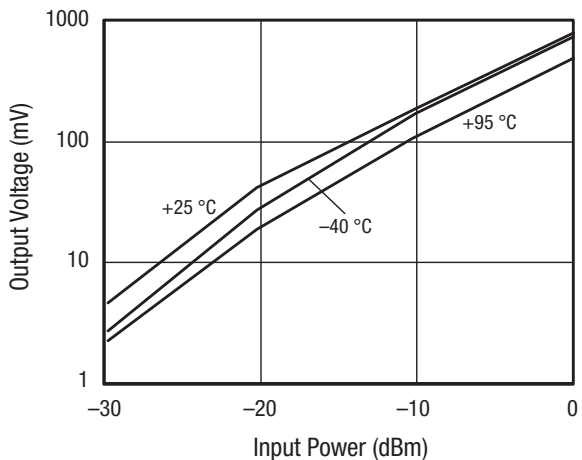

Figure 7. Output Voltage vs Input Power Over Temperature (Load Resistance = 100 kΩ)

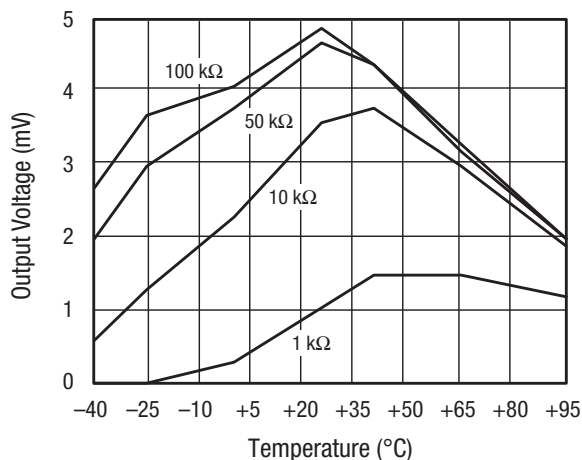
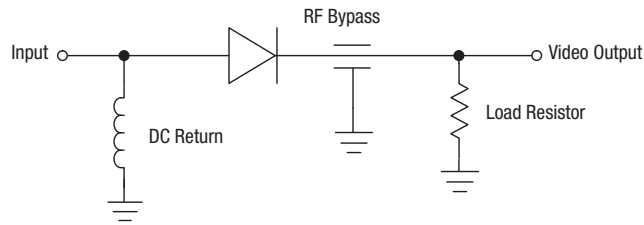

Figure 8. Output Voltage vs Temperature Over Load Resistance @ -30 dBm

Table 4. SPICE Model Parameters

Parameter	Units	Part Number	
		CDC7630-000	CDC7631-000
Is	A	5E-06	3.8E-06
Rs	Ω	20	51
N	–	1.05	1.05
TT	sec	1E-11	1E-11
CJO	pF	0.14	0.08
M	–	0.4	0.4
Eg	eV	0.69	0.69
XTI	–	2	2
Fc	–	0.5	0.5
Bv	V	2	2
Ibv	A	1E-04	1E-04
VJ	V	0.34	0.34



Multi-Octave: High-Sensitivity

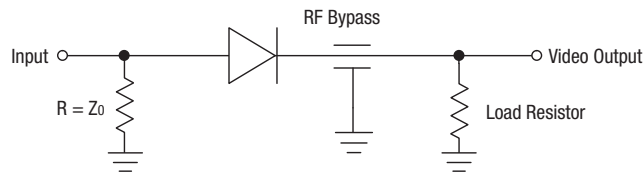

Broadband: Low-Sensitivity

Figure 9. Typical Video Detector Circuits

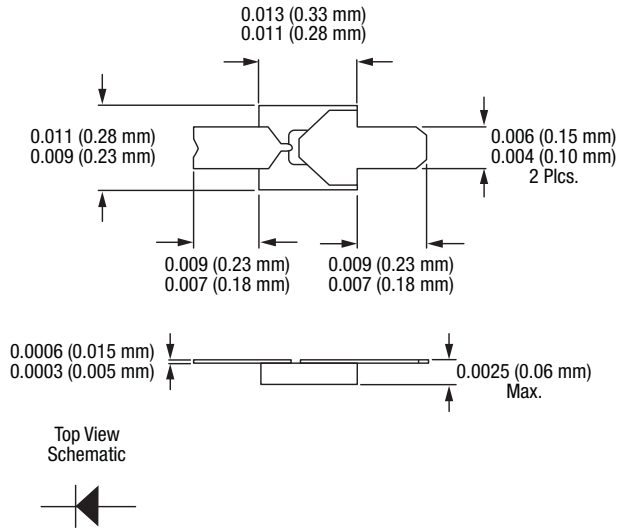

Dimensions are in inches (millimeters shown in parentheses)

Figure 10. 491-006 Package Dimensions

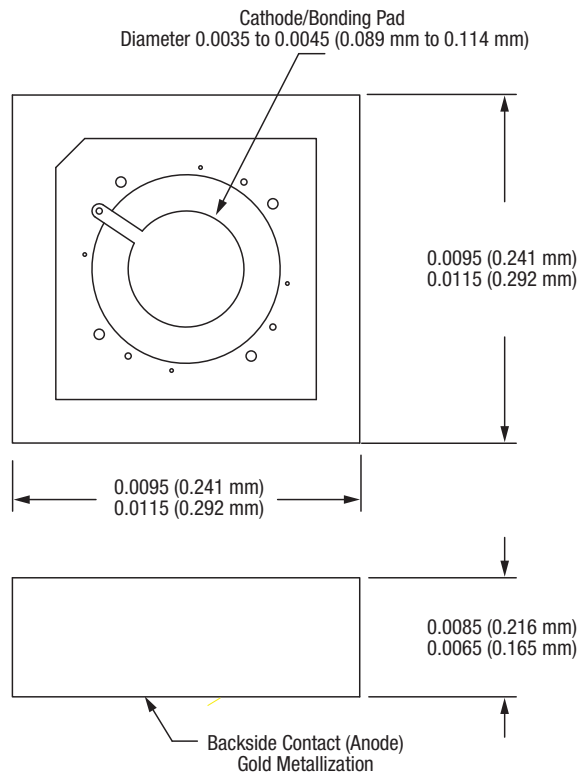

Dimensions are in inches (millimeters shown in parentheses)

S3181

Figure 11. 571-006 Package Dimensions

Copyright © 2002-2012, 2014 Skyworks Solutions, Inc. All Rights Reserved.

Information in this document is provided in connection with Skyworks Solutions, Inc. ("Skyworks") products or services. These materials, including the information contained herein, are provided by Skyworks as a service to its customers and may be used for informational purposes only by the customer. Skyworks assumes no responsibility for errors or omissions in these materials or the information contained herein. Skyworks may change its documentation, products, services, specifications or product descriptions at any time, without notice. Skyworks makes no commitment to update the materials or information and shall have no responsibility whatsoever for conflicts, incompatibilities, or other difficulties arising from any future changes.

No license, whether express, implied, by estoppel or otherwise, is granted to any intellectual property rights by this document. Skyworks assumes no liability for any materials, products or information provided hereunder, including the sale, distribution, reproduction or use of Skyworks products, information or materials, except as may be provided in Skyworks Terms and Conditions of Sale.

THE MATERIALS, PRODUCTS AND INFORMATION ARE PROVIDED "AS IS" WITHOUT WARRANTY OF ANY KIND, WHETHER EXPRESS, IMPLIED, STATUTORY, OR OTHERWISE, INCLUDING FITNESS FOR A PARTICULAR PURPOSE OR USE, MERCHANTABILITY, PERFORMANCE, QUALITY OR NON-INFRINGEMENT OF ANY INTELLECTUAL PROPERTY RIGHT; ALL SUCH WARRANTIES ARE HEREBY EXPRESSLY DISCLAIMED. SKYWORKS DOES NOT WARRANT THE ACCURACY OR COMPLETENESS OF THE INFORMATION, TEXT, GRAPHICS OR OTHER ITEMS CONTAINED WITHIN THESE MATERIALS. SKYWORKS SHALL NOT BE LIABLE FOR ANY DAMAGES, INCLUDING BUT NOT LIMITED TO ANY SPECIAL, INDIRECT, INCIDENTAL, STATUTORY, OR CONSEQUENTIAL DAMAGES, INCLUDING WITHOUT LIMITATION, LOST REVENUES OR LOST PROFITS THAT MAY RESULT FROM THE USE OF THE MATERIALS OR INFORMATION, WHETHER OR NOT THE RECIPIENT OF MATERIALS HAS BEEN ADVISED OF THE POSSIBILITY OF SUCH DAMAGE.

Skyworks products are not intended for use in medical, lifesaving or life-sustaining applications, or other equipment in which the failure of the Skyworks products could lead to personal injury, death, physical or environmental damage. Skyworks customers using or selling Skyworks products for use in such applications do so at their own risk and agree to fully indemnify Skyworks for any damages resulting from such improper use or sale.

Customers are responsible for their products and applications using Skyworks products, which may deviate from published specifications as a result of design defects, errors, or operation of products outside of published parameters or design specifications. Customers should include design and operating safeguards to minimize these and other risks. Skyworks assumes no liability for applications assistance, customer product design, or damage to any equipment resulting from the use of Skyworks products outside of stated published specifications or parameters.

Skyworks and the Skyworks symbol are trademarks or registered trademarks of Skyworks Solutions, Inc., in the United States and other countries. Third-party brands and names are for identification purposes only, and are the property of their respective owners. Additional information, including relevant terms and conditions, posted at www.skyworksinc.com, are incorporated by reference.

Mouser Electronics

Authorized Distributor

Click to View Pricing, Inventory, Delivery & Lifecycle Information:

[Skyworks:](#)

[DDC2354-000](#) [DDC2353-000](#) [CDC7631-000](#) [CDC7630-000](#)