

92mm sq.

San Ace 92T



General Specifications

- Material Frame: Aluminum, Impeller: Plastics (Flammability: UL94V-1)
- Expected Life Refer to specifications (L10:Survival rate:90% at 85°C , rated voltage, and continuously run in a free air state)
- Lead Wire ⊕red ⊖black (Sensor) yellow (Control) brown
- Storage Temperature -40°C to +85°C (Non-condensing)

92×92×25mm (Mass : 150g) **9GT** type

Specifications

The following nos. have PWM controls and pulse sensors.

Model No.	Rated Voltage [V]	Operating Voltage Range [V]	PWM duty cycle [※] [%]	Rated Current [A]	Rated Input [W]	Rated Speed [min ⁻¹]	Max. Airflow [m ³ /min] [CFM]	Max. Static Pressure [Pa] [InchH ₂ O]	SPL [dB(A)]	Operating Temperature [°C]	Expected Life [h]
9GT0912P4J001	12	10.2 to 13.8	100	0.42	5.04	5,000	2.20 77.7	105 0.42	44	-40 to +85	40,000/85°C
			30	0.07	0.84	1,850	0.81 28.7	14.3 0.05	18		
9GT0924P4J001	24	20.4 to 27.6	100	0.21	5.04	5,000	2.20 77.7	105 0.42	44		
			30	0.05	1.20	1,850	0.81 28.7	14.3 0.05	18		

Note : Fan does not rotate when PWM duty cycle is 0%.

※PWM Frequency : 25kHz

Other sensor specifications are available as options. Please refer to the index (p. 507).

Dimensions (unit: mm)

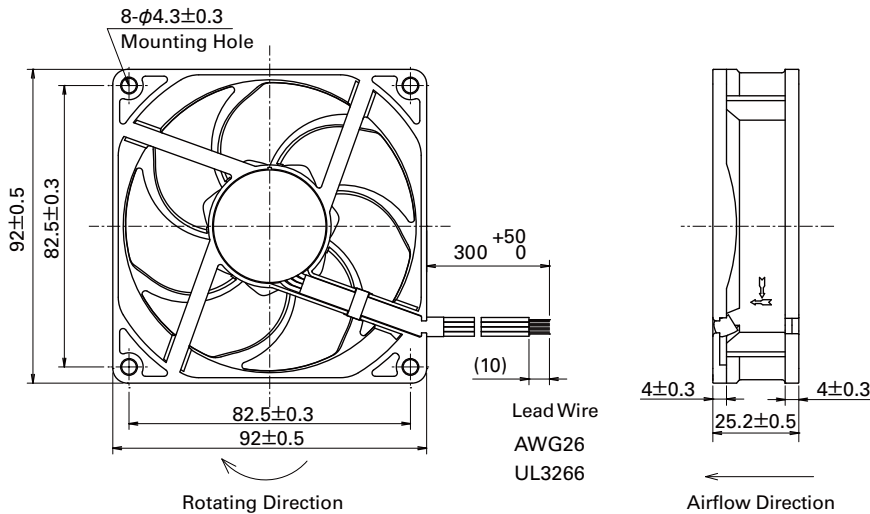

Options (unit: mm)

Finger Guards

Model : 109-099C Surface treatment : Nickel-chrome plating (silver) Color

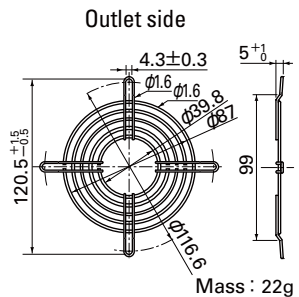

Model : 109-099E Surface treatment : Nickel-chrome plating (silver) Color
: 109-099H : Cation electropainting (black)

Inlet side, Outlet side

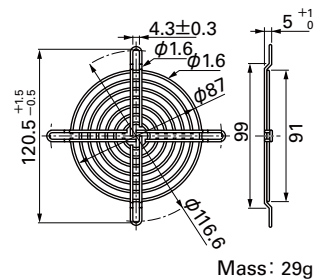

Reference Dimensions of Mounting Holes and Vent Opening (unit: mm)

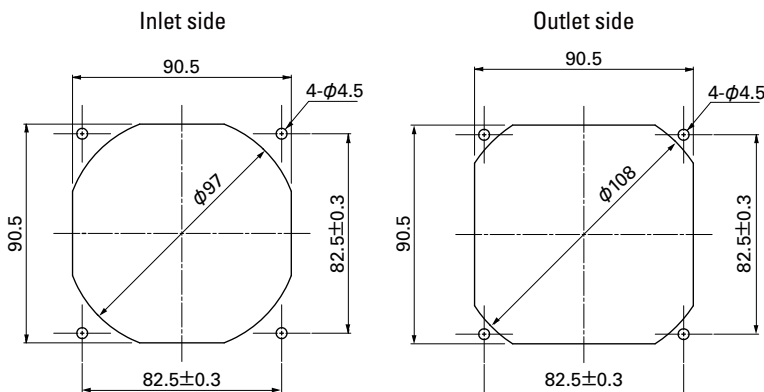

Airflow - Static Pressure Characteristics

PWM Duty Cycle

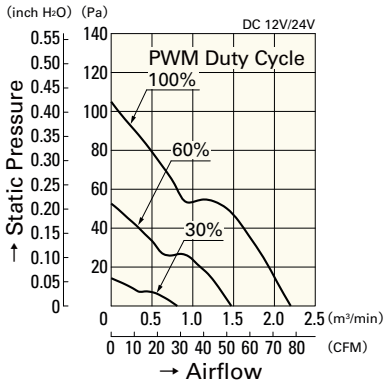

9GT0912P4J001

9GT0924P4J001

Operating Voltage Range

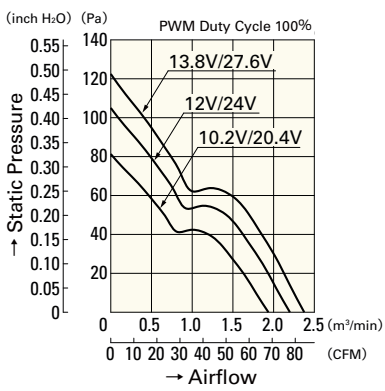

9GT0912P4J001

9GT0924P4J001

PWM Duty - Speed Characteristics Example

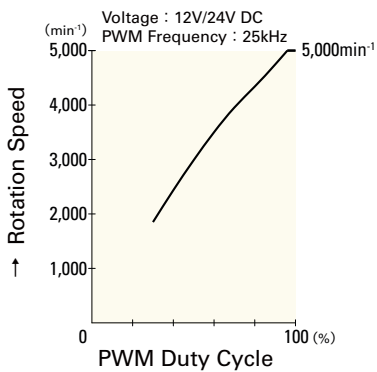

9GT0912P4J001

9GT0924P4J001

DC

Wide Temperature Range Fan 92mm

Mouser Electronics

Authorized Distributor

Click to View Pricing, Inventory, Delivery & Lifecycle Information:

Sanyo Denki:

[9GT0912P4J001](#) [9GT0924P4J001](#)