

40mm sq.

San Ace 40W



DC
Splash Proof Fan 40mm

General Specifications

- Material Frame: Aluminum (Black coating),
Impeller: Plastics (Flammability: UL94V-0)
- Expected Life Refer to specifications (Indoor, L10:Survival rate:90% at 60°C ,
rated voltage, and continuously run in a free air state)
- Lead Wire ⊕red ⊖black (Sensor) yellow (Control) brown
- Storage Temperature -30°C to +70°C (Non-condensing)

40×40×28mm (Mass : 70g) **IP 68** **9WL type** **High Airflow Long Life Fan**

Specifications

The following nos. **have PWM controls and pulse sensors.**

Model No.	Rated Voltage [V]	Operating Voltage Range [V]	PWM duty cycle [Hz] [%]	Rated Current [A]	Rated Input [W]	Rated Speed [min ⁻¹]	Max. Airflow [m ³ /min] [CFM]	Max. Static Pressure [Pa] [inchH ₂ O]	SPL [dB(A)]	Operating Temperature [°C]	Expected Life [h]
9WL0412P3J001	12	10.8 to 13.2	100	0.52	6.24	17,500	0.63 22.2	400 1.61	51	-20 to +70	150,000/60°C
			20	0.06	0.72	3,600	0.13 4.6	16.9 0.07	20		
9WL0412P3G001			100	0.40	4.80	15,500	0.56 19.7	310 1.24	47		
			20	0.06	0.72	3,300	0.12 4.2	14.0 0.06	18		
9WL0424P3J001	24	21.6 to 26.4	100	0.26	6.24	17,500	0.63 22.2	400 1.61	51		
			20	0.04	0.96	4,000	0.14 5.1	20.9 0.08	22		
9WL0424P3G001			100	0.20	4.80	15,500	0.56 19.7	310 1.24	47		
			20	0.04	0.96	3,000	0.11 3.8	11.6 0.05	16		

Note: Fan does not rotate when PWM duty cycle is 0%.

※PWM Frequency : 25kHz

Other sensor specifications are available as options. Please refer to the index (p. 511).

Dimensions (unit: mm)

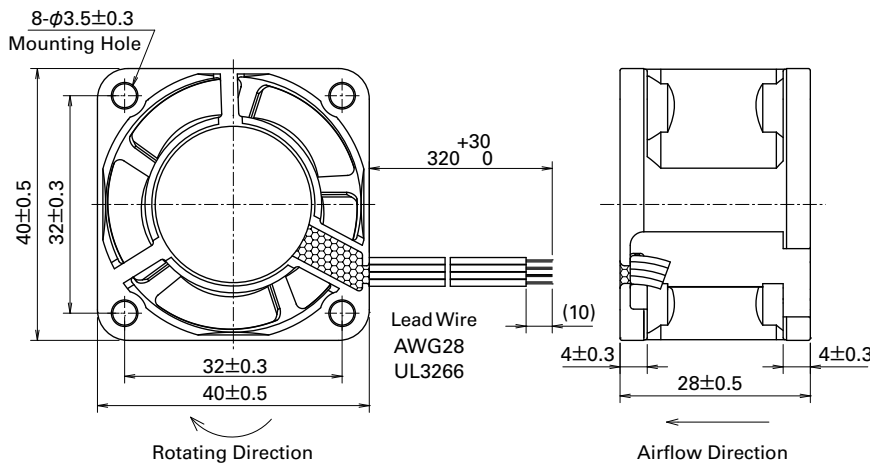

Reference Dimensions of Mounting Holes and Vent Opening (unit: mm)

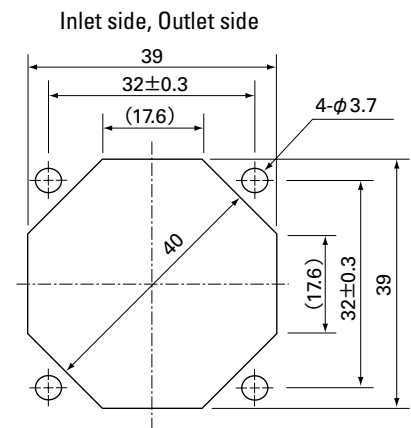

Options (unit: mm)

Finger Guards

Model : 109-059 Surface treatment : Nickel-chrome plating (silver)
: 109-059H : Cation electropainting (black)

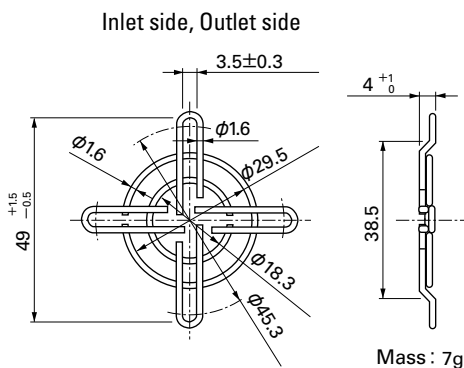

40mm sq.

San Ace 40W

40×40×28mm [Mass : 70g]

Airflow - Static Pressure Characteristics

PWM Duty Cycle

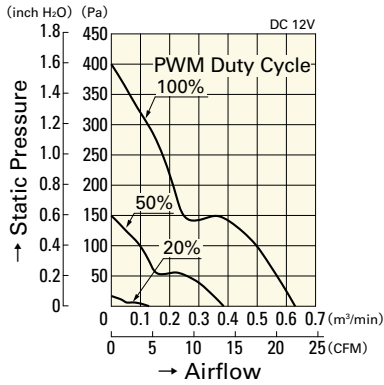

9WL0412P3J001

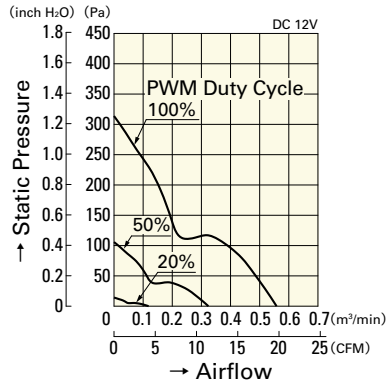

9WL0412P3G001

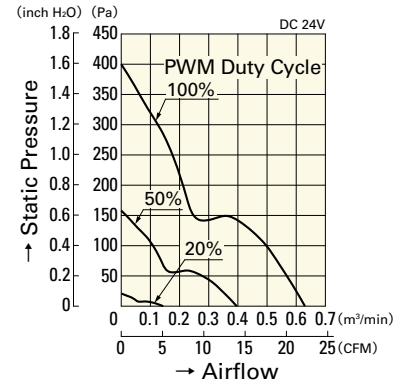

9WL0424P3J001

Operating Voltage Range

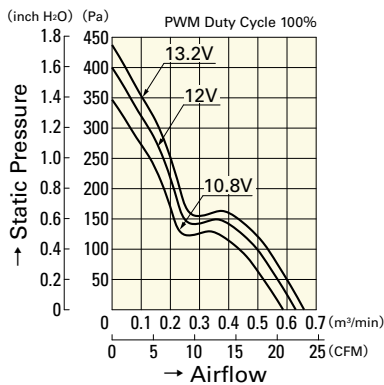

9WL0412P3J001

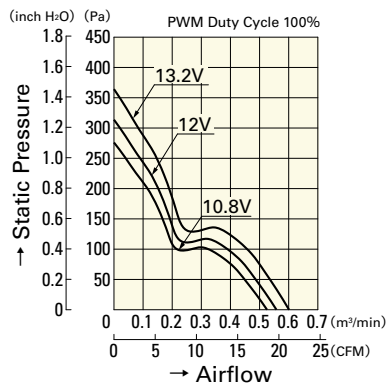

9WL0412P3G001

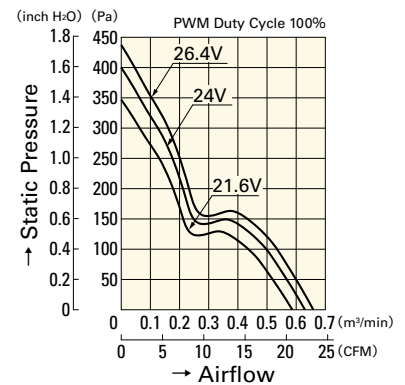

9WL0424P3J001

PWM Duty - Speed Characteristics Example

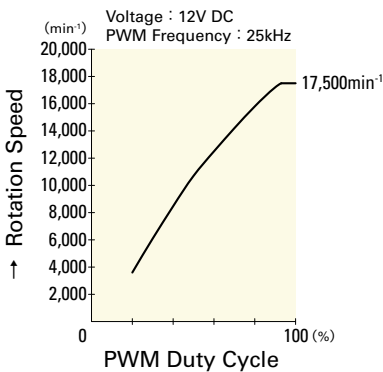

9WL0412P3J001

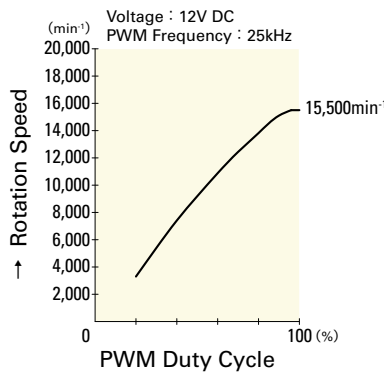

9WL0412P3G001

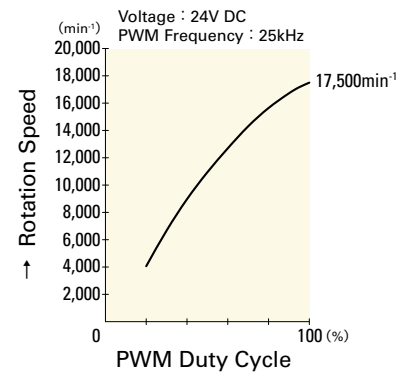

9WL0424P3J001

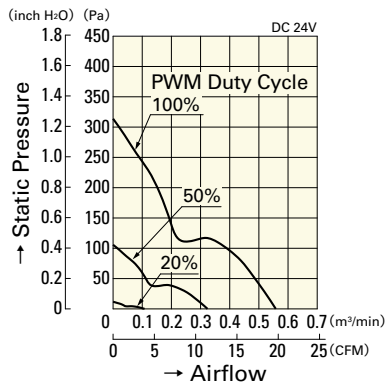

9WL0424P3G001

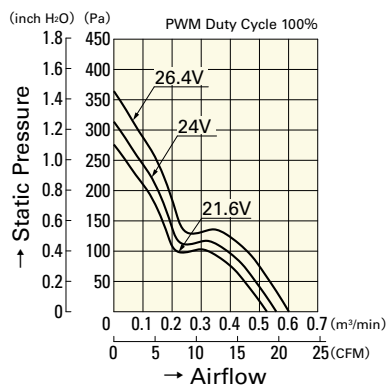

9WL0424P3G001

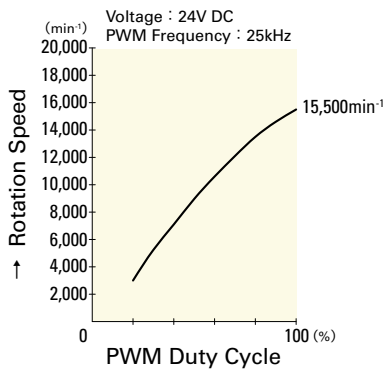

9WL0424P3G001

Mouser Electronics

Authorized Distributor

Click to View Pricing, Inventory, Delivery & Lifecycle Information:

[Sanyo Denki:](#)

[9WL0412P3J001](#) [9WL0424P3J001](#) [9WL0412P3G001](#) [9WL0424P3G001](#)