



38x38x28 mm

San Ace 38 9GA type Low Power Consumption Fan

General Specifications

- Material Frame: Plastic (Flammability: UL 94V-0), Impeller: Plastic (Flammability: UL 94V-0)
- Expected life See the table below. (L10 life: 90% survival rate for continuous operation in free air at 60°C, rated voltage)
- Motor protection function Locked rotor burnout protection, Reverse polarity protection
For details, please refer to p. 547.
- Dielectric strength 50/60 Hz, 500 VAC, for 1 minute (between lead wire conductors and frame)
- Insulation resistance 10 MΩ or more with a 500 VDC megger (between lead wire conductors and frame)
- Sound pressure level (SPL) At 1 m away from the air inlet
- Storage temperature -30 to +70°C (Non-condensing)
- Lead wire ⊕Red ⊖Black (Sensor) Yellow (Control) Brown
- Mass 52 g

Specifications

The models listed below **have ribs and pulse sensors with PWM control function.** For models without ribs, append "1" to the end of model numbers.

Model no.	Rated voltage [V]	Operating voltage range [V]	PWM duty cycle* [%]	Rated current [A]	Rated input [W]	Rated speed [min ⁻¹]	Max. airflow [m ³ /min] [CFM]	Max. static pressure [Pa] [inchH ₂ O]	SPL [dB (A)]	Operating temperature [°C]	Expected life [h]
9GA0312P3K001	12	10.8 to 13.2	100	0.62	7.4	25000	0.6 21.2	800 3.21	59.0	-20 to +70	40000/60°C (70000/40°C)
			0	0.06	0.7	3000	0.07 2.5	11 0.04	15.0		
9GA0312P3J001			100	0.52	6.2	23500	0.57 20.1	720 2.89	57.5		
			0	0.06	0.7	3000	0.07 2.5	11 0.04	15.0		
9GA0312P3G001			100	0.33	4.0	19000	0.45 15.9	460 1.85	53.0		
			0	0.06	0.7	3000	0.07 2.5	11 0.04	15.0		

* PWM frequency: 25 kHz

The following sensor and control options are available for selection.

Differs according to the model. Refer to the table on p. 570. Pulse sensor Lock sensor

Airflow - Static Pressure Characteristics / PWM Duty - Speed Characteristics Example

9GA0312P3K001 With pulse sensor with PWM control function

PWM duty cycle

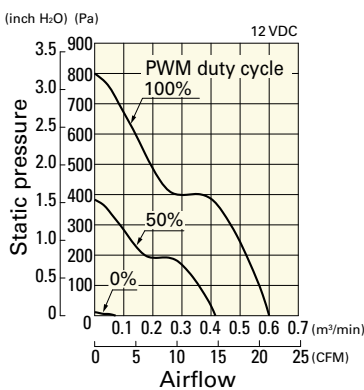

Operating voltage range

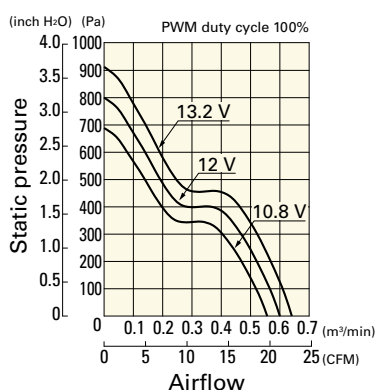

PWM duty - Speed characteristics example

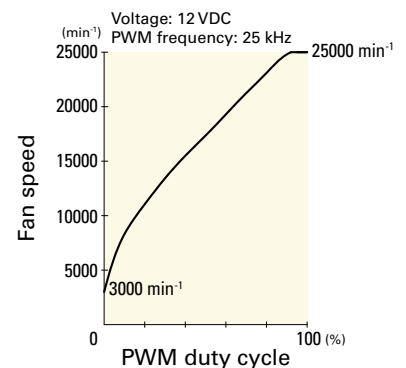

Airflow - Static Pressure Characteristics / PWM Duty - Speed Characteristics Example

9GA0312P3J001 With pulse sensor with PWM control function

PWM duty cycle

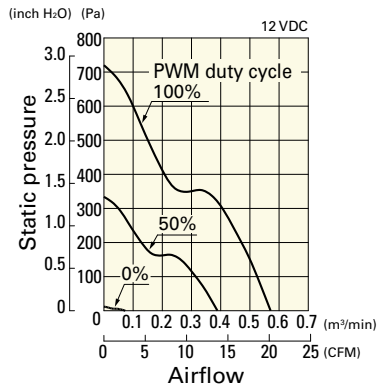

Operating voltage range

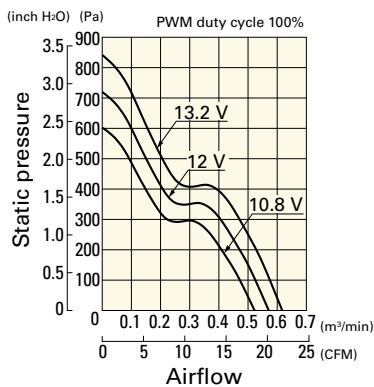

PWM duty - Speed characteristics example

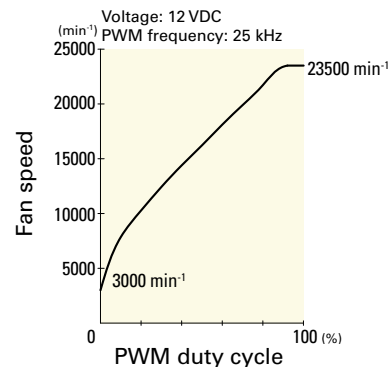

9GA0312P3G001 With pulse sensor with PWM control function

PWM duty cycle

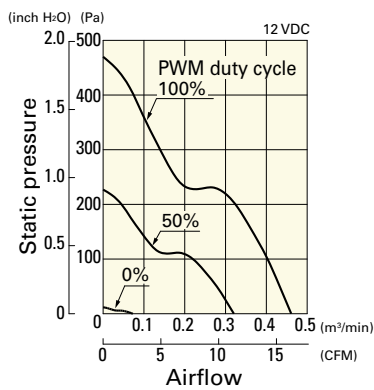

Operating voltage range

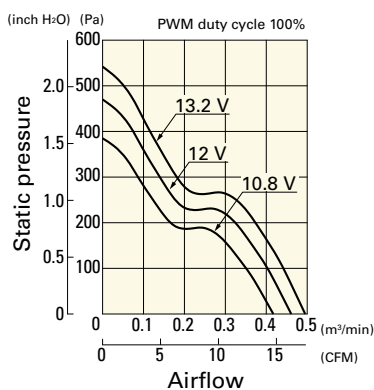

PWM duty - Speed characteristics example

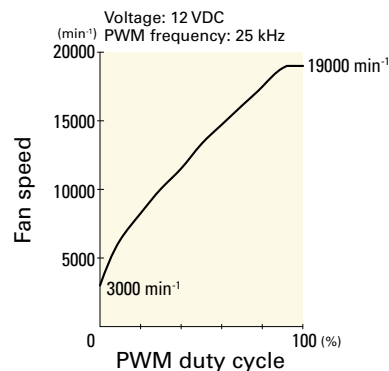

Dimensions (unit: mm) (With ribs)

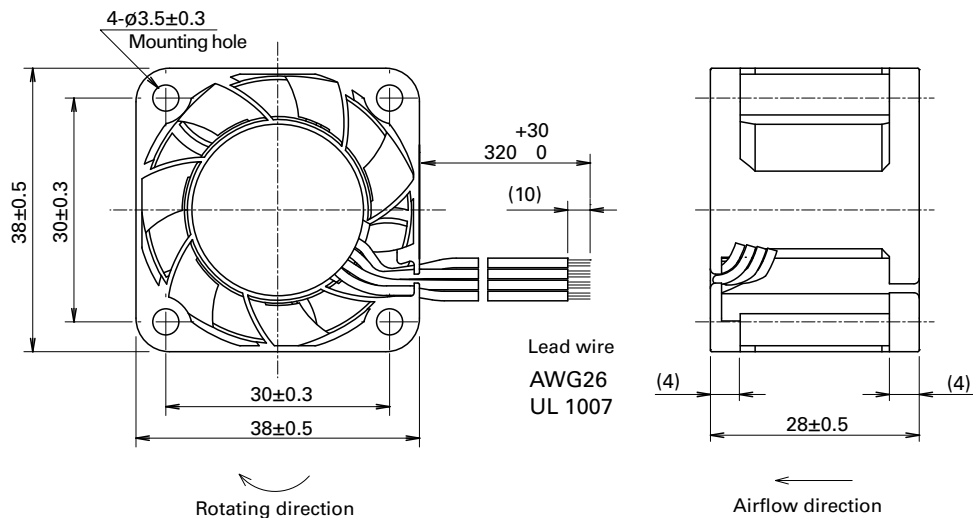

■ Reference Dimensions of Mounting Holes and Vent Opening (unit: mm)

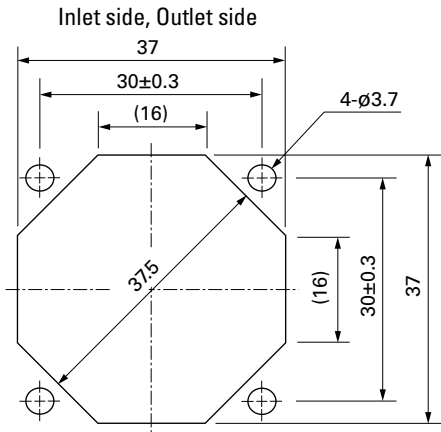

■ Options

Finger guards

page: p. 532

Model no.: 109-1065

Mouser Electronics

Authorized Distributor

Click to View Pricing, Inventory, Delivery & Lifecycle Information:

Sanyo Denki:

[9GA0312P3G001](#) [9GA0312P3J001](#) [9GA0312P3K001](#) [9GA0312P3G0011](#) [9GA0312P3K0011](#) [9GA0312P3J0011](#)
[9GA0312K3001](#) [9GA0312G3001](#) [9GA0312J3001](#) [9GA0312K3D0011](#) [9GA0312K3D001](#)