

REV	DATE	ECN NUMBER	ECR COMMENT
017	20 Feb 2019	C04140	Amend leg dimension 5mm to 5.5mm grid ref 3E
016	12 Sep 2018	C03988	BORDER UPDATED

AN INSULATED 4mm SOCKET, FOR DIRECT MOUNTING ONTO PRINTED CIRCUIT BOARDS. GROOVES IN THE OUTER ACETAL HOUSING PROVIDE STACKING ALIGNMENT FOR BOARD SPACE SAVING.

Ø9.5  
PANEL  
CUTOUT

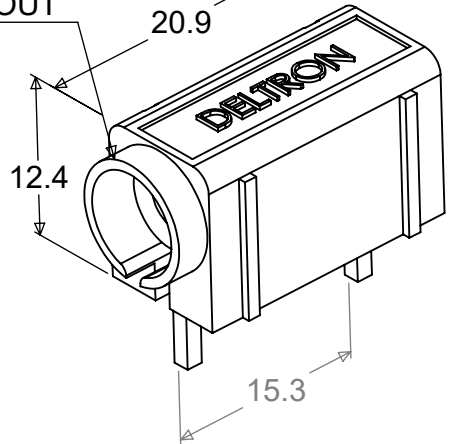

**DIMENSIONS**

23.3  
OVERALL  
LENGTH

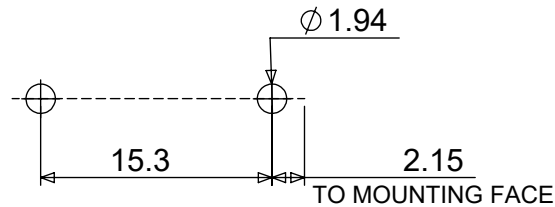
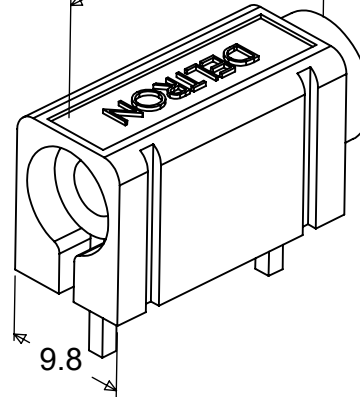

**PCB LAYOUT**

HOLE TO ACCEPT  
4mm PLUG  
Ø4.1

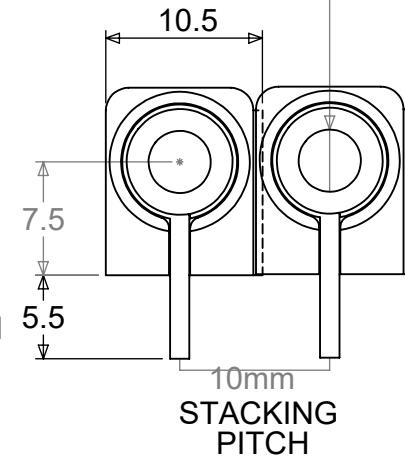

PCB PIN  
LENGTH

STACKING  
PITCH

<b>Insulant</b>	Acetal
<b>Pin</b>	Brass, Silver Plate
<b>Bush</b>	Brass, Silver Plate
<b>Amps</b>	10A
<b>Working Voltage</b>	50V
<b>Contact Resistance</b>	10mΩ
<b>Maximum Temperature RTI</b>	+ 110°C
<b>Minimum Temperature</b>	-25°C
<b>Recommended Temperature</b>	10A @ 55°C
<b>Voltage Breakdown</b>	5000V
<b>Recommended Conductor size</b>	1.5mm <sup>2</sup>
<b>Colours</b>	Order Code
Black	571-0100
Blue	571-0200
Brown	571-0300
Green	571-0400
Red	571-0500
White	571-0600
Yellow	571-0700

Component complies with 260° deg J-STD-075  
Non-IC Electronic Components Standard  
Met PSL W4

**90° PCB MOUNTED INSULATED SOCKET-SINGLE**



**PROPRIETARY AND CONFIDENTIAL:**

THE INFORMATION CONTAINED IN THIS DRAWING IS THE SOLE PROPERTY OF ALPHA 3 MANUFACTURING. ANY REPRODUCTION IN PART OR AS A WHOLE WITHOUT THE WRITTEN PERMISSION OF ALPHA 3 MANUFACTURING IS PROHIBITED.

DEM Manufacturing is a division of Alpha 3 Manufacturing LTD  
DEM Manufacturing, Deltron Emcon House, Hargreaves Way,  
Sawcliffe Ind. Park, Scunthorpe, North Lincolnshire, DN15 8RF, UK

UNLESS OTHERWISE SPECIFIED DIMENSIONS ARE IN MILLIMETRES  
LINEAR & RADIAL TOLERANCE:  
**NO DECIMAL PLACES**  
**1 DECIMAL PLACE**  
**2 DECIMAL PLACES**  
**ANGULAR TOLERANCE:**

**IF IN DOUBT ASK! DO NOT SCALE DRAWING!**

FINISH	SEE TABLE
MATERIAL	SEE TABLE
THE FINISHED PRODUCT SHOULD BE CLEAN AND FREE FROM ALL LIQUIDS AND DEBRIS. SURFACES SHOULD BE OF UNIFORM APPEARANCE FREE FROM SHARP EDGES, BURRS AND CORROSION	

AUTHOR	SB	TITLE	GENERAL SPECIFICATION
EDITOR	DT	FILE	571-SERIES
APPROVER	WC	PART	SINGLE 4mm PCB SOCKET
THIRD ANGLE PROJECTION	SHEET 1 OF 1	ISSUE/REV.	017
SCALE	2:1	A4	RELEASED
VERSION	19	EDIT DATE	20 Feb 2019

# Mouser Electronics

Authorized Distributor

Click to View Pricing, Inventory, Delivery & Lifecycle Information:

[Deltron:](#)

[571-0400](#)