

REV	DATE	ECN NUMBER	ECR COMMENT
017	20 Feb 2019	C04140	Amend leg dimension 5mm to 5.5mm grid ref 3E
016	12 Sep 2018	C03988	BORDER UPDATED

AN INSULATED 4mm SOCKET, FOR DIRECT MOUNTING ONTO PRINTED CIRCUIT BOARDS. GROOVES IN THE OUTER ACETAL HOUSING PROVIDE STACKING ALIGNMENT FOR BOARD SPACE SAVING.

Ø9.5
PANEL
CUTOUT

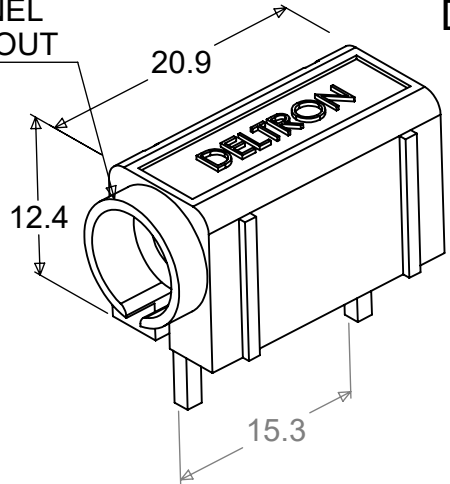

DIMENSIONS

23.3
OVERALL
LENGTH

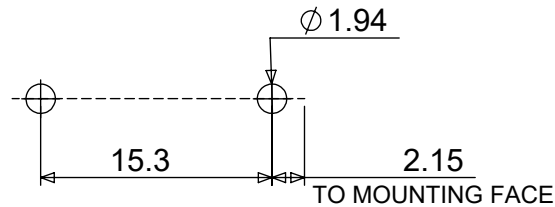
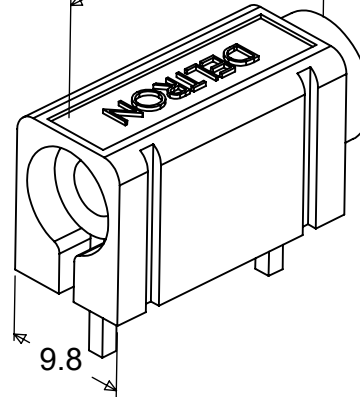

PCB LAYOUT

HOLE TO ACCEPT
4mm PLUG
Ø4.1

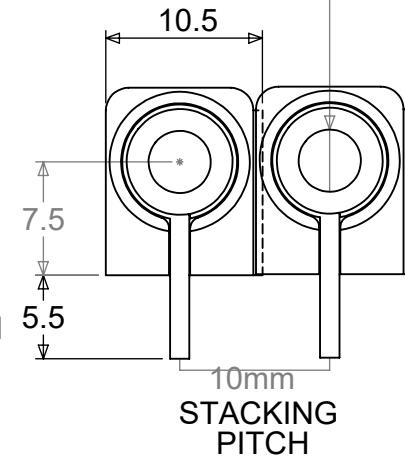

PCB PIN
LENGTH

STACKING
PITCH

Insulant	Acetal
Pin	Brass, Silver Plate
Bush	Brass, Silver Plate
Amps	10A
Working Voltage	50V
Contact Resistance	10mΩ
Maximum Temperature RTI	+ 110°C
Minimum Temperature	-25°C
Recommended Temperature	10A @ 55°C
Voltage Breakdown	5000V
Recommended Conductor size	1.5mm ²
Colours	Order Code
Black	571-0100
Blue	571-0200
Brown	571-0300
Green	571-0400
Red	571-0500
White	571-0600
Yellow	571-0700

Component complies with 260° deg J-STD-075
Non-IC Electronic Components Standard
Met PSL W4

90° PCB MOUNTED INSULATED SOCKET-SINGLE



PROPRIETARY AND CONFIDENTIAL:
THE INFORMATION CONTAINED IN THIS DRAWING IS THE SOLE PROPERTY OF ALPHA 3 MANUFACTURING. ANY REPRODUCTION IN PART OR AS A WHOLE WITHOUT THE WRITTEN PERMISSION OF ALPHA 3 MANUFACTURING IS PROHIBITED.
DEM Manufacturing is a division of Alpha 3 Manufacturing LTD
DEM Manufacturing, Deltron Emcon House, Hargreaves Way, Sawcliffe Ind. Park, Scunthorpe, North Lincolnshire, DN15 8RF, UK

UNLESS OTHERWISE SPECIFIED DIMENSIONS ARE IN MILLIMETRES
LINEAR & RADIAL TOLERANCE:
NO DECIMAL PLACES
1 DECIMAL PLACE
2 DECIMAL PLACES
ANGULAR TOLERANCE:

IF IN DOUBT ASK! DO NOT SCALE DRAWING!

FINISH	SEE TABLE
MATERIAL	SEE TABLE
THE FINISHED PRODUCT SHOULD BE CLEAN AND FREE FROM ALL LIQUIDS AND DEBRIS. SURFACES SHOULD BE OF UNIFORM APPEARANCE FREE FROM SHARP EDGES, BURRS AND CORROSION	

AUTHOR	SB	TITLE	GENERAL SPECIFICATION
EDITOR	DT	FILE	571-SERIES
APPROVER	WC	PART	SINGLE 4mm PCB SOCKET
THIRD ANGLE PROJECTION	SHEET 1 OF 1	ISSUE/REV.	017
SCALE 2:1	A4	RELEASED	VERSION 19
		EDIT DATE	20 Feb 2019

Mouser Electronics

Authorized Distributor

Click to View Pricing, Inventory, Delivery & Lifecycle Information:

[Deltron:](#)

[571-0100](#)