

Features:

- 4G/5G antenna
- Frequency 617-6000MHz
- Gain 0 / 2.5dBi
- Size 40 x 7 x 3 mm
- Fully SMT compatible
- Tape & Reel packing
- MSL-3

Applications:

- Broad band antenna, combines all sub 6GHz 4G and 5G bands
- Devices requiring high performance compact internal 4G/5G antenna
- Suitable for 2xMiMo use when mounting two pcs W3415 onto radio board

All dimensions are in mm / inches

Issue: 2042

In the effort to improve our products, we reserve the right to make changes judged to be necessary.

CONFIDENTIAL AND PROPRIETARY INFORMATION

This document contains confidential and proprietary information of Pulse Electronics, Inc. (Pulse) and is protected by copyright, trade secret and other state and federal laws. Its receipt or possession does not convey any rights to reproduce, disclose its contents, or to manufacture, use or sell anything it may describe. Reproduction, disclosure or use without specific written authorization of Pulse is strictly forbidden.

For more information:

Pulse Worldwide Headquarters
15255 Innovation Drive #100
San Diego, CA 92128
USA
Tel: 1-858-674-8100

Pulse/Larsen Antennas
18110 SE 34th St Bldg 2 Suite 250
Vancouver, WA 98683
USA
Tel: 1-360-944-7551

Europe Headquarters
Pulse GmbH & Do, KG
Zeppelinstrasse 15
Herrenberg, Germany
Tel: 49 7032 7806 0

Pulse (Suzhou) Wireless Products Co, Inc.
99 Huo Ju Road(#29 Bldg,4th Phase
Suzhou New District
Jiangsu Province, Suzhou 215009 PR China
Tel: 86 512 6807 9998



Description: 617-6000MHz SMD 4G/5G IoT Antenna**PART NUMBER:** W3415**ELECTRICAL SPECIFICATIONS**

Antenna Type	PCB
Frequency	617-960/1430-6000MHz
Nominal Impedance	50 Ω
Return Loss	<-4
Radiation Pattern	Omni
Gain 617~960MHz	-1 to 1dBi
Gain 1430~6000MHz	1 to 7 dBi
Efficiency 617~960MHz	>40% typical
Efficiency 1430-6000MHz	>45% typical
Polarization	Linear
Power Withstanding	2W

MECHANICAL SPECIFICATIONS

Color	Black
Size	40mm(L) * 7mm(W) * 3mm(T)
Weight	1.65 g
Fixing system	SMT
MSL (MOISTURE SENSITIVITY LEVEL)	3

ENVIRONMENTAL SPECIFICATIONS

Operating Temperature	-40 ~ +85° C
Storage Temperature	-40 ~ +85° C
RoHS Compliant	Yes

MECHANICAL DRAWING

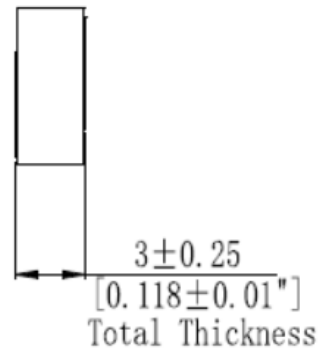
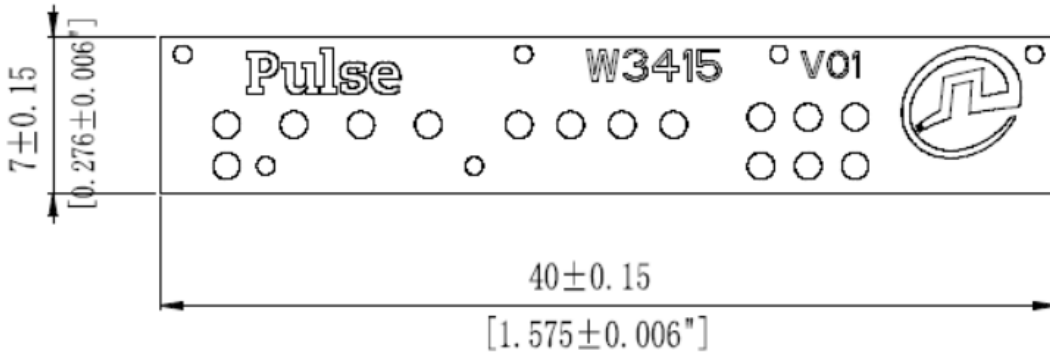

Front View

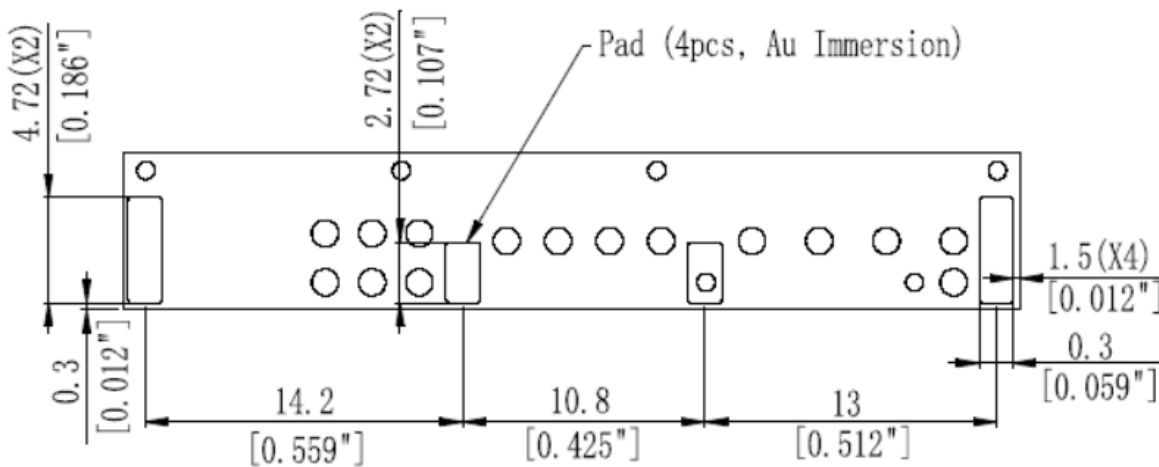

Back View

Unit: mm[in]

Recommendation for reflow soldering process

Printing stencil thickness 0,15 - 0,25 mm is recommended for the solder paste. The maximum soldering temperature should not exceed 260°C. The temperature profile recommendations for reflow soldering process is presented in the Figures 1 and 2. The reflow profile

presented in figure 1 describes minimum reflow temperatures. The reflow profile presented in figure 2 describes maximum reflow temperatures. located at the center of the coverage area.

	Method of heat transfer	Controlled hot air convection
1	Average temperature gradient in preheating	2.5 °C/s
2	Soak time	2-3 minutes
3	Max temperature gradient in reflow	3 °C/s
4	Time above 217 °C	Max 30 sec
5	Peak temperature in reflow	230 °C for 10 seconds
6	Temperature gradient in cooling	Max -5 °C/s

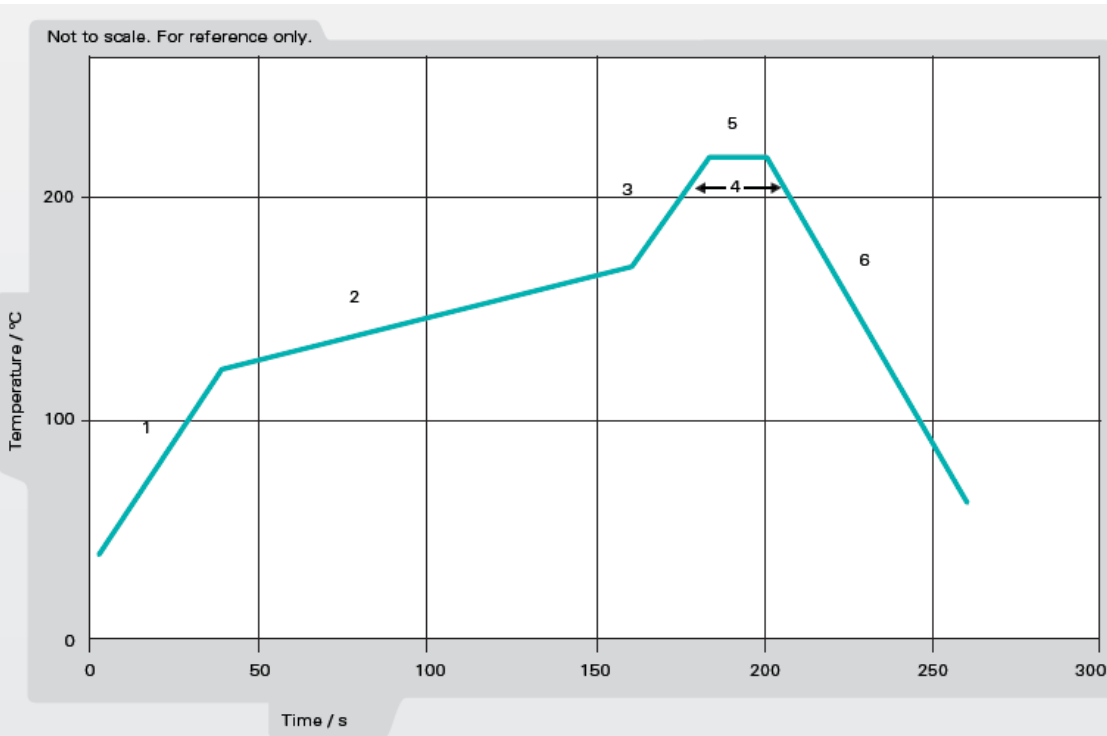
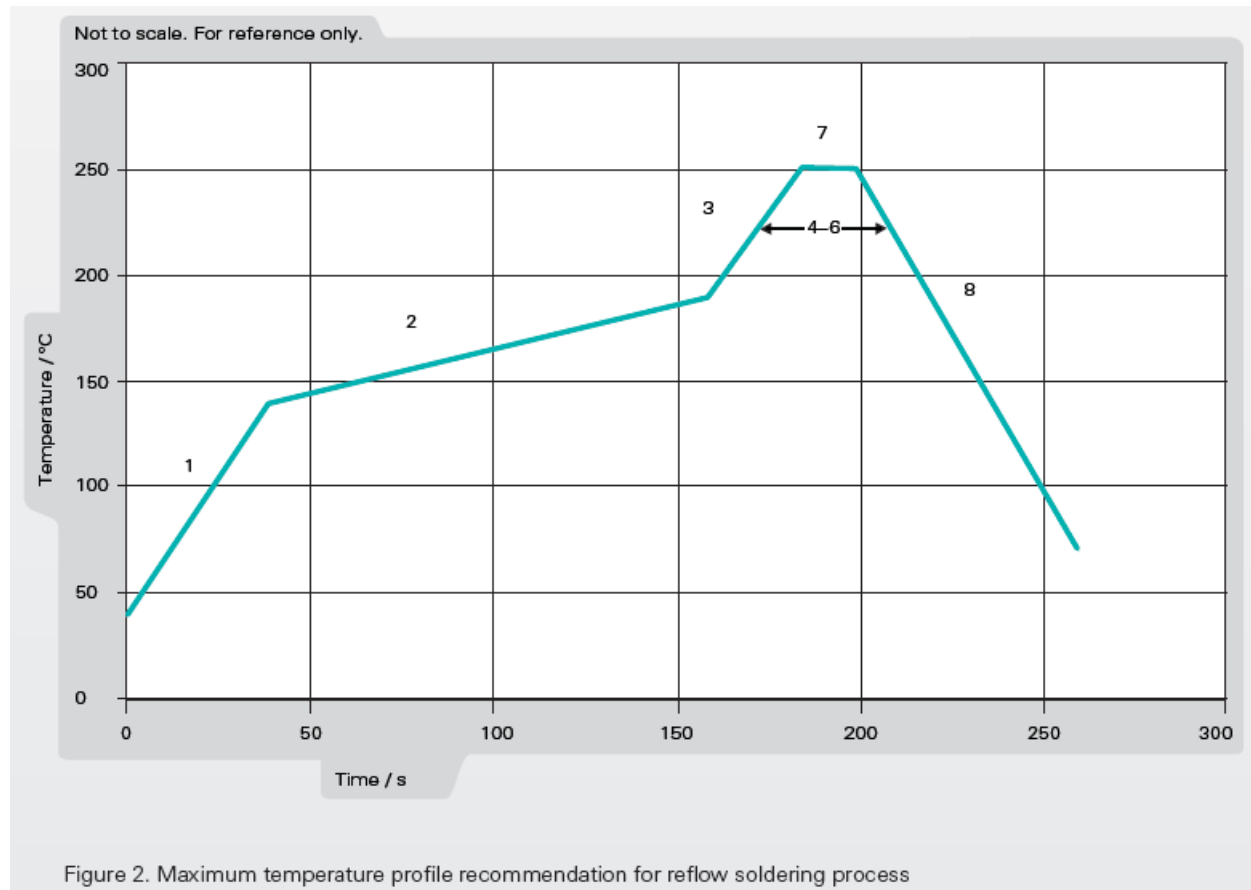

Figure 1. Minimum temperature profile recommendation for reflow soldering process

Recommendation for reflow soldering process

	Method of heat transfer	Controlled hot air convection
1	Average temperature gradient in preheating	2.5 °C/s
2	Soak time	2-3 minutes
3	Max temperature gradient in reflow	3 °C/s
4	Time above 217 °C	Max 60 sec
5	Time above 230 °C	Max 50 sec
6	Time above 250 °C	Max 10 sec
7	Peak temperature in reflow	260 °C for 5 seconds
8	Temperature gradient in cooling	Max -5 °C/s



TEST SETUP



TEST SETUP

Pulse reference test PCB for W3415 antenna

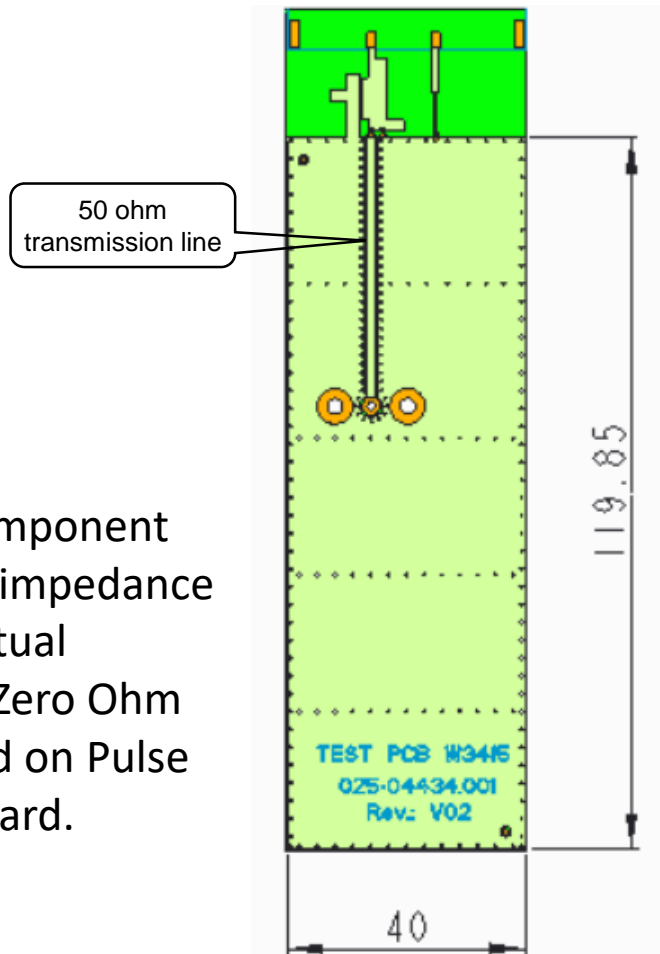

Matching component reserved for impedance tuning on actual application. Zero Ohm jumpers used on Pulse reference board.

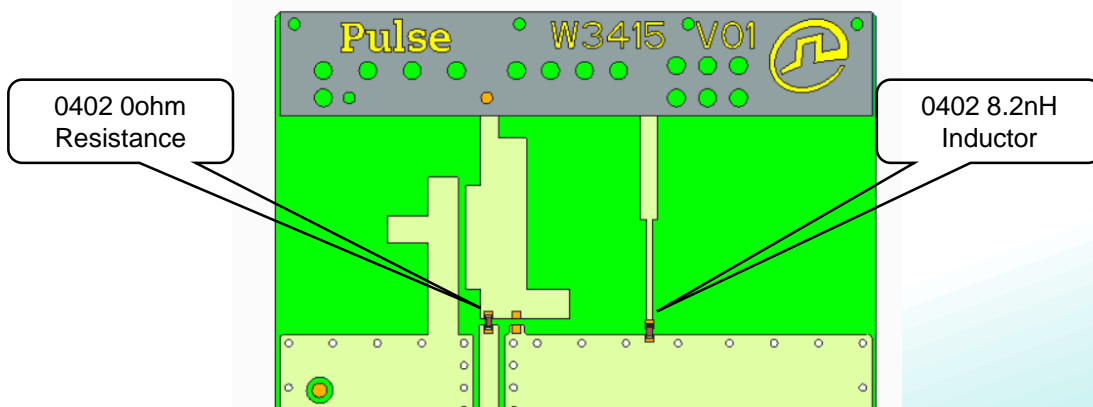

Issue: 2042

In the effort to improve our products, we reserve the right to make changes judged to be necessary.

CONFIDENTIAL AND PROPRIETARY INFORMATION

This document contains confidential and proprietary information of Pulse Electronics, Inc. (Pulse) and is protected by copyright, trade secret and other state and federal laws. Its receipt or possession does not convey any rights to reproduce, disclose its contents, or to manufacture, use or sell anything it may describe. Reproduction, disclosure or use without specific written authorization of Pulse is strictly forbidden.

TEST SETUP

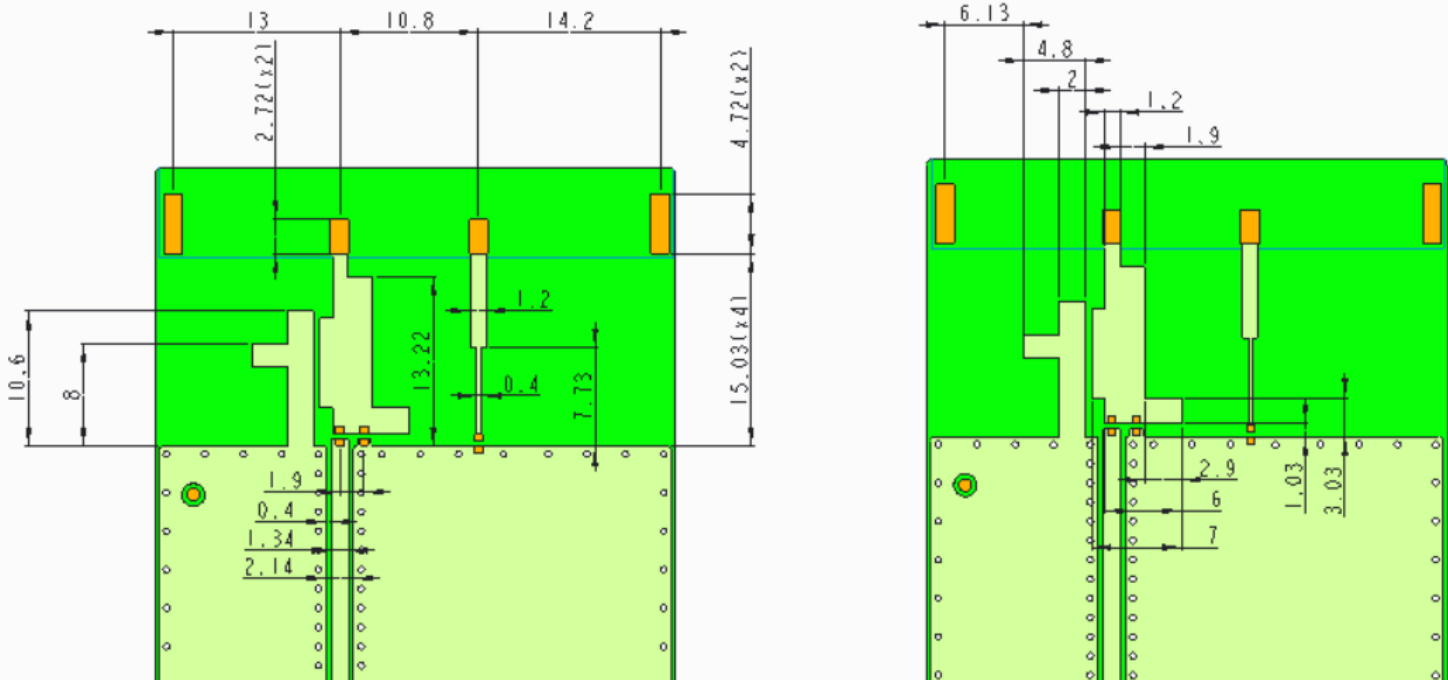

Recommended test board PCB layout for electrical characteristic measurement.

Substrate material: ISOLA 185HR.

Total thickness: 1mm

All dimensions are in mm

Issue: 2042

In the effort to improve our products, we reserve the right to make changes judged to be necessary.

CONFIDENTIAL AND PROPRIETARY INFORMATION

This document contains confidential and proprietary information of Pulse Electronics, Inc. (Pulse) and is protected by copyright, trade secret and other state and federal laws. Its receipt or possession does not convey any rights to reproduce, disclose its contents, or to manufacture, use or sell anything it may describe. Reproduction, disclosure or use without specific written authorization of Pulse is strictly forbidden.

CHARTS

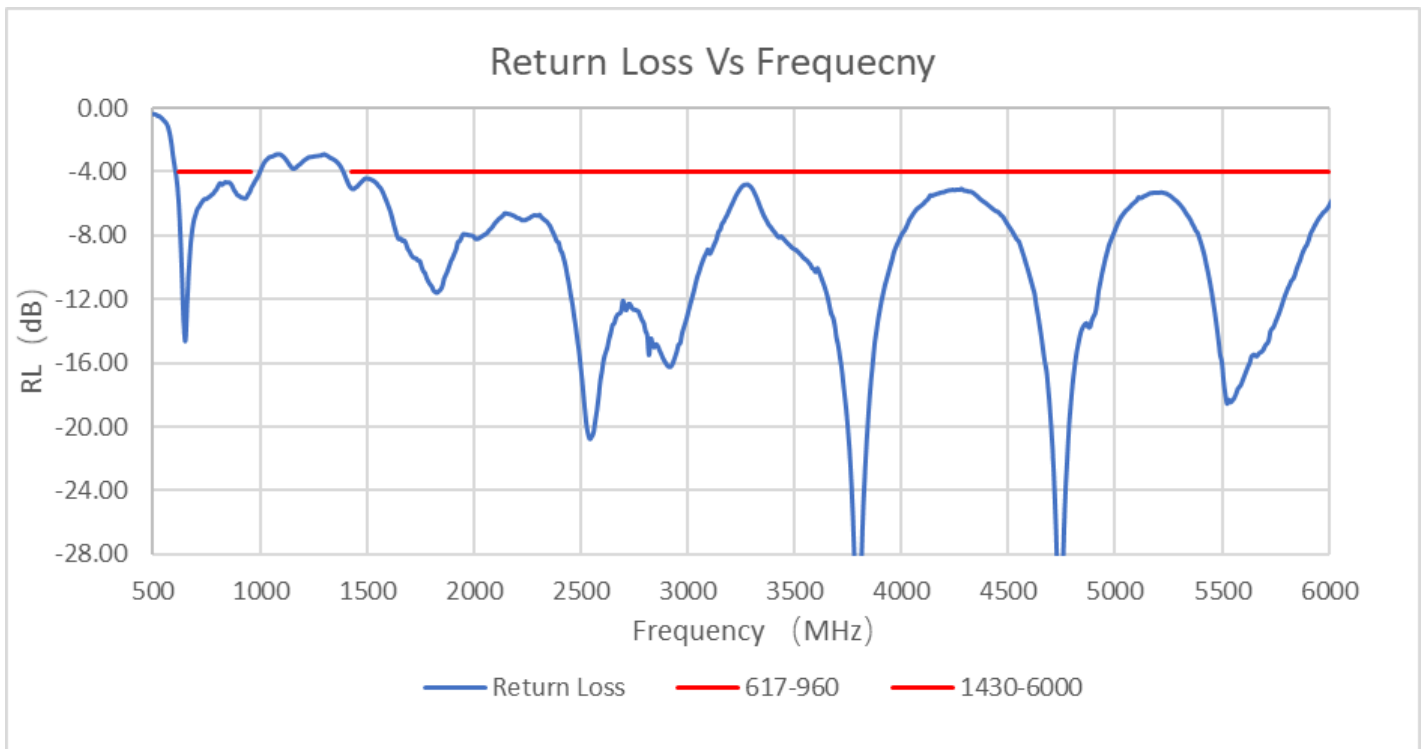

CHARTS

Gain(dBi)

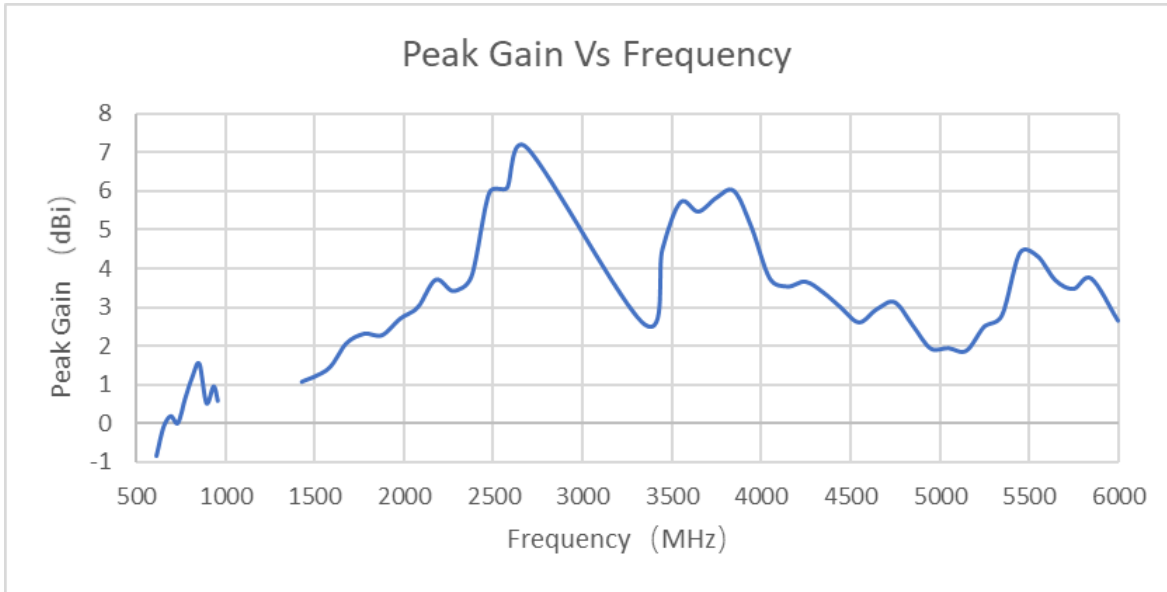

Efficiency(%)

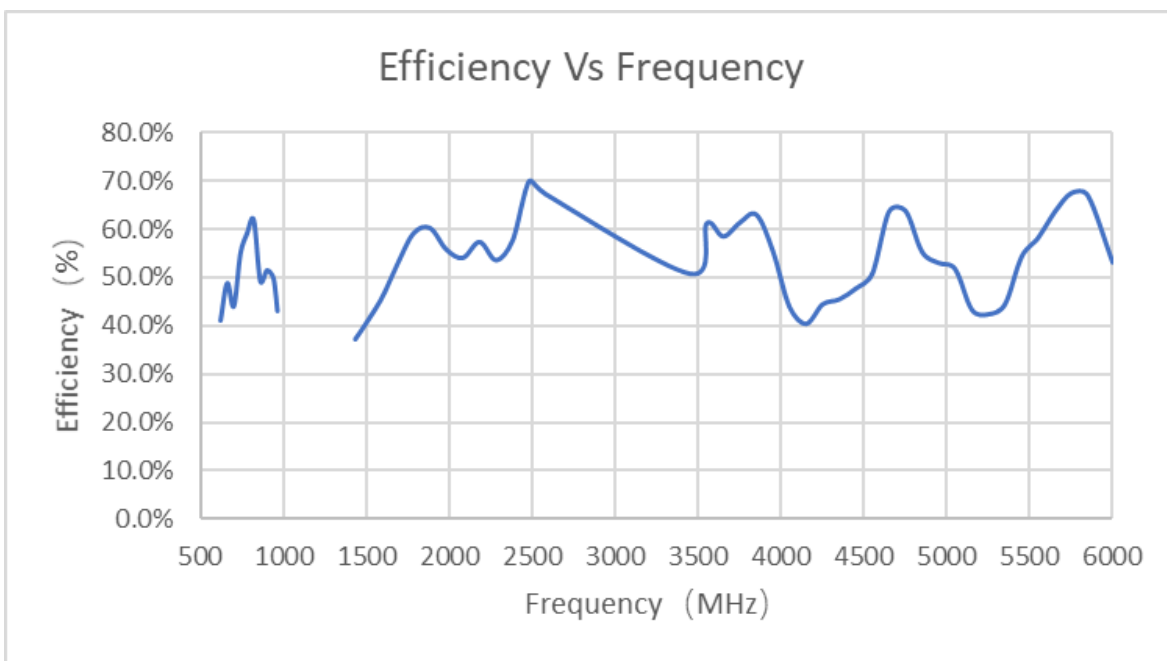

Issue: 2042

In the effort to improve our products, we reserve the right to make changes judged to be necessary.

CONFIDENTIAL AND PROPRIETARY INFORMATION

This document contains confidential and proprietary information of Pulse Electronics, Inc. (Pulse) and is protected by copyright, trade secret and other state and federal laws. Its receipt or possession does not convey any rights to reproduce, disclose its contents, or to manufacture, use or sell anything it may describe. Reproduction, disclosure or use without specific written authorization of Pulse is strictly forbidden.

CHARTS

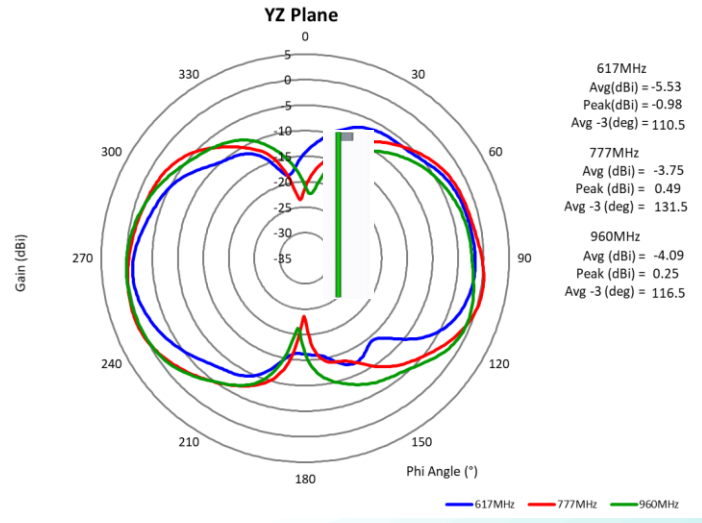
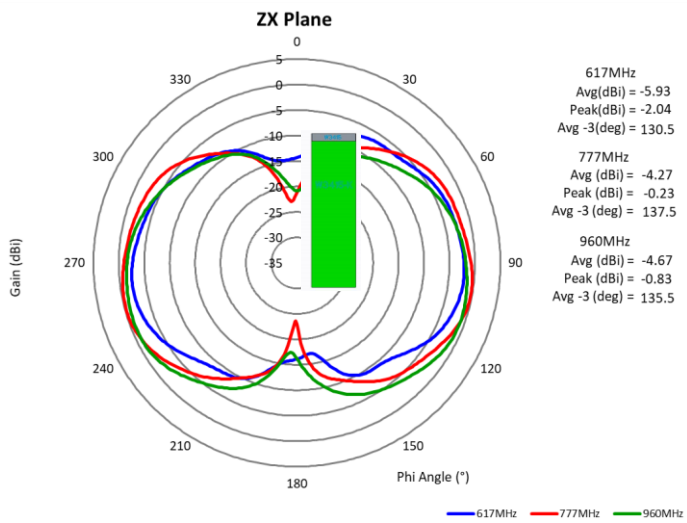
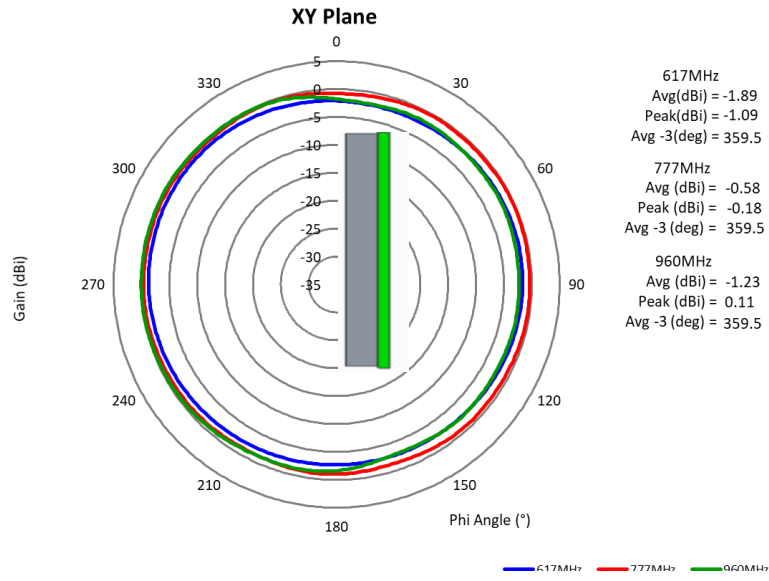

Issue: 2042

In the effort to improve our products, we reserve the right to make changes judged to be necessary.

CONFIDENTIAL AND PROPRIETARY INFORMATION

This document contains confidential and proprietary information of Pulse Electronics, Inc. (Pulse) and is protected by copyright, trade secret and other state and federal laws. Its receipt or possession does not convey any rights to reproduce, disclose its contents, or to manufacture, use or sell anything it may describe. Reproduction, disclosure or use without specific written authorization of Pulse is strictly forbidden.

CHARTS

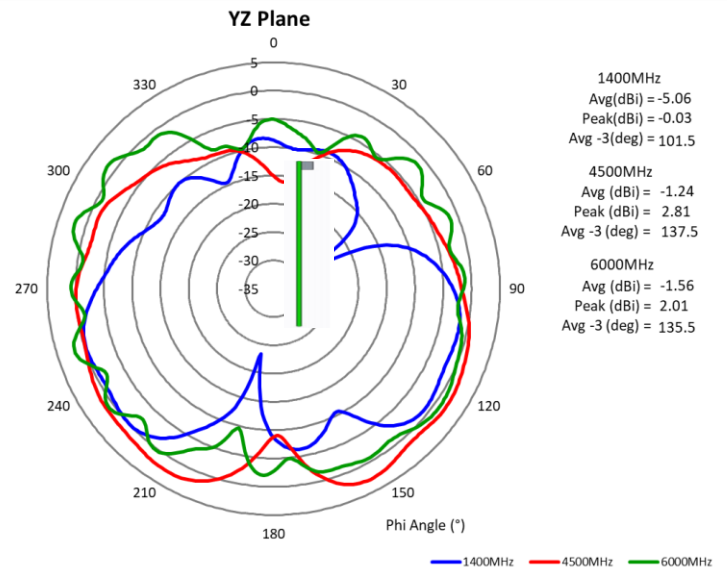
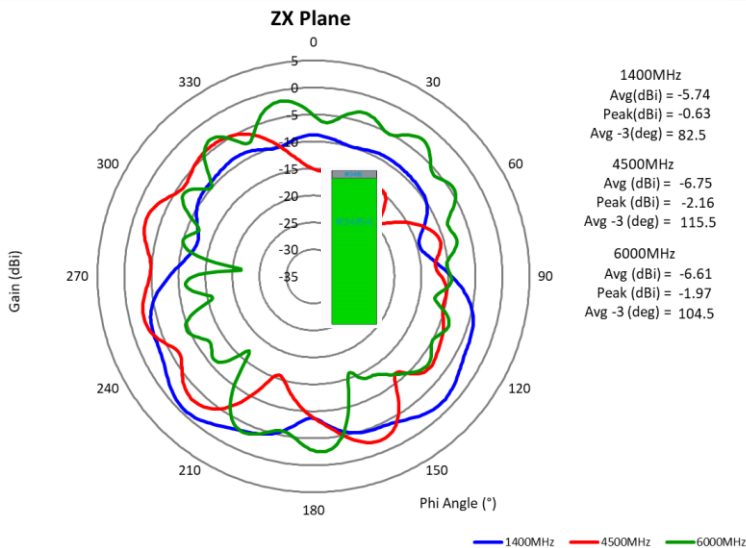
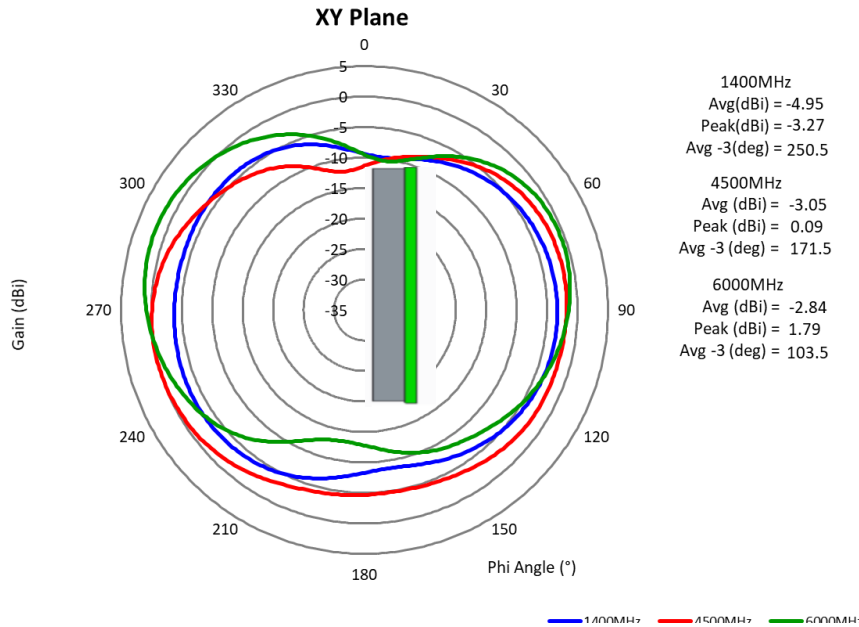

Issue: 2042

In the effort to improve our products, we reserve the right to make changes judged to be necessary.

CONFIDENTIAL AND PROPRIETARY INFORMATION

This document contains confidential and proprietary information of Pulse Electronics, Inc. (Pulse) and is protected by copyright, trade secret and other state and federal laws. Its receipt or possession does not convey any rights to reproduce, disclose its contents, or to manufacture, use or sell anything it may describe. Reproduction, disclosure or use without specific written authorization of Pulse is strictly forbidden.

PCB length effect

100 mm

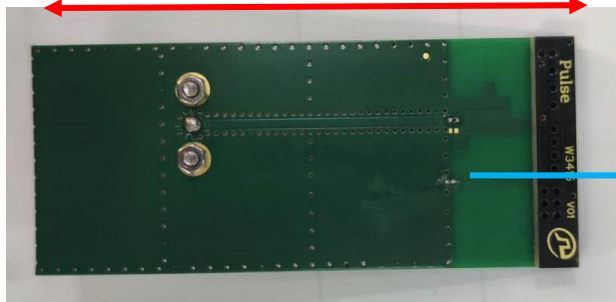

6.8nH

120 mm

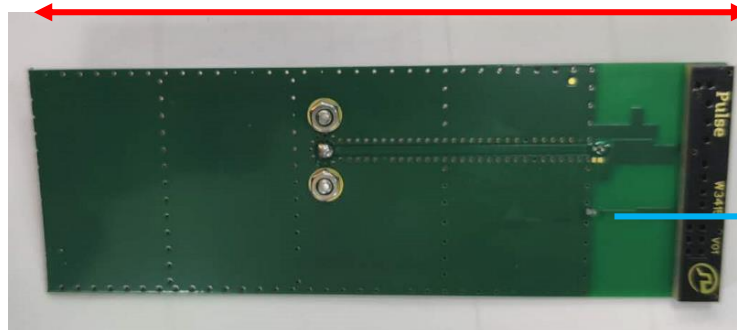

7.5nH

140 mm

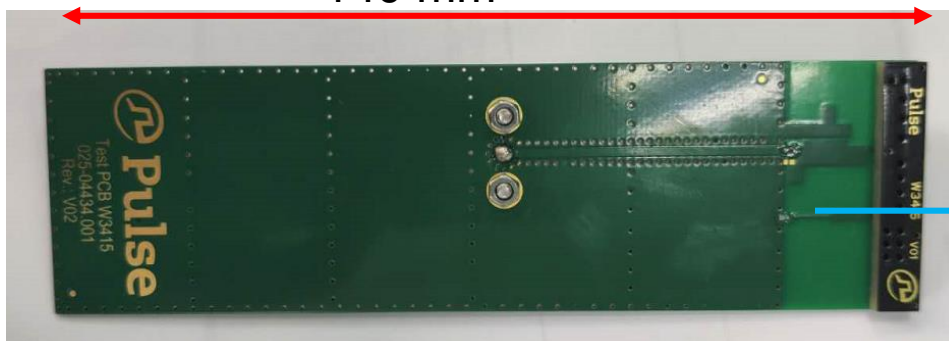

8.2nH

PCB length effect

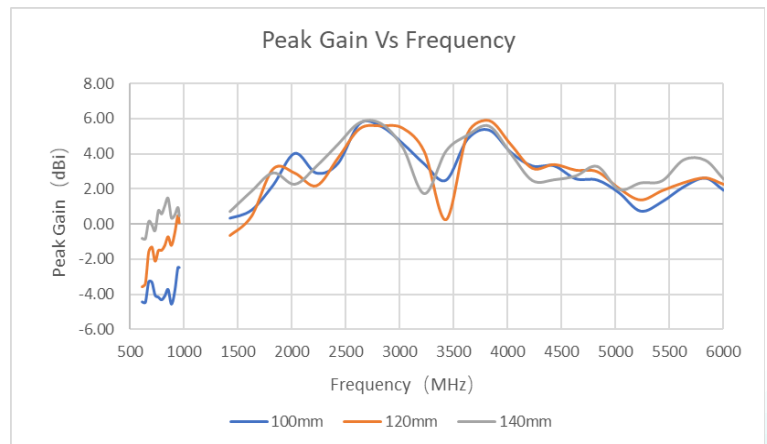
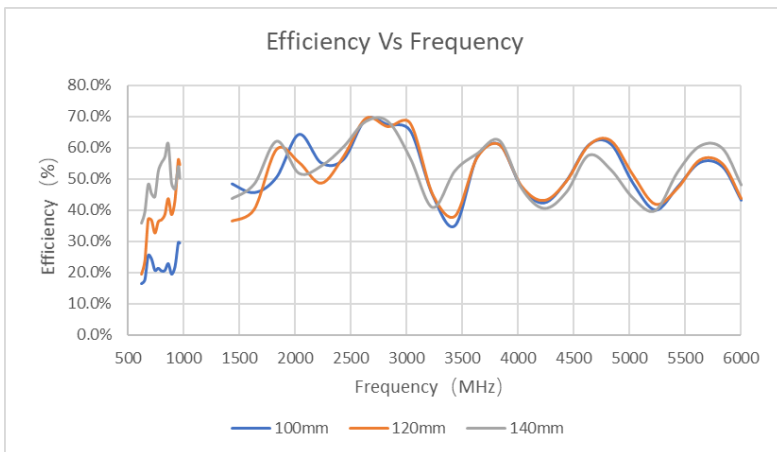
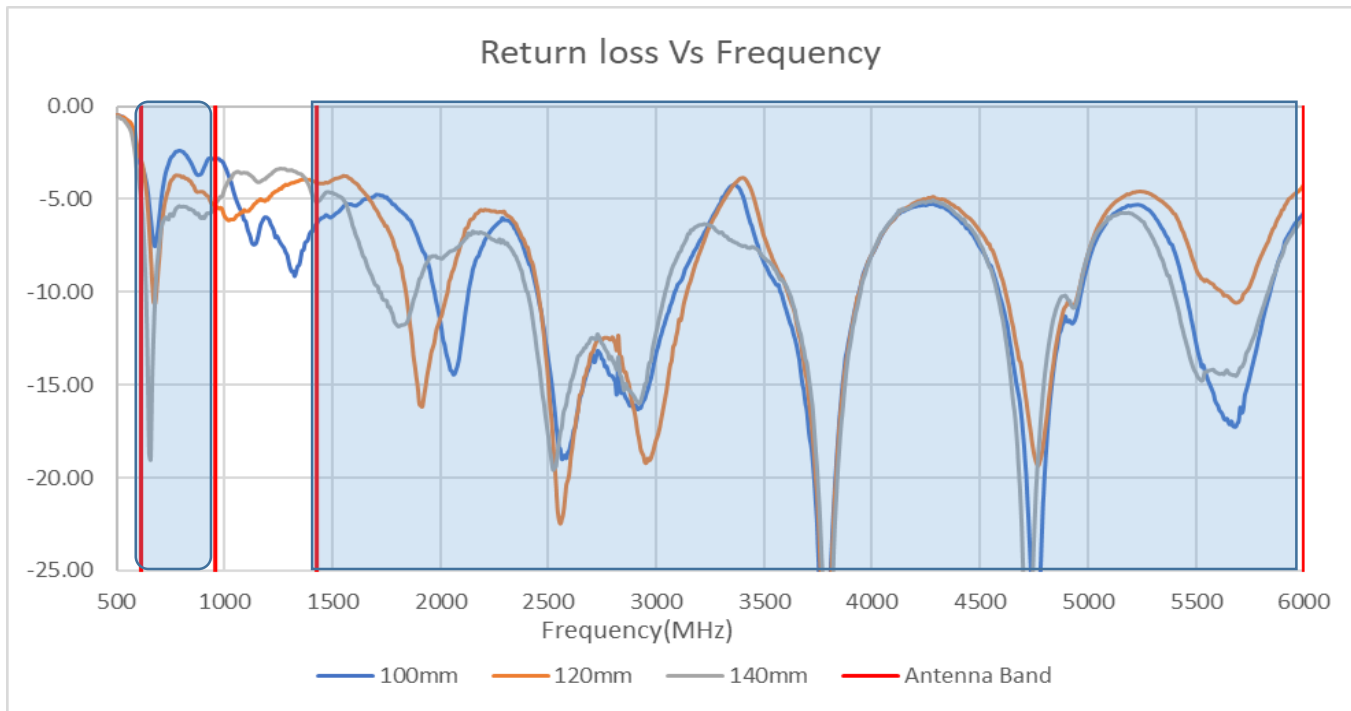

PACKAGING

1000pcs Antennas Per 1pcs 13" Tape & Reel
 2 pcs 13" Tape & Reel (total 2000pcs Antennas) per 1 box

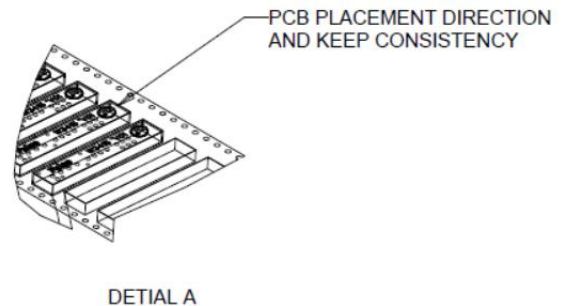
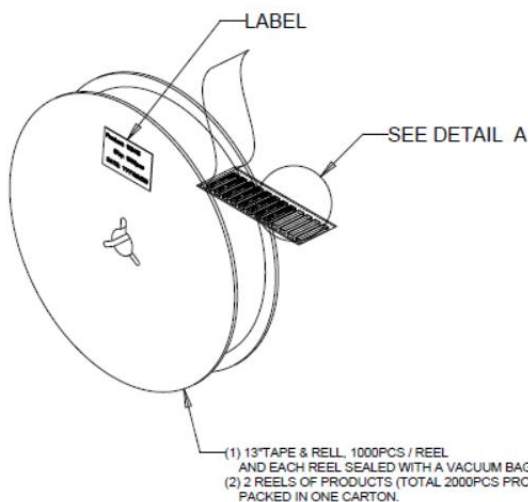
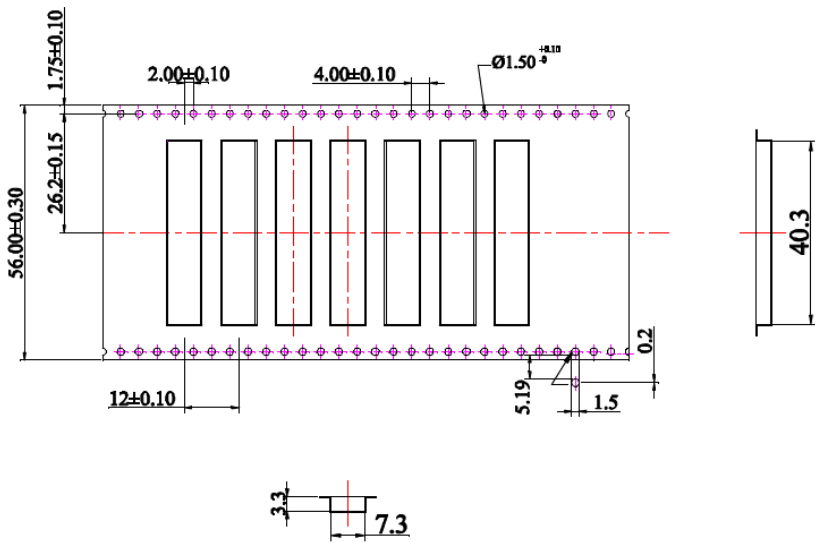

(1) 13" TAPE & REEL, 1000PCS / REEL
 AND EACH REEL SEALED WITH A VACUUM BAG (075-03363.001)
 (2) 2 REELS OF PRODUCTS (TOTAL 2000PCS PRODUCTS)
 PACKED IN ONE CARTON.

Mouser Electronics

Authorized Distributor

Click to View Pricing, Inventory, Delivery & Lifecycle Information:

Pulse:

W3415