

Dimensions: [mm]

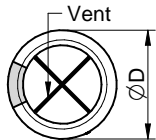

Properties		Value	Unit	Tol.
Diameter	Ø D	10	mm	±0.5
Length	L	12.5	mm	±1.5
Pitch	P	5	mm	±0.5
Pin Diameter	Ø F	0.6	mm	±0.02
Pitch	p	5	mm	±0.5
Hole Diameter	Ø f	0.9	mm	±0.02

Recommended Hole Pattern: [mm]

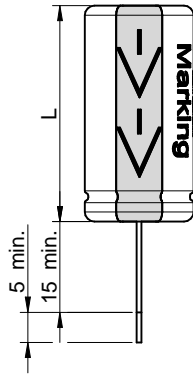
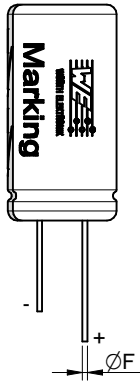
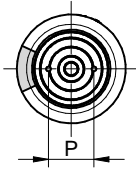
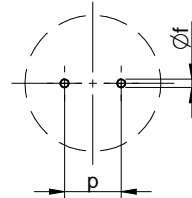

Schematic:

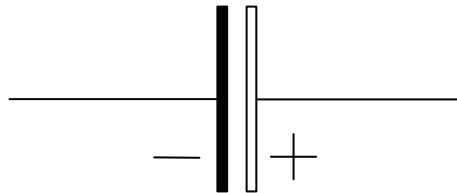

Electrical Properties:

Properties		Test conditions	Value	Unit	Tol.
Capacitance	C	0.25 V/ 120 Hz/ +20 °C	6.8	µF	±20%
Rated Voltage	V _R		400	V (DC)	max.
Surge Voltage	V _S	1000 cycles @ 105 °C	440	V (DC)	max.
Leakage Current	I _{Leak}	1 min./ +20 °C	208.8	µA	max.
Dissipation Factor	DF	0.25 V/ 120 Hz/ +20 °C	20	%	max.
Ripple Current	I _{RIPPLE}	100 kHz @ 105 °C	220	mA	max.

General Information:

Aluminum Electrolytic Capacitors	
Operating Temperature	-25 up to +105 °C
Storage Conditions (in original packaging)	5 °C - 35 °C; 10 % up to 75 % RH
Endurance	10000 h
Moisture Sensitivity Level (MSL)	1
Test conditions of Electrical Properties: +20 °C, 35 % RH if not specified differently	
FIT according to separate documentation	
Surge Voltage: Charging time 30s, discharging time 330s for a cycle	
Component conform to REACH and RoHS requirements and standards	



Würth Elektronik eiSos GmbH & Co. KG
EMC & Inductive Solutions
Max-Eyth-Str. 1
74638 Waldenburg
Germany
Tel. +49 (0) 79 42 945 - 0
www.we-online.com
eiSos@we-online.com

CHECKED	REVISION	DATE (YYYY-MM-DD)	GENERAL TOLERANCE	PROJECTION METHOD
PSL	001.001	2019-06-05	DIN ISO 2768-1m	
DESCRIPTION			TECHNICAL REFERENCE	
WCAP-AT1H Aluminum Electrolytic Capacitors			ATJF1256R8M400DSPA9K000	
ORDER CODE			860241375001	
SIZE/TYPE	BUSINESS UNIT	STATUS	PAGE	
10.0 x 12.5	eiCap	Valid	1/9	

Product Marking:

1 st Line	Capacitance Value: 6.8 μ F & Rated Voltage: 400 V (DC) .
2 nd Line	WCAP-AT1H
3 rd Line	max. Operating Temperature +105 °C & Date Code: YWW

Multiplier for Ripple Current vs. Frequency



Frequency [Hz]	120	1K	10K	\geq 100K
Multiplier	0.50	0.80	0.85	1.0

Lifetime Performance:

Test Conditions	Endurance	Shelf Life
Lifetime	10000h, @ 105°C	1000h, @ 105°C
Voltage	U_R applied	None
Current	I_R	None
ΔC	$\leq \pm 20\%$ of initial measured value	$\leq \pm 20\%$ of initial measured value
DF	$\leq 200\%$ of the initial specified value	$\leq 200\%$ of the initial specified value
Leakage Current	\leq the initial specified value	\leq the initial specified value
Comment	Pre-treatment for measurements shall be conducted after application of DC working voltage for 30 min.	

Certification:

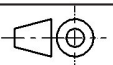
RoHS Approval	Compliant [2011/65/EU&2015/863]
REACH Approval	Conform or declared [(EC)1907/2006]
Halogen Free	Conform [JEDEC JS709B]
Halogen Free	Conform [IEC 61249-2-21]

	CHECKED PSL	REVISION 001.001	DATE (YYYY-MM-DD) 2019-06-05	GENERAL TOLERANCE DIN ISO 2768-1m	PROJECTION METHOD 
	DESCRIPTION WCAP-AT1H Aluminum Electrolytic Capacitors			TECHNICAL REFERENCE ATJF1256R8M400DSPA9K000	
	Würth Elektronik eiSos GmbH & Co. KG EMC & Inductive Solutions Max-Eyth-Str. 1 74638 Waldenburg Germany Tel. +49 (0) 79 42 945 - 0 www.we-online.com eiSos@we-online.com			ORDER CODE 860241375001	
	SIZE/TYPE 10.0 x 12.5	BUSINESS UNIT eiCap	STATUS Valid	PAGE 2/9	

Packaging Specification - Ammopack: [mm]

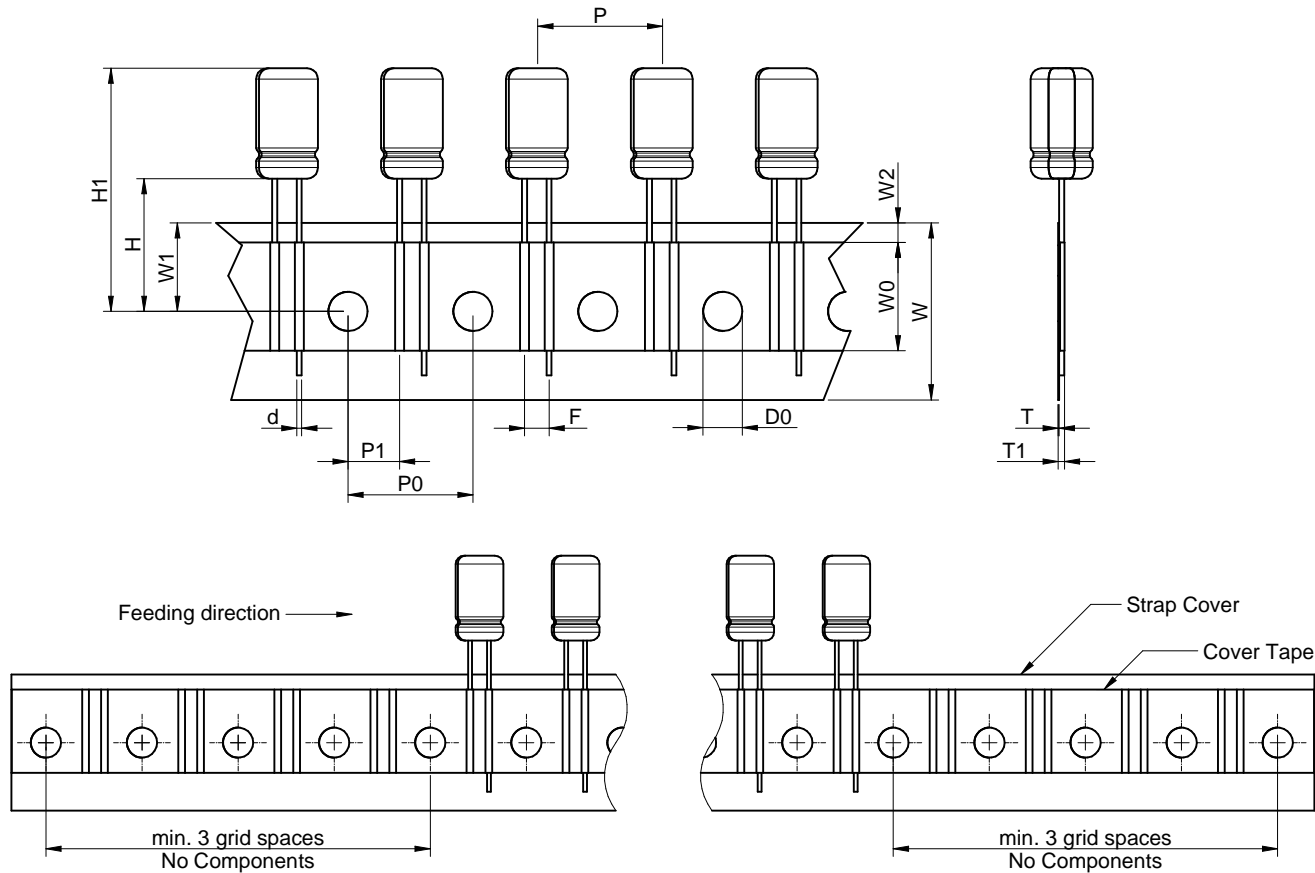

Packaging is referred to the international standard IEC 60286-2

	P	P0	P1	F	H	H1	d	T	T1 = d + T	W	W0	W1	W2	D0	Tape type 1
tolerance	±1,0	±0,3	±0,7	+0,5/ -0,2	±0,5	±0,5	±0,02	max.	max.	+1,0/ -0,5	+0,75/ -0,5	+0,75/ -0,5	max.	±0,2	
value	12,70	12,70	3,85	5,00	18,50	31,00	0,60	0,90	1,50	18,00	11,00	9,00	2,00	4,00	Paper

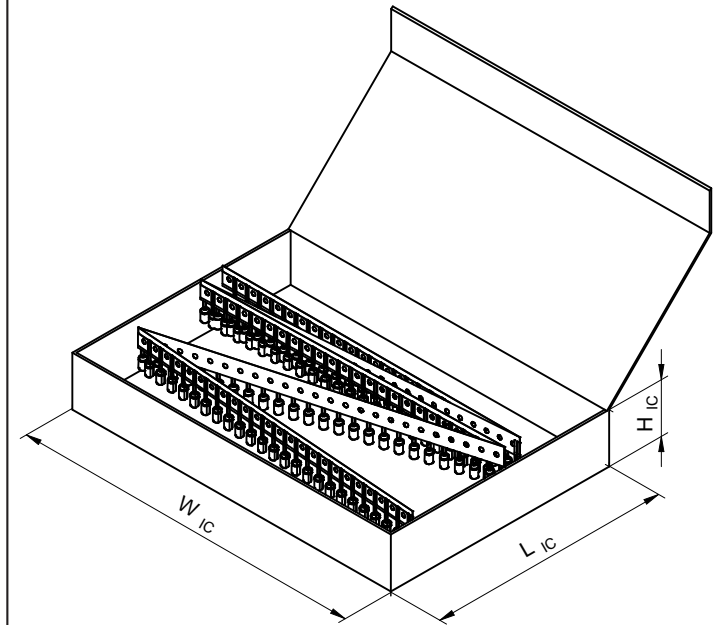

L _{IC} (mm)	W _{IC} (mm)	H _{IC} (mm)	Packaging Unit	Material
typ.	typ.	typ.	PCS.	
331	227	51	600	Paper



Würth Elektronik eiSos GmbH & Co. KG
EMC & Inductive Solutions
Max-Eyth-Str. 1
74638 Waldenburg
Germany
Tel. +49 (0) 79 42 945 - 0
www.we-online.com
eiSos@we-online.com

CHECKED	REVISION	DATE (YYYY-MM-DD)	GENERAL TOLERANCE	PROJECTION METHOD
PSL	001.001	2019-06-05	DIN ISO 2768-1m	
DESCRIPTION			TECHNICAL REFERENCE	
WCAP-AT1H Aluminum Electrolytic Capacitors			ATJF1256R8M400DSPA9K000	
ORDER CODE			860241375001	
SIZE/TYPE	BUSINESS UNIT	STATUS	PAGE	
10.0 x 12.5	eiCap	Valid	3/9	

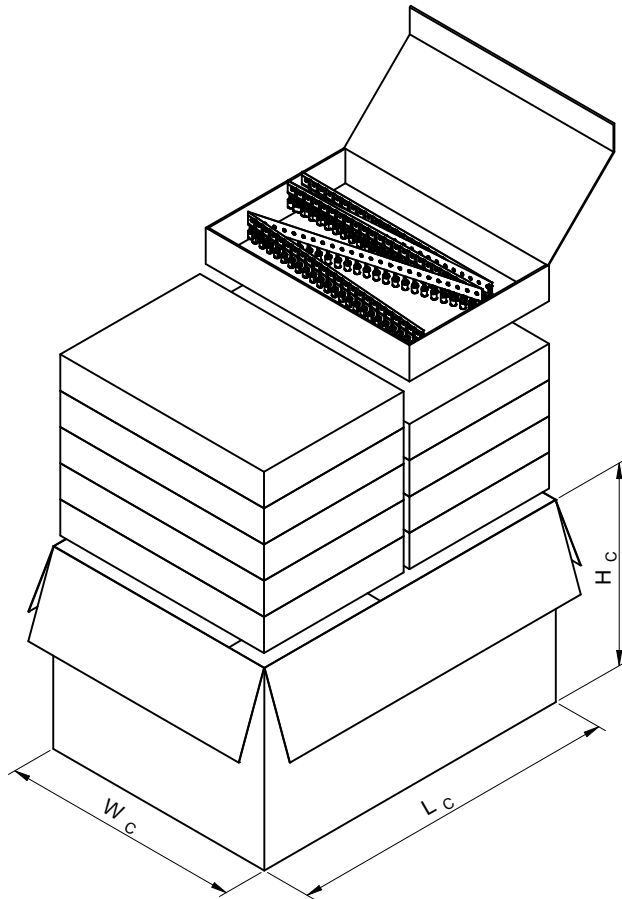

L _c (mm)	W _c (mm)	H _c (mm)	No. of inner carton	Packaging Unit	Material
typ.	typ.	typ.	pcs.	pcs.	
474	343	277	10	6000	Paper

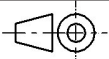

Würth Elektronik eiSos GmbH & Co. KG
 EMC & Inductive Solutions
 Max-Eyth-Str. 1
 74638 Waldenburg
 Germany
 Tel. +49 (0) 79 42 945 - 0
 www.we-online.com
 eiSos@we-online.com

CHECKED PSL	REVISION 001.001	DATE (YYYY-MM-DD) 2019-06-05	GENERAL TOLERANCE DIN ISO 2768-1m	PROJECTION METHOD 
DESCRIPTION WCAP-AT1H Aluminum Electrolytic Capacitors			TECHNICAL REFERENCE ATJF1256R8M400DSPA9K000	
SIZE/TYPE 10.0 x 12.5			ORDER CODE 860241375001	
BUSINESS UNIT eiCap		STATUS Valid		PAGE 4/9

Classification Wave Soldering Profile:



Classification Wave Soldering Profile:

Profile Feature		Pb-Free Assembly	Sn-Pb Assembly
Preheat Temperature Min	$T_{s \min}$	100 °C	100 °C
Preheat Temperature Typical	$T_{s \text{ typical}}$	120 °C	120 °C
Preheat Temperature Max	$T_{s \max}$	130 °C	130 °C
Preheat Time t_s from $T_{s \min}$ to $T_{s \max}$	t_s	70 seconds	70 seconds
Ramp-up Rate	ΔT	150 °C max.	150 °C max.
Peak Temperature	T_p	250 °C - 260 °C	235 °C - 260 °C
Time of actual peak temperature	t_p	max. 10 seconds max. 5 seconds each wave	max. 10 seconds max. 5 seconds each wave
Ramp-down Rate, Min		~ 2 K/ second	~ 2 K/ second
Ramp-down Rate, Typical		~ 3.5 K/ second	~ 3.5 K/ second
Ramp-down Rate, Max		~ 5 K/ second	~ 5 K/ second
Time 25 °C to 25 °C		4 minutes	4 minutes

refer to EN61760-1:2006

	CHECKED	REVISION	DATE (YYYY-MM-DD)	GENERAL TOLERANCE	PROJECTION METHOD
	PSL	001.001	2019-06-05	DIN ISO 2768-1m	
	DESCRIPTION			TECHNICAL REFERENCE	
	WCAP-AT1H Aluminum Electrolytic Capacitors			ATJF1256R8M400DSPA9K000	
Würth Elektronik eiSos GmbH & Co. KG EMC & Inductive Solutions Max-Eyth-Str. 1 74638 Waldenburg Germany Tel. +49 (0) 79 42 945 - 0 www.we-online.com eiSos@we-online.com	ORDER CODE				
	860241375001				
SIZE/TYPE	BUSINESS UNIT	STATUS	PAGE		
10.0 x 12.5	eiCap	Valid	5/9		

Cautions and Warnings:

The following conditions apply to all goods within the product series of WCAP-AT1H of Würth Elektronik eiSos GmbH & Co. KG:

1.01 Polarity

An Aluminum Electrolytic Capacitor has a polarity. In operation this polarity needs to be considered and adhered.

Reverse voltage can damage or destroy an Aluminum Electrolytic Capacitor. This can finally lead to a malfunction.

If the polarity in a circuit will be switched or possibly can be reversed, the usage of a non-polar capacitor shall be applied.

The polarity of an Aluminum Electrolytic Capacitor is for THT radial types marked like following.

The terminal with shorter lead wire marks the negative terminal. On the sleeve the negative terminal is marked with a color band and thereon are minus signs given. For further details see technical drawing on A1 dimensions in this datasheet.

1.02 Overvoltage

Avoid any overvoltage and do not apply a continuous overvoltage. If an overvoltage is applied to the capacitor, the leakage current can increase drastically. The applied working voltage is not allowed to exceed the rated working voltage of the specific capacitor.

1.03 Operating Temperature

The capacitor shall not be operated above the operating temperature, which is stated within this datasheet of the specific capacitor. The achievable lifetime of the capacitor is correlating to the applied temperature. In order to achieve the maximum lifetime, the capacitor should be operated by the lowest possible temperature conditions within the application.

1.04 Ripple Current

The applied ripple current shall not exceed the specified maximum ripple current of the capacitor.

If a higher ripple current is applied as permitted, it can cause excessive heat generation and higher temperature inside the capacitor. This happens due to pole change effects, if ripple current is applied to the capacitor. This can result in damage or lifetime shortage of the capacitor and may cause deterioration.

Electrolytic capacitors are regularly not designed for usage in AC applications and ripple current is applied / based due to parasitic effects on DC signal.

Please see electrical specification within this datasheet for maximum allowed ripple current.

1.05 Charge and Discharge

Frequent and quick charge / discharge cycles may generate heat inside the capacitor. In worst case this can cause a decrease of capacitance, an increase of leakage current or breakdown.

Applications with rapid charge and discharge cycles should be avoided. For assistance with your application please consult our technical support.

1.06 Vent

On most Aluminum Electrolytic Types types, a predetermined breaking point is given on the top of the component, which is the so called vent. The vent is there to assure a possible pressure relief and to avoid that the capacitor can explode due to internal pressure, which can occur by applying reverse voltage or a too high ripple current.

A space of at least 3mm above the vent is recommended, in order to assure the full function of the vent. If less space is present the vent maybe cannot operate correctly / completely.

1.07 Sleeve

The sleeve material consists of PET (polyethylene terephthalate). If excessive heat is applied to the sleeve (e.g. soldering process, etc.) the sleeve may crack or deform.

If the capacitor will be exposed to xylene, toluene or likewise and will be afterwards heated, the sleeve may crack or deform.

The sleeve does not assure any electrical insulation. It is to avoid to use / place the product on a spot where electrical insulation is needed. To assure electrical insulation, especially to the case of capacitor, further actions need to be taken.



1.08 Storage Conditions

The storage conditions for a capacitor are recommended to be 5 °C up to 35 °C and less than 75 % rel. humidity.

Do not expose the capacitor to environments with hazardous gas, ozone, ultraviolet rays or any kind of radiation. Avoid any contact of the capacitor with direct sunshine, saltwater, spray of water or types of oil during storage.

If a capacitor is stored for a long time without applying voltage or storage conditions of 35 °C or above and more than 75 % relative humidity, the leakage current may increase.

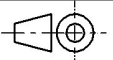
The leakage current will return to normal level when applying the rated voltage to the capacitor before use. If the capacitor was stored for more than 6 months, it is recommended to apply DC working voltage to the capacitor for 30 minutes through a 1 kΩ protective series resistor.

	CHECKED	REVISION	DATE (YYYY-MM-DD)	GENERAL TOLERANCE	PROJECTION METHOD	
	PSL	001.001	2019-06-05	DIN ISO 2768-1m		
	WÜRTH ELEKTRONIK eiSos GmbH & Co. KG EMC & Inductive Solutions Max-Eyth-Str. 1 74638 Waldenburg Germany Tel. +49 (0) 79 42 945 - 0 www.we-online.com eiSos@we-online.com			DESCRIPTION WCAP-AT1H Aluminum Electrolytic Capacitors		TECHNICAL REFERENCE ATJF1256R8M400DSPA9K000
	SIZE/TYPE 10.0 x 12.5		BUSINESS UNIT eiCap		ORDER CODE 860241375001	
				STATUS	PAGE	
				Valid	6/9	

All products shall be used before the end of the period of 12 months based on the product date code, if not a 100 % solderability cannot be guaranteed. The capacitance tolerance as specified within the datasheet is only valid on the date of delivery.

1.09 Wave Soldering

- The detailed soldering instruction is given within Soldering Specification in this datasheet.
- During wave soldering only the pins / terminals should have contact with hot solder bath / wave. Assure that no direct contact of capacitor body with hot solder bath / wave or any other component will happen. Soldering must be done from the opposite PCB side where capacitor body is placed.

1.10 Hand Soldering

Take care that the tip of solder iron will only contact pins or leadframe of the capacitor to avoid any possible damage of the capacitor.

1.11 Cleaning

Do not wash the assembled capacitors with the following cleaning agents:

- petroleum system solvents: may cause degeneration of the rubber seal material
- alkali system solvents: may cause corrosion and dissolve of the aluminum case
- halogenated solvents: may cause corrosion and failure of the capacitor
- acetone: component marking may be erased
- xylene: may cause deterioration of the rubber seal material

Verify the following points when washing is applied to capacitors:

- Please monitor conductivity, ph-value, specific gravity and the water content of cleaning agents. Contamination adversely affects these characteristics.
- Be sure to not expose the capacitors under solvent rich conditions or keep capacitors inside a closed container. In addition, please dry the solvents on the PCB and the capacitor sufficiently with an air knife (temperature should be less than the maximum rated category temperature of the capacitor) for 10 minutes.
- Capacitors can be characteristically and catastrophically damaged by halogen ions, particularly by chlorine ions. The degree of the damage mainly depends upon the characteristics of the electrolyte and rubber seal material. When halogen ions come into contact with the inside of the capacitors, the foil may corrode, when a voltage is applied. This corrosion causes an extremely high leakage current, which results in venting and an open circuit defect.

All other cleaning processes and cleaning agents are not approved by Würth Elektronik eiSos. All cleaning methods need to be tested and validated by the customer.

1.12 Adhesives and Coating Materials

The usage of any adhesive or coating material, which is containing halogenated solvents, is not allowed.

Before applying adhesives or coating materials, make sure that the following points are fulfilled:

- Take care that the surface and capacitor is dry and clean before applying adhesive or coating, to avoid any contamination with flux residues or cleaning solvents.
- Assure that no flux residue or spot is left between the rubber seal material of the capacitor and the PCB.
- Do not fully cover the entire rubber seal surface with adhesive, coating or molding materials. Otherwise the covering of the full rubber seal surface may restrain the natural diffusion of hydrogen gas. Block maximum 80% of the sealed section of a capacitor.
- If the used adhesive, coating or molding material is containing halogen ions in a large amount, the halogen ions can diffuse and creep into the capacitor and can damage the capacitor. Both above explained circumstances can result in serious failures.
- Follow the specified heating and curing instructions given by supplier of the used adhesive or coating material. Avoid excessive pressure or heat on the capacitor by applying coating or adhesive.
- Take care that hardening of adhesive, coating material was correctly done, so that no solvents do remain.
- Be aware, that used solvents within adhesive and coating materials can damage the sleeve of the capacitor and can result in changes of the appearance of the sleeve (color, shine and marking).

1.13 Mechanical Stress on lead wire and terminal

Do not stress the capacitor with the following actions:

- Applying any excessive force to the lead wire or terminal.
- Move or turn the capacitor after soldering to the PCB.
- Bending pins after soldering.
- Carrying the PCB by picking / holding the board via a capacitor.



1.14 Operation and Usage of the Capacitor

In operation and usage take care about the following points.

Do not use the capacitor within the following environmental conditions:

- Environment with high mechanical stress / shocks or vibration (please see this specific datasheet for permitted limits).
- Environment with high amount of damp condensation, water or types of oil.
- Direct sunlight, ozone, any kind of radiation or ultraviolet rays.
- Toxic gases (e.g. ammonium, chlorine and compounds, bromine and compounds, hydrogen sulfide, sulfuric acid).

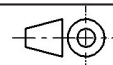
User should never touch the terminals of the capacitor directly.

	CHECKED	REVISION	DATE (YYYY-MM-DD)	GENERAL TOLERANCE	PROJECTION METHOD	
	PSL	001.001	2019-06-05	DIN ISO 2768-1m		
	DESCRIPTION WCAP-AT1H Aluminum Electrolytic Capacitors			TECHNICAL REFERENCE ATJF1256R8M400DSPA9K000		
	ORDER CODE 860241375001					
	SIZE/TYPE	BUSINESS UNIT	STATUS	PAGE		
	10.0 x 12.5	eiCap	Valid	7/9		



Avoid short circuit between terminals with any kind of conductive material (e.g. metal, fluid, acid, alkaline solution).

1.15 Maintenance

For industrial applications it is recommended to perform periodic inspections. Power supplies shall be turned off before inspection to discharge the capacitor. Check the following points in case of an inspection:

- Visual inspection of the capacitor to see, if the vent operated for pressure relief and if any leakage of electrolyte has taken place.
- Measurement of electrical characteristics of the capacitor (according to datasheet, especially leakage current, capacitance and dissipation factor).

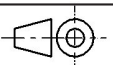
In case of deviation or failure according to the specified characteristics, take care to start appropriate actions (e.g. replacement of capacitor).

	CHECKED PSL	REVISION 001.001	DATE (YYYY-MM-DD) 2019-06-05	GENERAL TOLERANCE DIN ISO 2768-1m	PROJECTION METHOD 
				Würth Elektronik eiSos GmbH & Co. KG EMC & Inductive Solutions Max-Eyth-Str. 1 74638 Waldenburg Germany Tel. +49 (0) 79 42 945 - 0 www.we-online.com eiSos@we-online.com	
WCAP-AT1H Aluminum Electrolytic Capacitors			TECHNICAL REFERENCE ATJF1256R8M400DSPA9K000		
SIZE/TYPE 10.0 x 12.5			BUSINESS UNIT eiCap		ORDER CODE 860241375001
			STATUS Valid		PAGE 8/9

Important Notes

The following conditions apply to all goods within the product range of Würth Elektronik eiSos GmbH & Co. KG:

1. General Customer Responsibility

Some goods within the product range of Würth Elektronik eiSos GmbH & Co. KG contain statements regarding general suitability for certain application areas. These statements about suitability are based on our knowledge and experience of typical requirements concerning the areas, serve as general guidance and cannot be estimated as binding statements about the suitability for a customer application. The responsibility for the applicability and use in a particular customer design is always solely within the authority of the customer. Due to this fact it is up to the customer to evaluate, where appropriate to investigate and decide whether the device with the specific product characteristics described in the product specification is valid and suitable for the respective customer application or not.

2. Customer Responsibility related to Specific, in particular Safety-Relevant Applications

It has to be clearly pointed out that the possibility of a malfunction of electronic components or failure before the end of the usual lifetime cannot be completely eliminated in the current state of the art, even if the products are operated within the range of the specifications. In certain customer applications requiring a very high level of safety and especially in customer applications in which the malfunction or failure of an electronic component could endanger human life or health it must be ensured by most advanced technological aid of suitable design of the customer application that no injury or damage is caused to third parties in the event of malfunction or failure of an electronic component. Therefore, customer is cautioned to verify that data sheets are current before placing orders. The current data sheets can be downloaded at www.we-online.com.

3. Best Care and Attention

Any product-specific notes, cautions and warnings must be strictly observed. Any disregard will result in the loss of warranty.

4. Customer Support for Product Specifications

Some products within the product range may contain substances which are subject to restrictions in certain jurisdictions in order to serve specific technical requirements. Necessary information is available on request. In this case the field sales engineer or the internal sales person in charge should be contacted who will be happy to support in this matter.

5. Product R&D

Due to constant product improvement product specifications may change from time to time. As a standard reporting procedure of the Product Change Notification (PCN) according to the JEDEC-Standard inform about minor and major changes. In case of further queries regarding the PCN, the field sales engineer or the internal sales person in charge should be contacted. The basic responsibility of the customer as per Section 1 and 2 remains unaffected.

6. Product Life Cycle



Due to technical progress and economical evaluation we also reserve the right to discontinue production and delivery of products. As a standard reporting procedure of the Product Termination Notification (PTN) according to the JEDEC-Standard we will inform at an early stage about inevitable product discontinuance. According to this we cannot guarantee that all products within our product range will always be available. Therefore it needs to be verified with the field sales engineer or the internal sales person in charge about the current product availability expectancy before or when the product for application design-in disposal is considered. The approach named above does not apply in the case of individual agreements deviating from the foregoing for customer-specific products.

7. Property Rights

All the rights for contractual products produced by Würth Elektronik eiSos GmbH & Co. KG on the basis of ideas, development contracts as well as models or templates that are subject to copyright, patent or commercial protection supplied to the customer will remain with Würth Elektronik eiSos GmbH & Co. KG. Würth Elektronik eiSos GmbH & Co. KG does not warrant or represent that any license, either expressed or implied, is granted under any patent right, copyright, mask work right, or other intellectual property right relating to any combination, application, or process in which Würth Elektronik eiSos GmbH & Co. KG components or services are used.

8. General Terms and Conditions

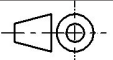
Unless otherwise agreed in individual contracts, all orders are subject to the current version of the "General Terms and Conditions of Würth Elektronik eiSos Group", last version available at www.we-online.com.

	CHECKED PSL	REVISION 001.001	DATE (YYYY-MM-DD) 2019-06-05	GENERAL TOLERANCE DIN ISO 2768-1m	PROJECTION METHOD 
				WÜRTH ELEKTRONIK Würth Elektronik eiSos GmbH & Co. KG EMC & Inductive Solutions Max-Eyth-Str. 1 74638 Waldenburg Germany Tel. +49 (0) 79 42 945 - 0 www.we-online.com eiSos@we-online.com	
DESCRIPTION WCAP-AT1H Aluminum Electrolytic Capacitors				TECHNICAL REFERENCE ATJF1256R8M400DSPA9K000	
SIZE/TYPE 10.0 x 12.5				ORDER CODE 860241375001	
BUSINESS UNIT eiCap		STATUS Valid		PAGE 9/9	

Mouser Electronics

Authorized Distributor

Click to View Pricing, Inventory, Delivery & Lifecycle Information:

[Wurth Elektronik:](#)

[860241375001](#)