

RECOMMENDED PCB LAYOUT - COMPONENT VIEW

TECHNICAL CHARACTERISTICS

MATERIAL  
 INSULATOR: PA 66  
 FLAMMABILITY RATING: UL94-V0  
 COLOR: GREY  
 WIRE GUARD: STAINLESS STEEL  
 CONTACT PIN: BRASS (CuZn)  
 SOLDER TAIL PLATING: TIN

ENVIRONMENTAL  
 OPERATING TEMPERATURE: -40 UP TO 115°C  
 COMPLIANCE: LEAD FREE AND ROHS

ELECTRICAL  
 CURRENT RATING: 15 A  
 WORKING VOLTAGE: 300 VAC  
 WITHSTANDING VOLTAGE: 1.6 KV  
 CONTACT RESISTANCE: 20 mOhm MAX

STANDARD  
 RoHS CERTIFIED E315414

MECHANICAL  
 SOLID WIRE: 28-12 AWG / 0.08-3.31 MM<sup>2</sup>  
 STRANDED WIRE: 28-12 AWG / 0.08-3.31 MM<sup>2</sup>  
 WIRE STRIP LENGTH: 5-6 MM

MECHANICAL:  
 PITCH: 5.0MM

SOLDERING  
 JEDEC LEAD FREE WAVE SOLDERING

PACKAGING  
 BOX

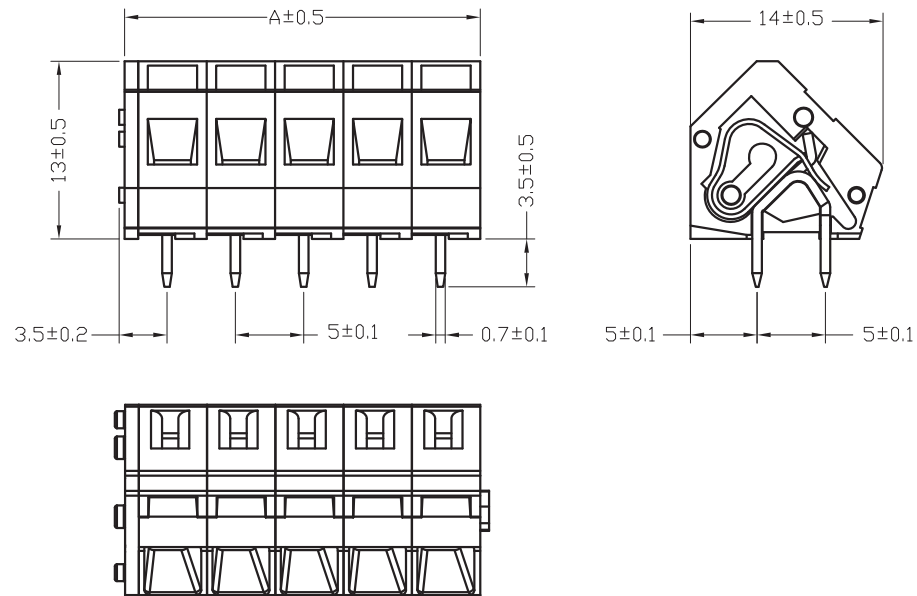

Pitch : 5.00mm

Poles	A(mm)	Poles	A(mm)
1	6.00	15	76.00
2	11.00	16	81.00
3	16.00	17	86.00
4	21.00	18	91.00
5	26.00	19	96.00
6	31.00	20	101.00
7	36.00	21	106.00
8	41.00	22	111.00
9	46.00	23	116.00
10	51.00	24	121.00
11	56.00		
12	61.00		
13	66.00		
14	71.00		

RoHS Compliant

G			
F			
E			
D	01-FEB-16	MECHANICAL	AK
C	21-SEP-15	MECHANICAL	AK
B	24-SEP-13	DWG REVIEW	QL
A	02-JUL-12	PDF	GG
REV	DATE	FILE	BY

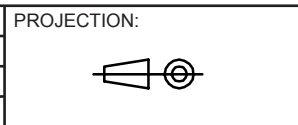

APPROVAL: FBr

GENERAL TOLERANCE  
 .X = +/- 0.2  
 .XX = +/- 0.15

UNIT: MM  
 SCALE:  
 SHEET: 1/2  
 DRAW:



DESCRIPTION: SERIE 413 B - 5.00 MM SCREWLESS 45° ENTRY - WR-TBL  
 WERI PART NO: 691 413 720 0xx B

SIZE  
**A4**

A

B

C

D

1

2

3

4

5

## Cautions and Warnings:

This electronic component is designed and developed with the intention for use in general electronics equipments.

Before incorporating the components into any equipments in the field such as aerospace, aviation, nuclear control, submarine, transportation, (automotive control, train control, ship control), transportation signal, disaster prevention, medical, public information network etc. where higher safety and reliability are especially required or if there is possibility of direct damage or injury to human body, Würth Elektronik must be asked for a written approval.

In addition, even electronic component in general electronic equipments, when used in electrical circuits that require high safety, reliability functions or performance, the sufficient reliability evaluation-check for the safety must be performed before by the user before usage.

A

B

C

RoHS Compliant

G				PROJECTION: 	GENERAL TOLERANCE .X = +/- 0.2 .XX = +/- 0.15		
F							
E							
D							
C				APPROVAL: JC	UNIT: MM	DESCRIPTION: DISCLAIMER	SIZE <b>A4</b>
B					SCALE:		
A	10-SEP-14	PDF	QL		SHEET: 2/2	WERI PART NO: DISCLAIMER	
REV	DATE	FILE	BY		DRAW: QL		

D

# Mouser Electronics

Authorized Distributor

Click to View Pricing, Inventory, Delivery & Lifecycle Information:

[Wurth Elektronik:](#)

[691413720005B](#)