

1

2

3

4

5

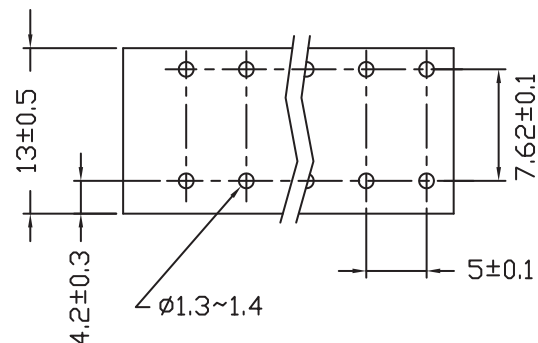

RECOMMENDED PCB LAYOUT - COMPONENT VIEW

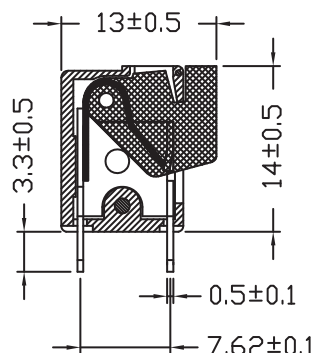
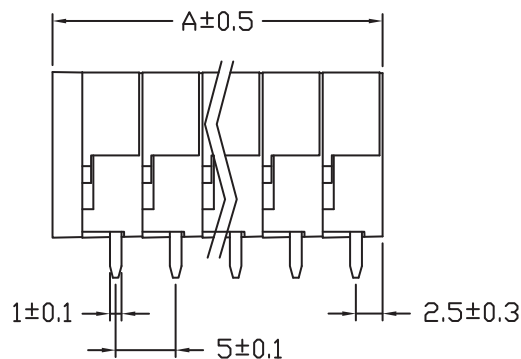

Pitch : 5.00mm			
Poles	A(mm)	Poles	A(mm)
2	12.54	15	77.54
3	17.54	16	82.54
4	22.54	17	
5	27.54	18	
6	32.54	19	
7	37.54	20	
8	42.54	21	
9	47.54	22	
10	52.54	23	
11	57.54	24	
12	62.54	25	
13	67.54	26	
14	72.54	27	

TECHNICAL CHARACTERISTICS

MATERIAL
 INSULATOR: PA66
 FLAMABILITY RATING: UL94-V0
 COLOR: GREEN/ORANGE
 METAL HOUSING: BRASS (CuZn)
 WIRE GUARD: STAINLESS STEEL
 SOLDER TAIL PLATING: TIN

ENVIRONMENTAL
 OPERATING TEMPERATURE: -40 UP TO 105°C
 COMPLIANCE: LEAD FREE AND ROHS

ELECTRICAL	cULus	VDE
CURRENT RATING:	10A	16A
WORKING VOLTAGE:	300VAC	450VAC
WITHSTANDING VOLTAGE:	2.0KV	-
CONTACT RESISTANCE:	20mOhm MAX	-

STANDARD

CERTIFIED E315414
 CERTIFIED 40036896

MECHANICAL

SOLID WIRE: 24-14 AWG / 0.205-2.08 MM²
 STRANDED WIRE: 24-14 AWG / 0.205-2.08 MM²

WIRE STRIPE LENGTH: 6 - 10 MM
 PITCH: 5.0 MM

SOLDERING

JEDEC LEAD FREE WAVE PROCESS ONLY

PACKAGING
 BOX

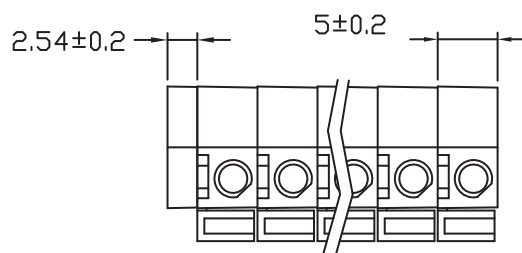

RoHS Compliant

G				PROJECTION: 	GENERAL TOLERANCE .X = +/- 0.2 .XX = +/- 0.15	 WÜRTH ELEKTRONIK	
F							
E							
D							
C				APPROVAL: RJ	UNIT: MM	DESCRIPTION: SERIE 401 B - 5.00MM SCREWLESS VERTICAL ENTRY WR-TBL	SIZE A4
B	21-NOV-12	WIRE STRIP 6-7MM	QL		SCALE:		
A	02-JUL-12	PDF	GG		SHEET: 1/2	WERI PART NO: 691 401 700 0xx B	
REV	DATE	FILE	BY		DRAW: MARVIN		

1

2

3

4

5

Cautions and Warnings:

This electronic component is designed and developed with the intention for use in general electronics equipments.

Before incorporating the components into any equipments in the field such as aerospace, aviation, nuclear control, submarine, transportation, (automotive control, train control, ship control), transportation signal, disaster prevention, medical, public information network etc. where higher safety and reliability are especially required or if there is possibility of direct damage or injury to human body, Würth Elektronik must be asked for a written approval.

In addition, even electronic component in general electronic equipments, when used in electrical circuits that require high safety, reliability functions or performance, the sufficient reliability evaluation-check for the safety must be performed before by the user before usage.

A

B

C

RoHS Compliant

G				PROJECTION: 	GENERAL TOLERANCE .X = +/- 0.2 .XX = +/- 0.15		
F							
E							
D							
C				APPROVAL: JC	UNIT: MM	DESCRIPTION: DISCLAIMER	SIZE A4
B					SCALE:		
A	10-SEP-14	PDF	QL		SHEET: 2/2	WERI PART NO: DISCLAIMER	
REV	DATE	FILE	BY		DRAW: QL		

D

Mouser Electronics

Authorized Distributor

Click to View Pricing, Inventory, Delivery & Lifecycle Information:

[Wurth Elektronik:](#)

[691401700009B](#)