

1

2

3

4

5

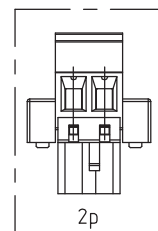
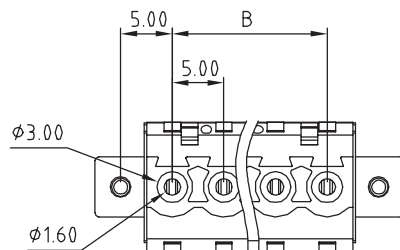

TECHNICAL CHARACTERISTICS

MATERIAL
 INSULATOR: PA 66
 FLAMMABILITY RATING: UL94-V0
 COLOR: GREEN
 METAL HOUSING: BRASS (CuZn)
 TERMINAL SCREW: STEEL ZINC PLATING
 TERMINAL SCREW SLOT TYPE: "I"
 CONTACT: BRASS
 WIRE GUARD: PhBz TIN PLATED
 FLANGES SCREW: STEEL M2.5

ENVIRONMENTAL
 OPERATING TEMPERATURE: -40 UP TO 105°C
 COMPLIANCE: LEAD FREE AND ROHS

ELECTRICAL	cULus	VDE
CURRENT RATING:	15 A	17 A
WORKING VOLTAGE:	300 VAC	300 VAC
WITHSTANDING VOLTAGE:	1.6 KV	2.5 KV
CONTACT RESISTANCE:	20 mOhm max	

STANDARD
 CERTIFIED E315414
 CERTIFIED 40023402

MECHANICAL	
SOLID WIRE:	24-12 AWG / 0.2-3.0 MM ²
STRANDED WIRE:	24-12 AWG / 0.2-3.0 MM ²
TORQUE:	3.5 Lb-In / 0.4 Nm



WIRE STRIPE LENGTH: 6-7 MM
 SCREW: M3.0
 PITCH: 5.00 MM

PACKAGING
 BOX

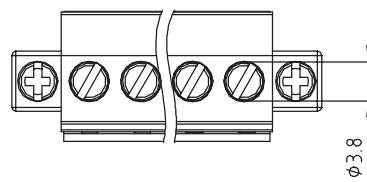
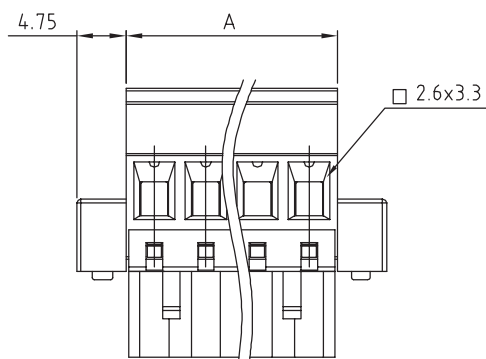
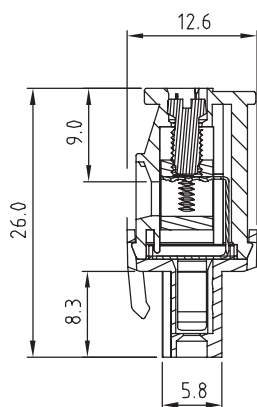
DIMENSION
 A = (NB. PINS - 1) x PITCH
 B = NB. PINS x PITCH

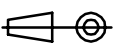

RoHS Compliant

G				PROJECTION: 	GENERAL TOLERANCE .X = ± 0.2 .XX = ± 0.15	 WÜRTH ELEKTRONIK	
F							
E							
D	20-APR-16	DRAWING	AK				
C	21-OCT-09	SCREW	JP	APPROVAL: FBr	UNIT: MM	DESCRIPTION: SERIE 3407 - 5.00MM HORIZONTAL CABLE ENTRY PLUG WITH FLANGES & HOOK ON WIRE SIDE - WR-TBL	
B	13-OCT-09	STANDARD	JP		SCALE:		WERI PART NO: 691 340 700 0xx
A	04-NOV-08	PDF	JP		SHEET: 1/2		
REV	DATE	FILE	BY		DRAW: MARVIN		

A

B

C

D

A4

1

2

3

4

5

Cautions and Warnings:

This electronic component is designed and developed with the intention for use in general electronics equipments.

Before incorporating the components into any equipments in the field such as aerospace, aviation, nuclear control, submarine, transportation, (automotive control, train control, ship control), transportation signal, disaster prevention, medical, public information network etc. where higher safety and reliability are especially required or if there is possibility of direct damage or injury to human body, Würth Elektronik must be asked for a written approval.

In addition, even electronic component in general electronic equipments, when used in electrical circuits that require high safety, reliability functions or performance, the sufficient reliability evaluation-check for the safety must be performed before by the user before usage.

A

B

C

RoHS Compliant

G				PROJECTION: 	GENERAL TOLERANCE .X = +/- 0.2 .XX = +/- 0.15		
F							
E							
D							
C				APPROVAL: JC	UNIT: MM	DESCRIPTION: DISCLAIMER	SIZE A4
B					SCALE:		
A	10-SEP-14	PDF	QL		SHEET: 2/2	WERI PART NO: DISCLAIMER	
REV	DATE	FILE	BY		DRAW: QL		

D

Mouser Electronics

Authorized Distributor

Click to View Pricing, Inventory, Delivery & Lifecycle Information:

[Wurth Elektronik:](#)

[691340700004](#)