

1

2

3

4

5

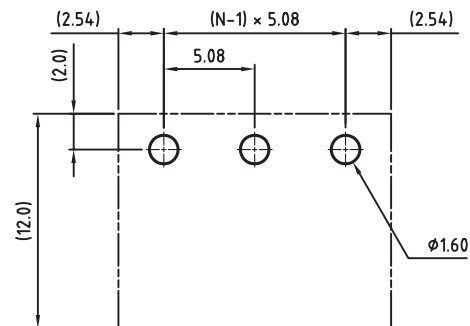

PCB LAYOUT - COMPONENT VIEW

TECHNICAL CHARACTERISTICS

MATERIAL
 INSULATOR: PA 66
 FLAMABILITY RATING: UL94-V0
 COLOR: GREEN
 CONTACT PIN: BRASS (CuZn)
 SOLDER TAIL PLATING: TIN

ENVIRONMENTAL
 OPERATING TEMPERATURE: -40 UP TO 105°C
 COMPLIANCE: LEAD FREE AND ROHS

ELECTRICAL	cULus	VDE
CURRENT RATING:	20A	20A
WORKING VOLTAGE:	300VAC	300VAC
WITHSTANDING VOLTAGE:	1.6KV	2.5KV
CONTACT RESISTANCE:	20 mOhm MAX	

MECHANICAL
 PITCH: 5.08MM

SOLDERING: WAVE PROCESS ONLY



PACKAGING: BOX

SERIE 312

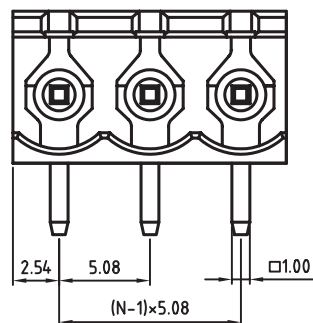
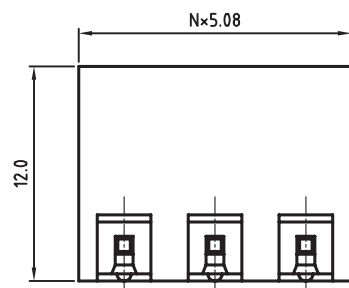
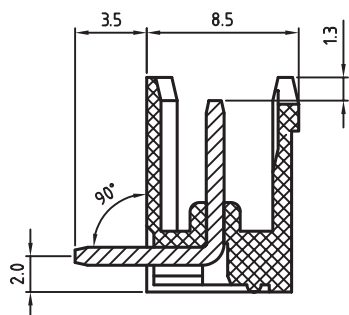
CERTIFICATION

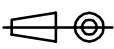

RoHS Compliant

G				PROJECTION: 	GENERAL TOLERANCE .X = +/- 0.2 .XX = +/- 0.15		DESCRIPTION: SERIE 312 - 5.08MM OPEN HORIZONTAL PCB HEADER WR-TBL	SIZE A4
F								
E								
D								
C	23-OCT-14	MATERIAL	AS					
B	29-OCT-08	CHARACTERISTICS	JP		SCALE:	DESCRIPTION: SERIE 312 - 5.08MM OPEN HORIZONTAL PCB HEADER WR-TBL	SIZE A4	
A	31-OCT-07	PDF	EC		SHEET: 1/2	WERI PART NO: 691 312 510 0xx	SIZE A4	
REV	DATE	FILE	BY		DRAW: AS		SIZE A4	

1

2

3

4

5

Cautions and Warnings:

This electronic component is designed and developed with the intention for use in general electronics equipments.

Before incorporating the components into any equipments in the field such as aerospace, aviation, nuclear control, submarine, transportation, (automotive control, train control, ship control), transportation signal, disaster prevention, medical, public information network etc. where higher safety and reliability are especially required or if there is possibility of direct damage or injury to human body, Würth Elektronik must be asked for a written approval.

In addition, even electronic component in general electronic equipments, when used in electrical circuits that require high safety, reliability functions or performance, the sufficient reliability evaluation-check for the safety must be performed before by the user before usage.

A

B

C

RoHS Compliant

G				PROJECTION: 	GENERAL TOLERANCE .X = +/- 0.2 .XX = +/- 0.15		
F							
E							
D							
C				APPROVAL: JC	UNIT: MM	DESCRIPTION: DISCLAIMER	SIZE A4
B					SCALE:		
A	10-SEP-14	PDF	QL		SHEET: 2/2	WERI PART NO: DISCLAIMER	
REV	DATE	FILE	BY		DRAW: QL		

D

Mouser Electronics

Authorized Distributor

Click to View Pricing, Inventory, Delivery & Lifecycle Information:

[Wurth Elektronik:](#)

[691312510021](#)