

N=Number of contacts

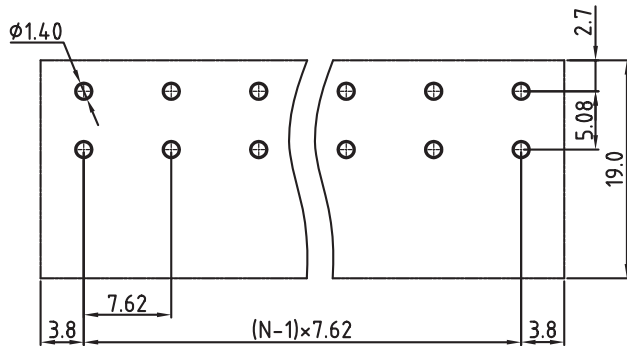
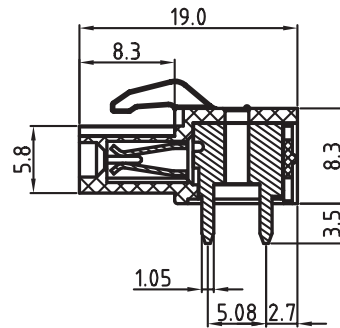
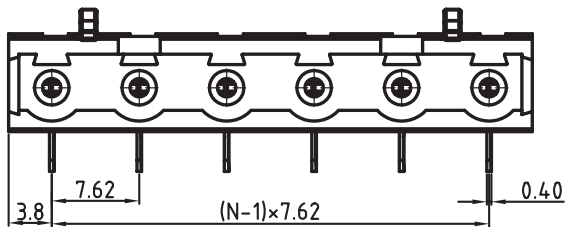

PCB LAYOUT - COMPONENT VIEW

TECHNICAL CHARACTERISTICS

MATERIAL
 INSULATOR: PA 66
 FLAMABILITY RATING: UL94-V0
 COLOR: GREEN
 CONTACT: BRASS
 WIRE GUARD: PhBz TIN PLATED

ENVIRONMENTAL
 OPERATING TEMPERATURE: -40 UP TO 105°C
 COMPLIANCE: LEAD FREE AND ROHS

ELECTRICAL
 CURRENT RATING: 20A
 WORKING VOLTAGE: 300VAC
 WITHSTANDING VOLTAGE: 1.6KV
 CONTACT RESISTANCE: 20 mOhm max

STANDARD
 CERTIFIED E315414 / MODEL NUMBER 3094

MECHANICAL
 PITCH: 7.62MM

SOLDERING: WAVE PROCESS ONLY

PACKAGING: BOX

SERIE 3094

RoHS Compliant			
G			
F			
E			
D			
C	05-OCT-10	CURRENT RATING	JC
B	16-OCT-09	STANDARD	JP
A	05-NOV-08	PDF	JP
REV	DATE	FILE	BY

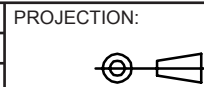

GENERAL TOLERANCE
 .X = +/- 0.2
 .XX = +/- 0.15



APPROVAL: RJ

UNIT: MM

DESCRIPTION: SERIE 3094 - 7.62MM REVERSED GENDER HORIZONTAL PCB HEADER WR-TBL

SIZE

SCALE:

WERI PART NO: 691 309 410 0xx

A4

SHEET: 1/1

DRAW: MARVIN

Mouser Electronics

Authorized Distributor

Click to View Pricing, Inventory, Delivery & Lifecycle Information:

[Wurth Elektronik:](#)

[691309410008](#)