

1

2

3

4

5

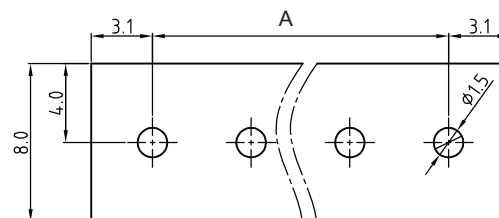

PCB LAYOUT - COMPONENT VIEW

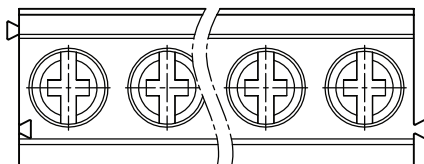
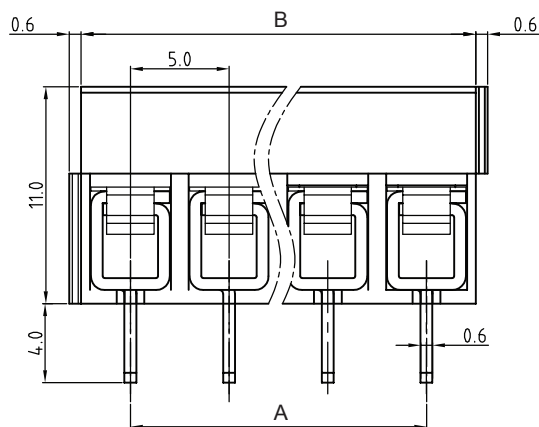
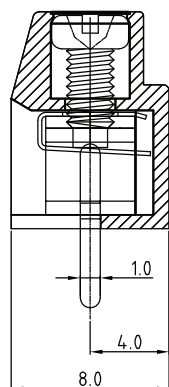

## TECHNICAL CHARACTERISTICS

MATERIAL  
 INSULATOR: PA 66  
 FLAMMABILITY RATING: UL94-V0  
 COLOR: GREEN  
 METAL HOUSING: BRASS (CuZn)  
 TERMINAL SCREW: STEEL ZINC PLATING "+/-" SLOT TYPE  
 WIRE GUARD: STAINLESS STEEL  
 SURFACE OF SOLDER TAIL PLATING: TIN

ENVIRONMENTAL  
 OPERATING TEMPERATURE: -40 UP TO 105°C  
 COMPLIANCE: LEAD FREE AND ROHS

ELECTRICAL  
 CURRENT RATING: 15 A  
 WORKING VOLTAGE: 250 VAC  
 WITHSTANDING VOLTAGE: 2.5 KV  
 CONTACT RESISTANCE: 20 mOhm MAX

STANDARD  
 CERTIFIED E315414

MECHANICAL  
 SOLID WIRE: 24-14 AWG / 0.205-2.08 MM<sup>2</sup>  
 STRANDED WIRE: 24-14 AWG / 0.205-2.08 MM<sup>2</sup>  
 TORQUE: 2.6 Lb.In / 0.3 Nm

WIRE RANGE: WIRE STRIPE LENGTH: 5-6 MM  
 SCREW: M2.5  
 PITCH: 5.0 MM

SOLDERING  
 JEDEC LEAD FREE WAVE SOLDERING

PACKAGING  
 BOX

DIMENSION  
 A = (NB. PINS - 1) x PITCH  
 B = NB. PINS x PITCH

RoHS Compliant

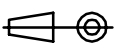
RoHS Compliant				PROJECTION:	GENERAL TOLERANCE	 <b>WÜRTH ELEKTRONIK</b>	DESCRIPTION: SERIE 111 - 5.0MM HORIZONTAL ENTRY MODULAR WITH PRESSURE CLAMP - WR-TBL	SIZE <b>A4</b>
G					.X = +/- 0.30			
F	07-MAY-17	DRAWING	AK		.XX = +/- 0.20			
E	25-FEB-16	UPDATE	AK					
D	06-SEP-09	PACKAGING	JC					
C	12-OCT-09	STANDARD	JP					
B	30-OCT-08	CHARACTERISTICS	JP	APPROVAL: FBr				
A	30-OCT-07	PDF	EC					
REV	DATE	FILE	BY					

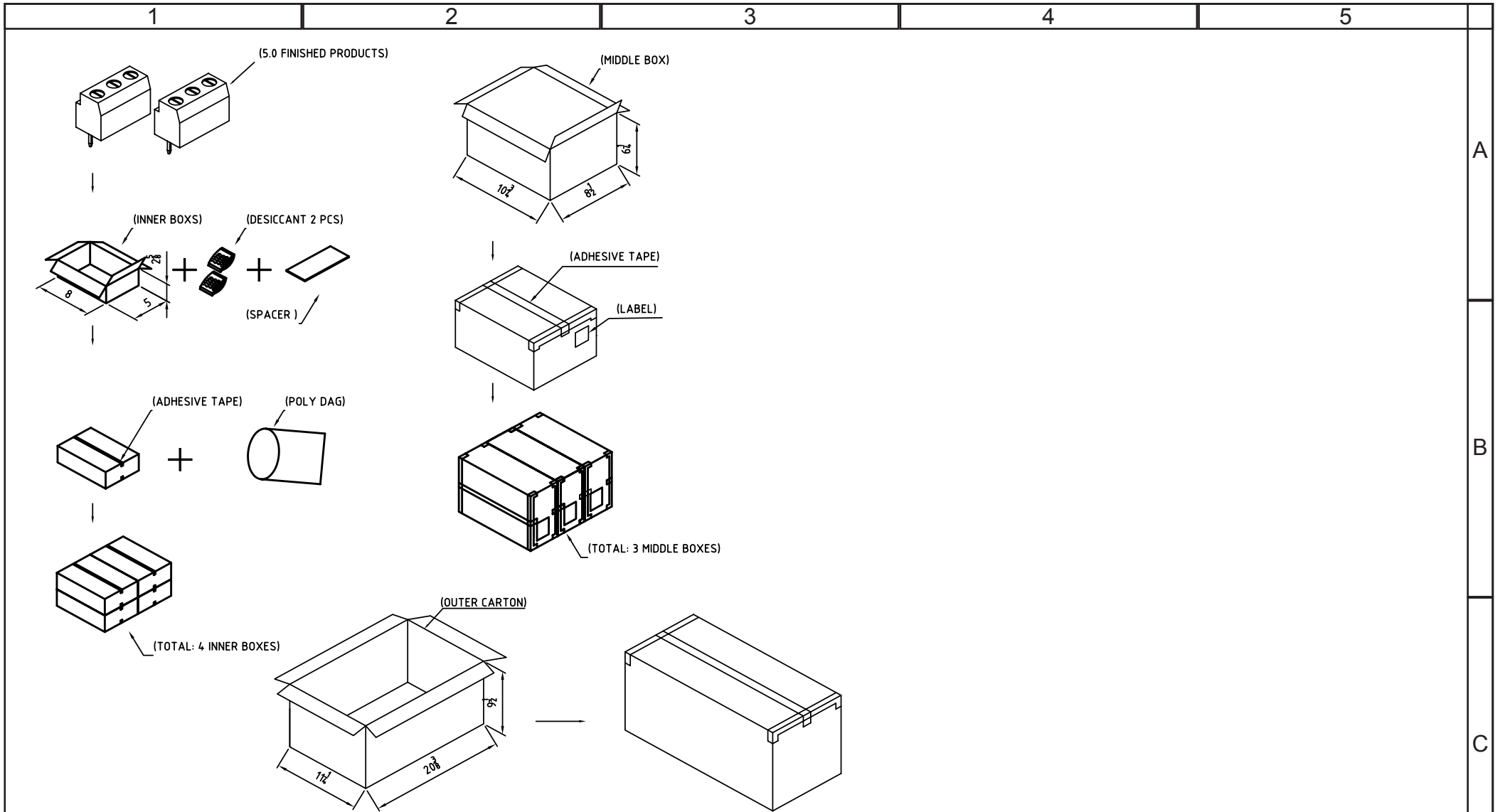

RoHS Compliant

G			
F			
E			
D			
C			
B			
A			
REV	DATE	FILE	BY

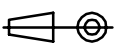
PROJECTION:  

GENERAL TOLERANCE  
 .X = +/- 0.2  
 .XX = +/- 0.15



APPROVAL: FBr

UNIT: MM  
 SCALE:  
 SHEET: 2/3  
 DRAW: PEARL

DESCRIPTION: SERIE 111 - 5.0MM HORIZONTAL ENTRY MODULAR WITH PRESSURE CLAMP - WR-TBL  
 WERI PART NO: 691 111 710 0xx

SIZE  
**A4**

1

2

3

4

5

## Cautions and Warnings:

This electronic component is designed and developed with the intention for use in general electronics equipments.

Before incorporating the components into any equipments in the field such as aerospace, aviation, nuclear control, submarine, transportation, (automotive control, train control, ship control), transportation signal, disaster prevention, medical, public information network etc. where higher safety and reliability are especially required or if there is possibility of direct damage or injury to human body, Würth Elektronik must be asked for a written approval.

In addition, even electronic component in general electronic equipments, when used in electrical circuits that require high safety, reliability functions or performance, the sufficient reliability evaluation-check for the safety must be performed before by the user before usage.

A

B

C

RoHS Compliant

G				PROJECTION: 	GENERAL TOLERANCE .X = +/- 0.2 .XX = +/- 0.15		
F							
E							
D							
C				APPROVAL: JC	UNIT: MM	DESCRIPTION: DISCLAIMER	SIZE <b>A4</b>
B					SCALE:		
A	10-SEP-14	PDF	QL		SHEET: 3/3	WERI PART NO: DISCLAIMER	
REV	DATE	FILE	BY		DRAW: QL		

D

# Mouser Electronics

Authorized Distributor

Click to View Pricing, Inventory, Delivery & Lifecycle Information:

[Wurth Elektronik:](#)

[691111710003](#)