

TECHNICAL CHARACTERISTICS

MATERIAL
 INSULATOR: LCP
 FLAMMABILITY RATING: UL94-V0
 COLOR: BEIGE
 CONTACT MATERIAL: PHOSPHOR BRONZE
 CONTACT TYPE: STAMPED
 CONTACT PLATING: TIN
 QUALITY CLASS: 25 MATING CYCLES
 PITCH: 1.00 MM

ENVIRONMENTAL
 OPERATING TEMPERATURE: -25 UP TO 85°C
 COMPLIANCE: LEAD FREE AND ROHS

ELECTRICAL
 CURRENT RATING: 1 A
 WORKING VOLTAGE: 50 VAC
 INSULATOR RESISTANCE: >100 MΩ
 DIELECTRIC WITHSTANDING VOLTAGE: 500 VAC/MN
 CONTACT RESISTANCE: 20 mΩ MAX

STANDARD
 CERTIFIED: E323964

SOLDERING
 JEDEC LEAD FREE REFLOW SOLDERING PROCESS

PACKAGING
 TAPE & REEL

DIMENSION
 A = NB. PIN -1
 B = NB. PIN +2
 C = NB. PIN +0.6

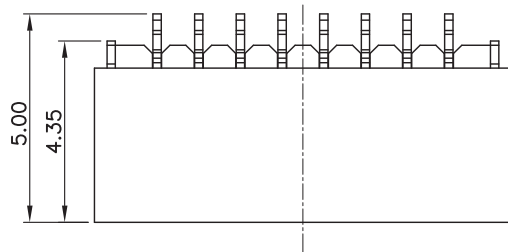
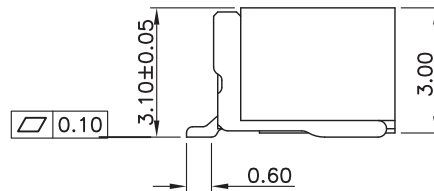
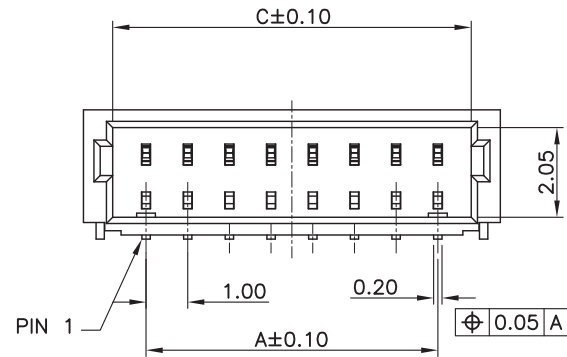

RoHS Compliant			
D	28-FEB-17	TPK	AK
C	25-OCT-16	PCN	AK
B	14-OCT-14	TPK DWG UPDATE	QL
A	16-JUL-14	PDF	AS
REV	DATE	FILE	BY

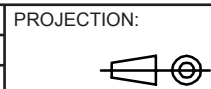

GENERAL TOLERANCE
 .X = +/- 0.30
 .XX = +/- 0.20



APPROVAL: BBu

UNIT: MM
 SCALE:
 SHEET: 1/3
 DRAW: AS

DESCRIPTION: WR-WTB 1.00 MM SMT MALE HORIZONTAL SHROUDED HEADER
 WERI PART NO: 665 1xx 131 822

SIZE
A4

1

2

3

4

5

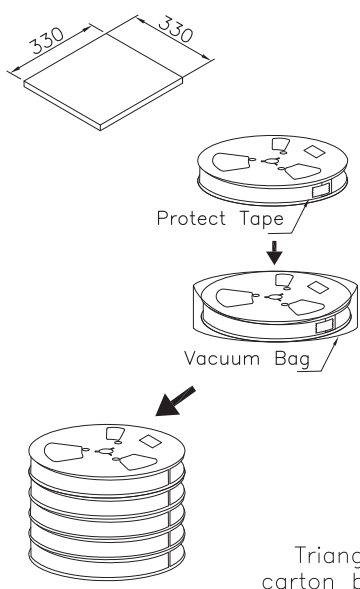
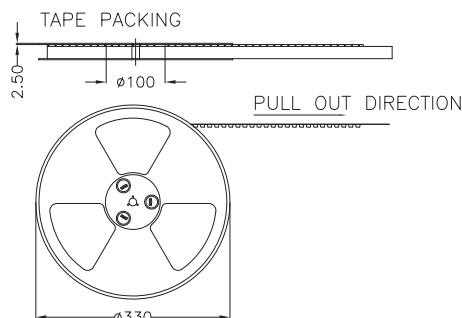

Note:
 1.All dimensions meet EIA-481-3 requirements.
 2.Material: BK Conductive Polystyrene Alloy
 100% recyclable.
 3.Thickness : 0.40±0.05mm
 4.Component load per 13" reel :1500 pcs.
 5.CARTON SIZE:350*350*296(mm)
 Vacuum bag:450*500*0.2(mm)

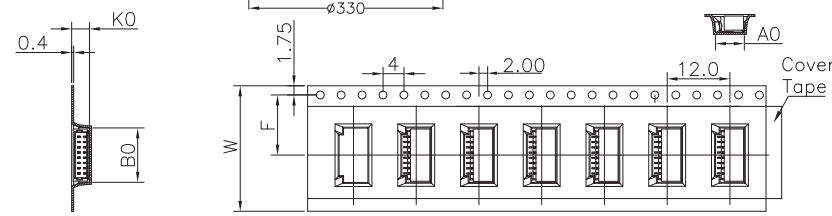

For Reel width (dimension W)16,24mm
 Single row hole

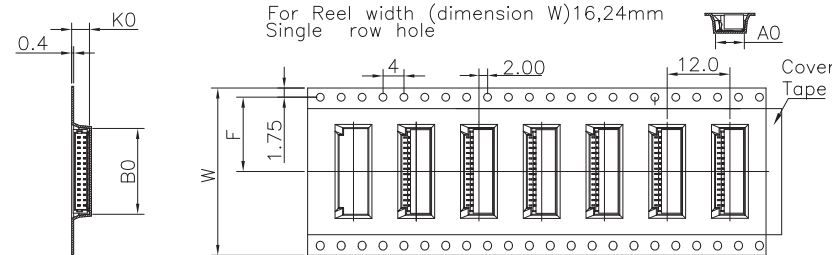

For Reel width (dimension W)32,44,56,72mm
 Double rows hole

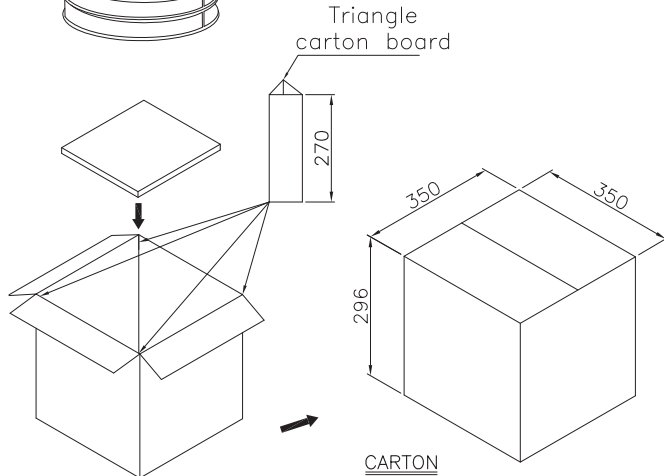

Pin	W	F	A0	B0	K0	PCS/R	R/CTN	Q'TY	Pin	W	F	A0	B0	K0	PCS/R	R/CTN	Q'TY
02	16	7.5	5.5	4.4	3.4	1500	12	18000	10	24	11.5	5.5	12.4	3.4	1500	9	13500
03	16	7.5	5.5	5.4	3.4	1500	12	18000	11	24	11.5	5.5	13.4	3.4	1500	9	13500
04	16	7.5	5.5	6.4	3.4	1500	12	18000	12	24	11.5	5.5	14.4	3.4	1500	9	13500
05	16	7.5	5.5	7.4	3.4	1500	12	18000	13	24	11.5	5.5	15.4	3.4	1500	9	13500
06	16	7.5	5.5	8.4	3.4	1500	12	18000	14	32	14.2	5.5	16.4	3.4	1500	7	10500
07	24	11.5	5.5	9.4	3.4	1500	9	13500	15	32	14.2	5.5	17.4	3.4	1500	7	10500
08	24	11.5	5.5	10.4	3.4	1500	9	13500	16	32	14.2	5.5	18.4	3.4	1500	7	10500
09	24	11.5	5.5	11.4	3.4	1500	9	13500	20	44	20.2	5.5	22.4	3.4	1500	5	7500

RoHS Compliant	
G	
F	
E	
D	
C	
B	
A	
REV	DATE
	FILE
	BY

PROJECTION:	
APPROVAL: BBu	

GENERAL TOLERANCE	.X = +/- 0.2
	.XX = +/- 0.15
UNIT: MM	
SCALE:	
SHEET: 2/3	
DRAW: AS	

DESCRIPTION: WR-WTB 1.00 MM SMT MALE HORIZONTAL SHROUDED HEADER
WERI PART NO: 665 1xx 131 822

SIZE
A4

A

B

C

D

1

2

3

4

5

Cautions and Warnings:

This electronic component is designed and developed with the intention for use in general electronics equipments.

Before incorporating the components into any equipments in the field such as aerospace, aviation, nuclear control, submarine, transportation, (automotive control, train control, ship control), transportation signal, disaster prevention, medical, public information network etc. where higher safety and reliability are especially required or if there is possibility of direct damage or injury to human body, Würth Elektronik must be asked for a written approval.

In addition, even electronic component in general electronic equipments, when used in electrical circuits that require high safety, reliability functions or performance, the sufficient reliability evaluation-check for the safety must be performed before by the user before usage.

A

B

C

RoHS Compliant

G				PROJECTION: 	GENERAL TOLERANCE .X = +/- 0.2 .XX = +/- 0.15		
F							
E							
D							
C				APPROVAL: JC	UNIT: MM	DESCRIPTION: DISCLAIMER	SIZE A4
B					SCALE:		
A	10-SEP-14	PDF	QL		SHEET: 3/3	WERI PART NO: DISCLAIMER	
REV	DATE	FILE	BY		DRAW: QL		

D

Mouser Electronics

Authorized Distributor

Click to View Pricing, Inventory, Delivery & Lifecycle Information:

[Wurth Elektronik:](#)

[665108131822](#)