

Section:A-A

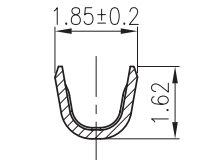

Section:B-B

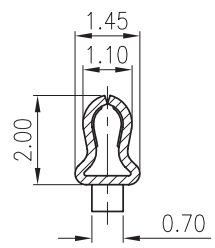

Section:C-C

TECHNICAL CHARACTERISTICS

MATERIAL
 CONTACT MATERIAL: COPPER ALLOY
 CONTACT TYPE: STAMPED
 CONTACT PLATING: TIN
 QUALITY CLASS: 25 MATING CYCLES
 PITCH: 2.50 MM

ENVIRONMENTAL
 OPERATING TEMPERATURE: -40 UP TO 105°C
 COMPLIANCE: LEAD FREE AND ROHS

ELECTRICAL
 CURRENT RATING: 3 A
 WORKING VOLTAGE: 250 VAC
 CONTACT RESISTANCE: 20 mOHM MAX

WIRE DIMENSION: 28-22 AWG

PACKAGING
 BULK/LOOSE DELIVERY IN A BAG
 EACH TERMINAL SEPARATED FROM EACH OTHER
 NOT ON A REEL
 100PCS/PER BAG. MULTIPLE OF 100 PCS ONLY
 1PC OF 64600113722DEC=1 CRIMP TERMINAL
 SO 1 BAG MEANS 100 PCS OF 64600113722DEC

RoHS Compliant			
G			
F			
E	25-JUL-18	TPK	AK
D	07-AUG-17	TPK	AK
C	05-OCT-16	TPK	AK
B	06-AUG-13	CHARACTERISTIC	QL
A	12-MAY-10	PDF	JP
REV	DATE	FILE	BY

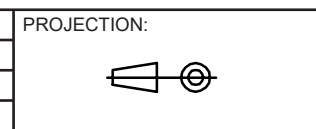

GENERAL TOLERANCE
 .X = +/- 0.2
 .XX = +/- 0.15



APPROVAL: BBu

UNIT: MM
 SCALE:
 SHEET: 1/3
 DRAW: MIKE

DESCRIPTION: 2.50 MM FEMALE CRIMP TERMINAL
 WERI PART NO: 646 001 137 22DEC

SIZE
A4

1

2

3

4

5

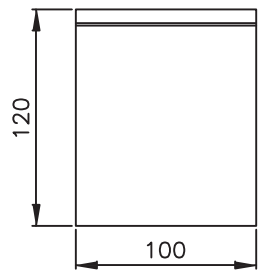
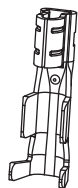

Packing Quantity:100 pcs/Bag



PE bag

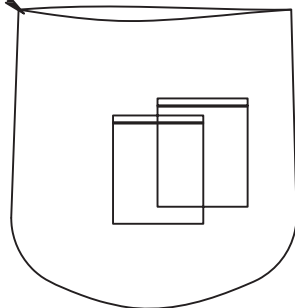

50 Bag/PE Bag
PE Bag:250*300*0.08

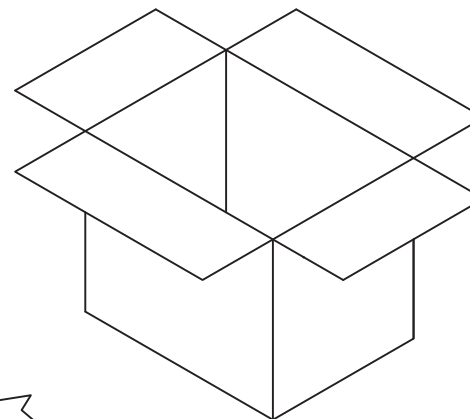

Packing Quantity:1100 Bag/Carton

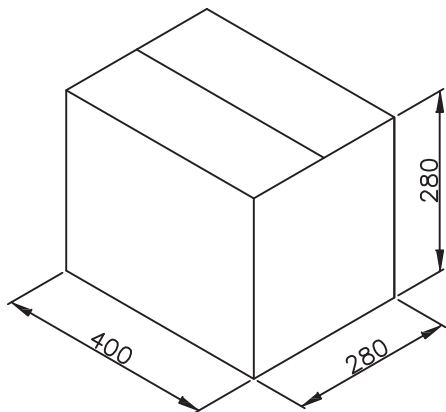

A

B

C

D

RoHS Compliant			
G			
F			
E			
D			
C			
B			
A			
REV	DATE	FILE	BY

PROJECTION:

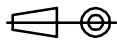

GENERAL TOLERANCE

.X = +/- 0.2

.XX = +/- 0.15

APPROVAL: BBu

UNIT: MM

SCALE:

SHEET: 2/3

DRAW: MIKE



DESCRIPTION: 2.50 MM FEMALE CRIMP TERMINAL

WERI PART NO: 646 001 137 22DEC

SIZE

A4

1

2

3

4

5

Cautions and Warnings:

This electronic component is designed and developed with the intention for use in general electronics equipments.

Before incorporating the components into any equipments in the field such as aerospace, aviation, nuclear control, submarine, transportation, (automotive control, train control, ship control), transportation signal, disaster prevention, medical, public information network etc. where higher safety and reliability are especially required or if there is possibility of direct damage or injury to human body, Würth Elektronik must be asked for a written approval.



In addition, even electronic component in general electronic equipments, when used in electrical circuits that require high safety, reliability functions or performance, the sufficient reliability evaluation-check for the safety must be performed before by the user before usage.

A

B

C

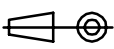
RoHS Compliant

G				PROJECTION: 	GENERAL TOLERANCE .X = +/- 0.2 .XX = +/- 0.15		
F							
E							
D							
C				APPROVAL: JC	UNIT: MM	DESCRIPTION: DISCLAIMER	SIZE A4
B					SCALE:		
A	10-SEP-14	PDF	QL		SHEET: 3/3	WERI PART NO: DISCLAIMER	
REV	DATE	FILE	BY		DRAW: QL		

D

Mouser Electronics

Authorized Distributor

Click to View Pricing, Inventory, Delivery & Lifecycle Information:

[Wurth Elektronik:](#)

[64600113722DEC](#)