

1

2

3

4

5

## TECHNICAL CHARACTERISTICS

MATERIAL  
 INSULATOR: ABS  
 FLAMABILITY RATING: UL94-HB  
 COLOR: BLACK  
 SCREW: UNC 4-40

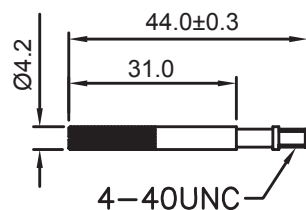
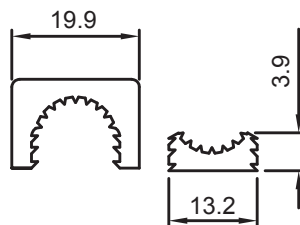
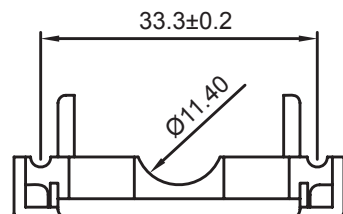
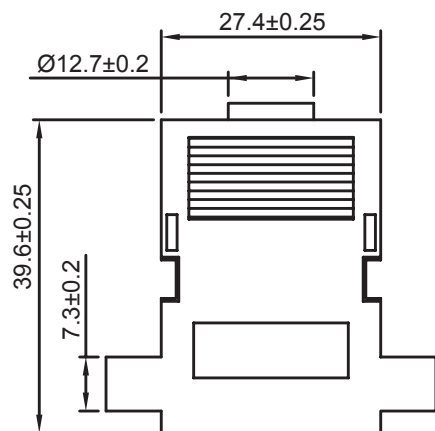
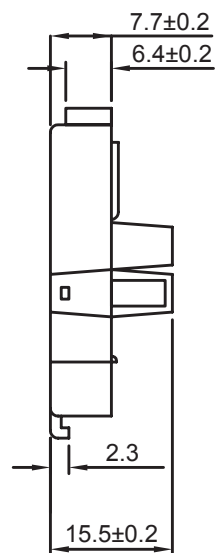

ENVIRONMENTAL  
 COMPLIANCE: LEAD FREE AND ROHS

PACKAGING: BAG

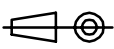

2 PCS

RoHS Compliant

G	17-NOV-14	PACKAGING	AS	PROJECTION: 	GENERAL TOLERANCE .X = +/- 0.2 .XX = +/- 0.15	
F	25-SEP-14	DRAWING+VIEWS	AS			
E	09-APR-13	MEASURE	AR			
D	20-MAR-13	FLAMABILITY	AR			
C	12-NOV-08	CHARACTERISTICS	JP	APPROVAL: NPr	UNIT: MM	DESCRIPTION: WR-DSUB - PLASTIC HOOD SMALL TOP ENTRY 4640 SCREW
B	31-MAR-04				SCALE:	WERI PART NO: 618 015 214 622
A	24-AUG-01	PDF	JP		SHEET: 1/3	
REV	DATE	FILE	BY		DRAW: AS	

SIZE

A4

A

B

C

D

1

2

3

4

5

A

B

C

D

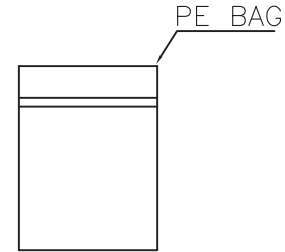
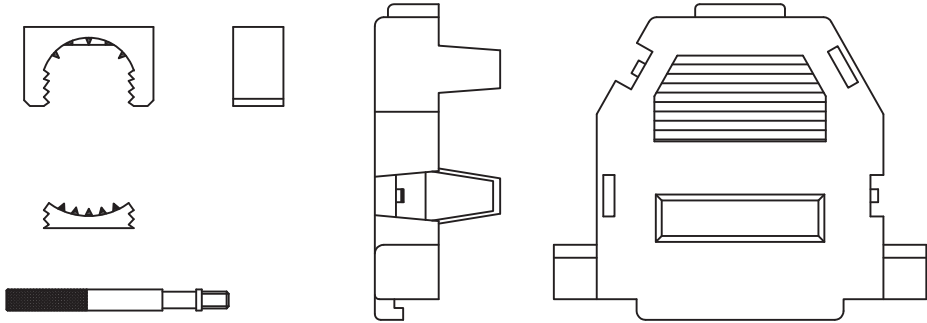
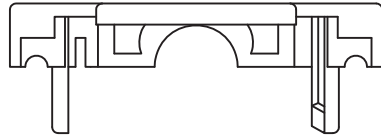

50 Pcs/Bag  
6 Bags/Carton  
300 Pcs/Carton

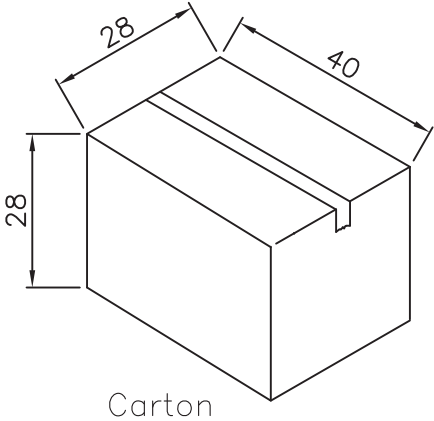

Carton

RoHS Compliant			
G			
F			
E			
D			
C			
B			
A	17-NOV-14	PDF	AS
REV	DATE	FILE	BY

PROJECTION:

GENERAL TOLERANCE  
.X = +/- 0.2  
.XX = +/- 0.15



APPROVAL: NPr

UNIT: MM  
SCALE:  
SHEET: 2/3  
DRAW: AS

DESCRIPTION: WR-DSUB - PLASTIC HOOD SMALL TOP ENTRY 4640 SCREW  
WERI PART NO: 618 015 214 622

SIZE  
**A4**

1

2

3

4

5

## Cautions and Warnings:

This electronic component is designed and developed with the intention for use in general electronics equipments.

Before incorporating the components into any equipments in the field such as aerospace, aviation, nuclear control, submarine, transportation, (automotive control, train control, ship control), transportation signal, disaster prevention, medical, public information network etc. where higher safety and reliability are especially required or if there is possibility of direct damage or injury to human body, Würth Elektronik must be asked for a written approval.

In addition, even electronic component in general electronic equipments, when used in electrical circuits that require high safety, reliability functions or performance, the sufficient reliability evaluation-check for the safety must be performed before by the user before usage.

A

B

C

RoHS Compliant

G				PROJECTION: 	GENERAL TOLERANCE .X = +/- 0.2 .XX = +/- 0.15		
F							
E							
D							
C				APPROVAL: JC	UNIT: MM	DESCRIPTION: DISCLAIMER	SIZE <b>A4</b>
B					SCALE:		
A	10-SEP-14	PDF	QL		SHEET: 3/3	WERI PART NO: DISCLAIMER	
REV	DATE	FILE	BY		DRAW: QL		

D

# Mouser Electronics

Authorized Distributor

Click to View Pricing, Inventory, Delivery & Lifecycle Information:

[Wurth Elektronik:](#)

[618015214622](#)