

TECHNICAL CHARACTERISTICS

MATERIAL
INSULATOR: PBT
FLAMMABILITY RATING: UL94-V0
COLOR: WHITE
CONTACT MATERIAL: COPPER ALLOY
CONTACT TYPE: STAMPED
CONTACT PLATING: SELECTIVE GOLD
SHIELDING: BRASS Ni PLATED
QUALITY CLASS: 1500 MATING CYCLES

ENVIRONMENTAL
OPERATING TEMPERATURE: -40 UP TO +105°C
COMPLIANCE: LEAD FREE AND ROHS

ELECTRICAL
CURRENT RATING: 1.5 A MAX
WORKING VOLTAGE: 30 VAC
INSULATOR RESISTANCE: >1000 MΩ
DIELECTRIC WITHSTANDING VOLTAGE: 750 VAC/MIN
CONTACT RESISTANCE: 20 mΩ MAX

STANDARD
CERTIFIED: E323964

SOLDERING
JEDEC LEAD FREE WAVE SOLDERING

PACKAGING
TRAY

| Pin NB. | Name |
|---------|------|
| 1 | Vbus |
| 2 | D- |
| 3 | D+ |
| 4 | GND |

| | | | |
|----------------|-----------|---------------|----|
| RoHS Compliant | | | |
| L | 25-JUL-16 | PIN-OUT | AK |
| K | 23-DEC-15 | PCN | AK |
| J | 01-SEP-15 | TPK | AK |
| I | 09-AVR-15 | PCB THICKNESS | QP |
| H | 27-OCT-14 | REVIEW | QL |
| REV | DATE | FILE | BY |

| | |
|---------------|--|
| PROJECTION: | |
| APPROVAL: NPr | |

| |
|-------------------|
| GENERAL TOLERANCE |
| .X = +/- 0.2 |
| .XX = +/- 0.15 |

| |
|------------|
| UNIT: MM |
| SCALE: |
| SHEET: 1/3 |
| DRAW: AK |

DESCRIPTION: DUAL USB 2.0 TYPE A VERTICAL

WERI PART NO: 614 008 235 023

SIZE
A4

1

2

3

4

5

A

B

C

D

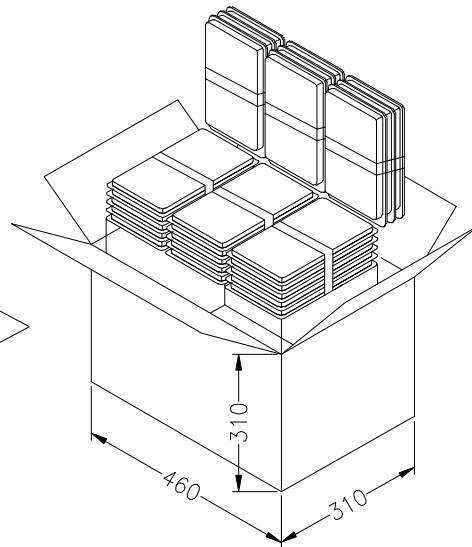
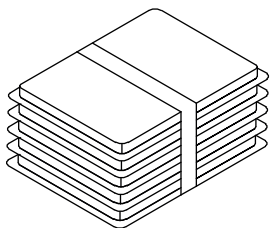
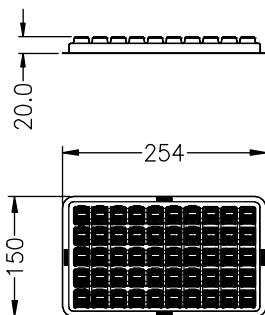
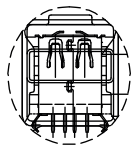

50 pcs/tray
 56 trays/carton
 2800 pcs/carton

| | | | |
|----------------|------|------|----|
| RoHS Compliant | | | |
| | | | |
| | | | |
| | | | |
| | | | |
| A | | | |
| REV | DATE | FILE | BY |

PROJECTION:

GENERAL TOLERANCE
 .X = +/- 0.2
 .XX = +/- 0.15



APPROVAL: NPr

UNIT: MM
 SCALE:
 SHEET: 2/3
 DRAW: AK

DESCRIPTION: DUAL USB 2.0 TYPE A VERTICAL
 WERI PART NO: 614 008 235 023

SIZE
A4

1

2

3

4

5

Cautions and Warnings:

This electronic component is designed and developed with the intention for use in general electronics equipments.

Before incorporating the components into any equipments in the field such as aerospace, aviation, nuclear control, submarine, transportation, (automotive control, train control, ship control), transportation signal, disaster prevention, medical, public information network etc. where higher safety and reliability are especially required or if there is possibility of direct damage or injury to human body, Würth Elektronik must be asked for a written approval.

In addition, even electronic component in general electronic equipments, when used in electrical circuits that require high safety, reliability functions or performance, the sufficient reliability evaluation-check for the safety must be performed before by the user before usage.

A

B

C

RoHS Compliant

PROJECTION:



GENERAL TOLERANCE

.X = +/- 0.2

.XX = +/- 0.15



APPROVAL: JC

UNIT: MM

SCALE:

SHEET: 3/3

DRAW: QL



DESCRIPTION: DISCLAIMER

WERI PART NO: DISCLAIMER

SIZE

A4

D

| | | | | | | | | | |
|-----|-----------|------|----|--|---|---|-------------------------|-------------------|--------------------------|
| G | | | | PROJECTION:  | GENERAL TOLERANCE .X = +/- 0.2 .XX = +/- 0.15 |  | DESCRIPTION: DISCLAIMER | SIZE A4 | |
| F | | | | | | | | | |
| E | | | | | | | | | |
| D | | | | | | | | | |
| C | | | | APPROVAL: JC | UNIT: MM |  | DESCRIPTION: DISCLAIMER | SIZE A4 | |
| B | | | | | SCALE: | | | | |
| A | 10-SEP-14 | PDF | QL | | SHEET: 3/3 | | | | WERI PART NO: DISCLAIMER |
| REV | DATE | FILE | BY | | DRAW: QL | | | | |

Mouser Electronics

Authorized Distributor

Click to View Pricing, Inventory, Delivery & Lifecycle Information:

[Wurth Elektronik:](#)

[614008235023](#)