

1

2

3

4

5

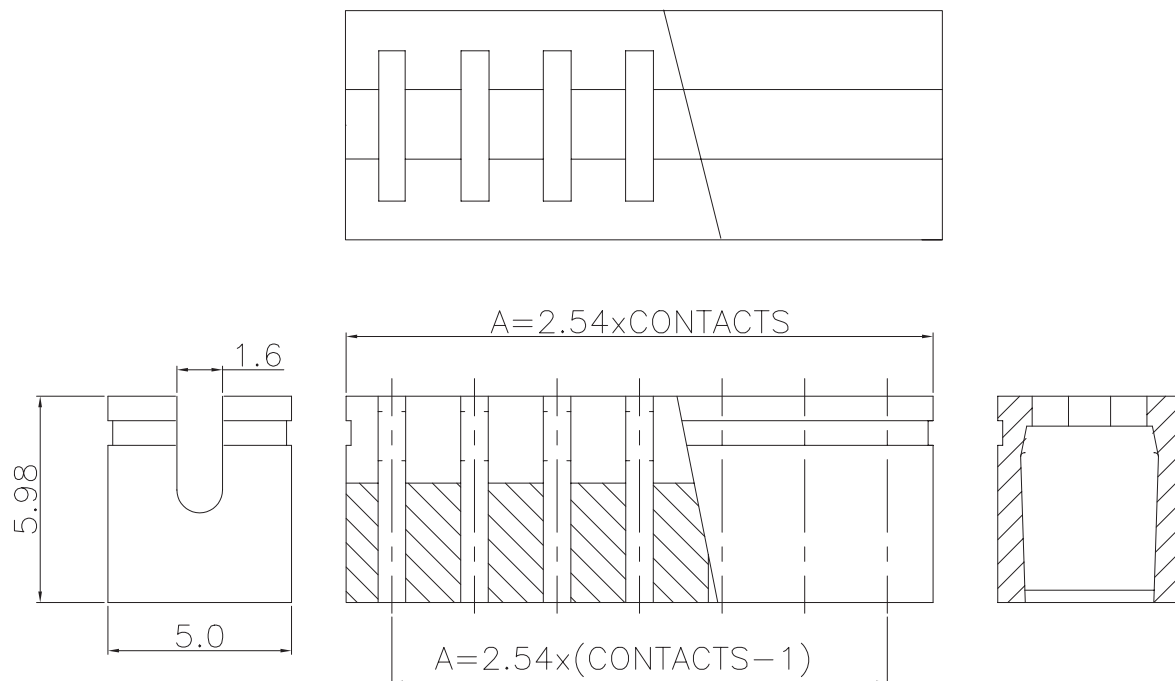

TECHNICAL CHARACTERISTICS

MATERIAL

INSULATOR: PBT
 COLOR: BLACK
 CONTACT MATERIAL: COPPER ALLOY
 CONTACT TYPE: STAMPED
 CONTACT PLATING: GOLD
 QUALITY CLASS: 3 AS PER CECC 75 301-802
 PITCH: 2.54MM

ENVIRONMENTAL

OPERATING TEMPERATURE: -40 UP TO 125°C
 FLAMABILITY RATING: UL94-V0
 COMPLIANCE: LEAD FREE AND ROHS

ELECTRICAL

CURRENT RATING: 3A
 WORKING VOLTAGE: 250V AC
 INSULATOR RESISTANCE: >1000 MOHM
 DIELECTRIC WITHSTANDING VOLTAGE: 650V AC/MN
 CONTACT RESISTANCE: 30 mOHM MAX

PACKAGING

BAG

DIMENSIONS

NB. CIRCUIT	A	B
2	2.54	5.08
3	5.08	7.62
4	7.62	10.16
5	10.16	12.70
6	12.70	15.24
7	15.24	17.78
8	17.78	20.32
9	20.32	22.86
10	22.86	25.40
13	30.48	33.02

RoHS Compliant

PROJECTION:

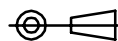

GENERAL TOLERANCE

.X = +/- 0.2

.XX = +/- 0.15



APPROVAL: RJ

UNIT: MM

SCALE:

SHEET: 1/1

DRAW: CEL KING

DESCRIPTION: 2.54MM JUMPER WITH TEST POINT

WERI PART NO: 609 1xx 134 21

SIZE

A4

G							
F							
E							
D							
C							
B							
A	17-DEC-07	PDF	CH				
REV	DATE	FILE	BY				

Mouser Electronics

Authorized Distributor

Click to View Pricing, Inventory, Delivery & Lifecycle Information:

[Wurth Elektronik:](#)

[60910313421](#)