

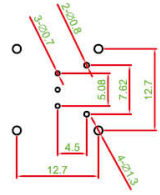

DIMENSION

• PS011A-N11TAA □ □

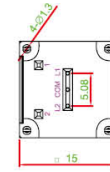
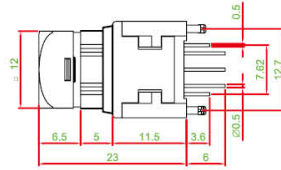
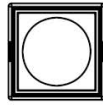

• PS011A-N11TBB □ □

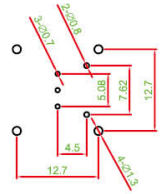
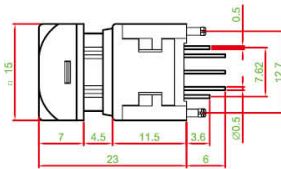
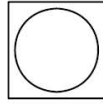

• PS011A-N11TBC □ □

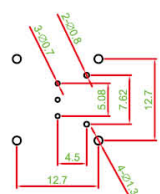
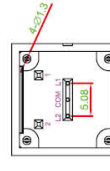
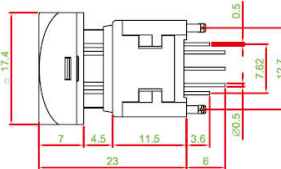
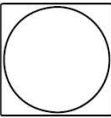

• PS011A-N11TCD □ □

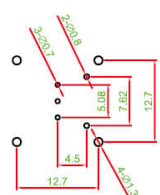
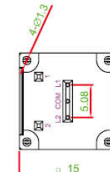
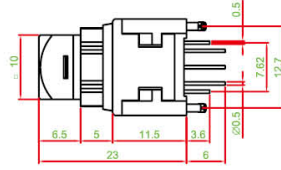
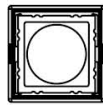

• PS011A-N11TBB-NRGB

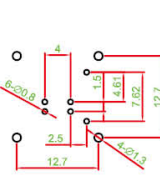
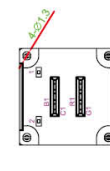
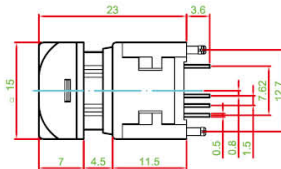
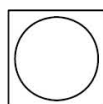

• PS011A-N11TBB-2NRGB

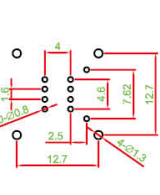
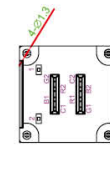
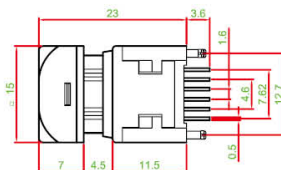
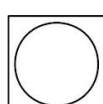

• PS011A-N11TBB-RGB

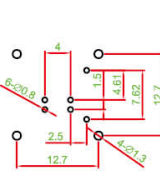
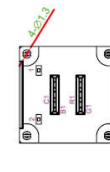
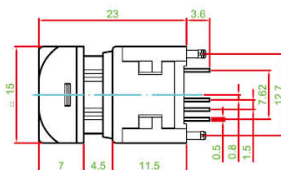
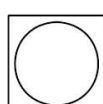

• PS011A-N11TBB-2RGB

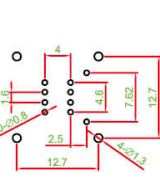
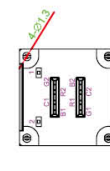
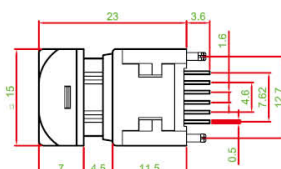
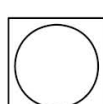

- TACT SWITCH
- PUSH BUTTON SWITCH
- LED TOUCH SENSOR SWITCH
- 5 DIRECTION NAVIGATION SWITCH WITH LED
- MEMBRANE SWITCH
- LED LIGHT BAR
- SLIDE SWITCH
- ROTARY SWITCH
- ROCKER SWITCH
- DETECT SWITCH
- ENCODER
- INTERRUPTER
- MINIATURE MICRO SWITCH
- TELEPHONE HOOK SWITCH
- DOOR SWITCH
- MINI SIZE SOCKET
- KNOB
- CAP SYMBOL



DIMENSION

· PS011A-N11NBE-4NRGB

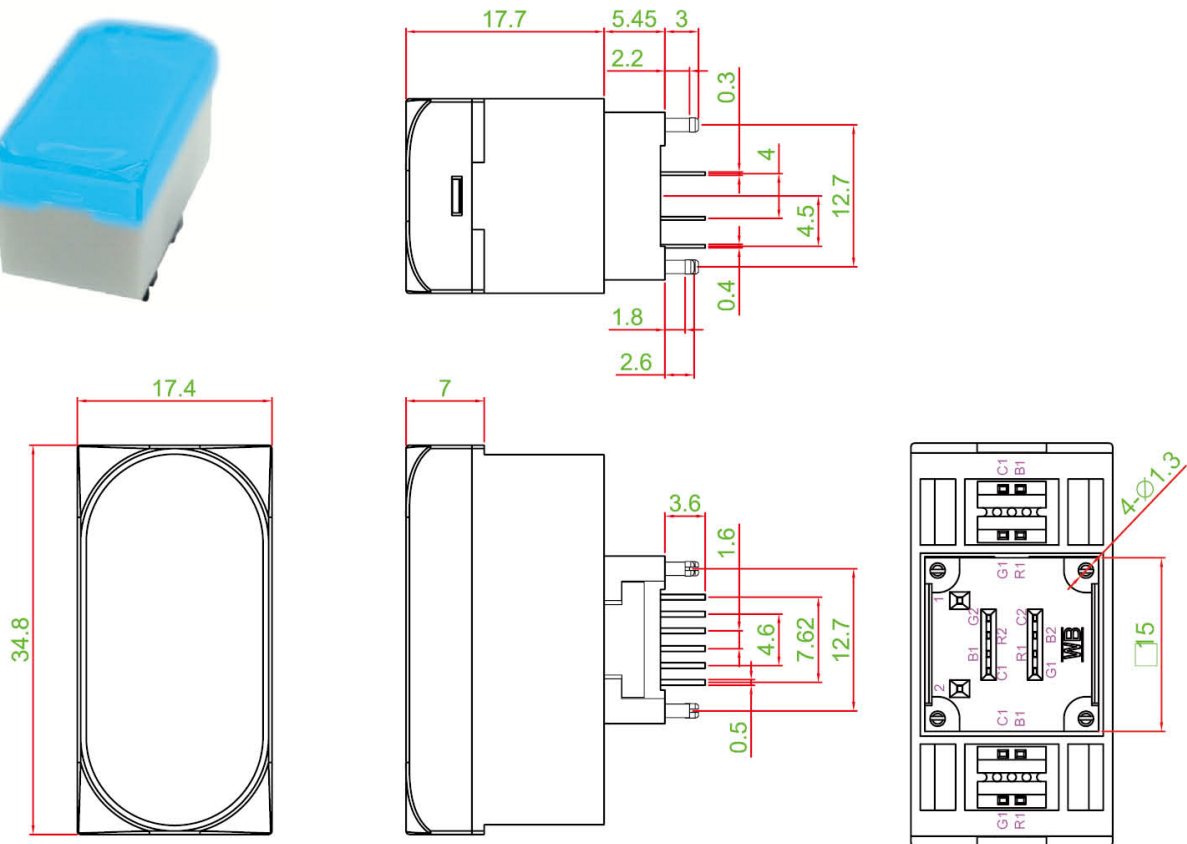

INSTALLATION INSTRUCTIONS

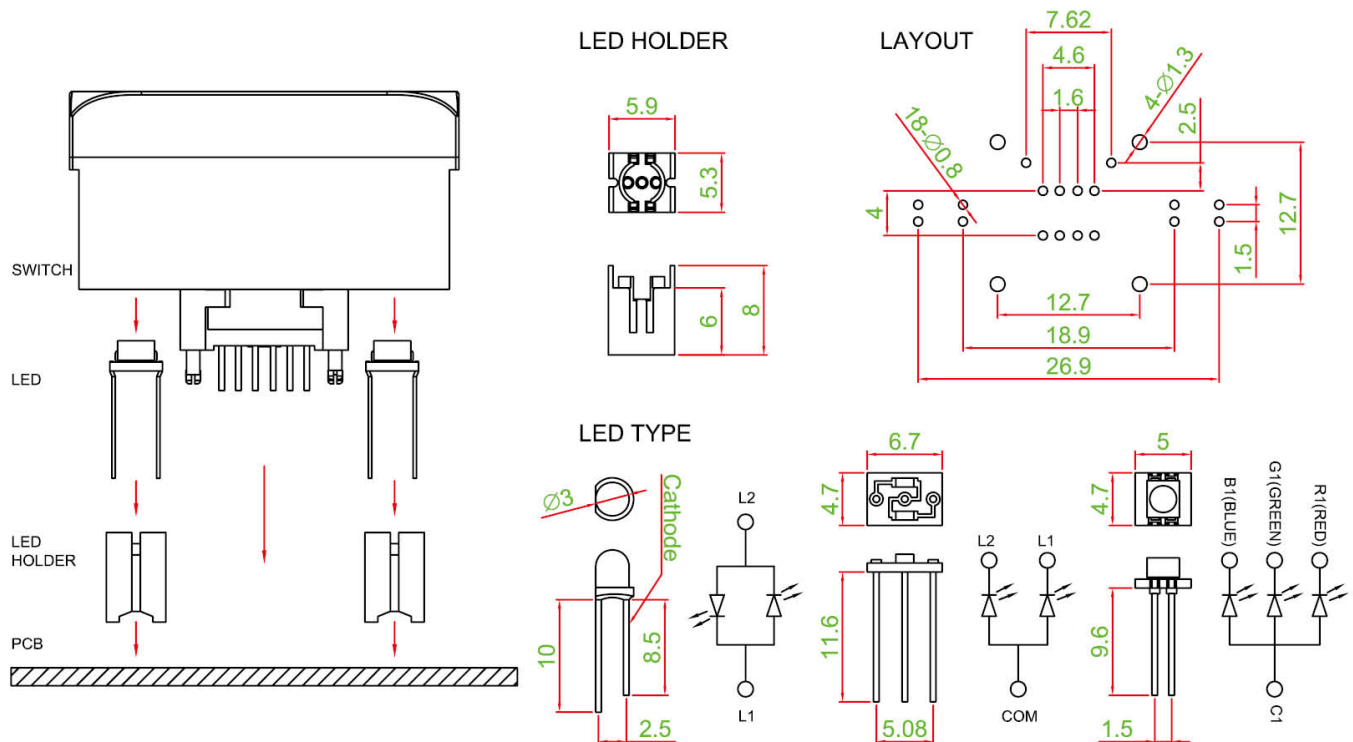

TACT SWITCH

PUSH BUTTON SWITCH

LED TOUCH SENSOR SWITCH

5 DIRECTION NAVIGATION SWITCH WITH LED

MEMBRANE SWITCH

LED LIGHT BAR

SLIDE SWITCH

ROTARY SWITCH

ROCKER SWITCH

DETECT SWITCH

ENCODER

INTERRUPTER

MINIATURE MICRO SWITCH

TELEPHONE HOOK SWITCH

DOOR SWITCH

MINI SIZE SOCKET

KNOB

CAP SYMBOL



TACT SWITCH
PUSH BUTTON SWITCH
LED TOUCH SENSOR SWITCH WITH LED
5 DIRECTION NAVIGATION SWITCH
MEMBRANE SWITCH
LED LIGHT BAR
SLIDE SWITCH
ROTARY SWITCH
ROCKER SWITCH
DETECT SWITCH
ENCODER
INTERRUPTER
MINIATURE MICRO SWITCH
TELEPHONE HOOK SWITCH
DOOR SWITCH
MINI SIZE SOCKET
KNOB
CAP SYMBOL

● PANEL MOUNT TYPE (FOR CAP SIZE A, B AND D TYPE)

· AUTO TYPE

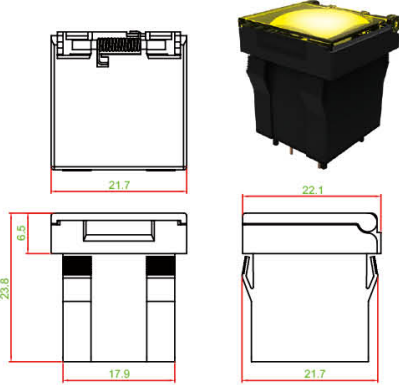

· MANUAL TYPE

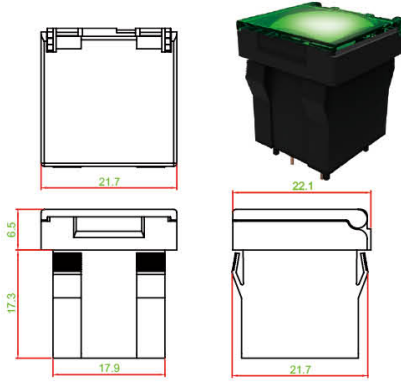

· PANEL CUT OUT

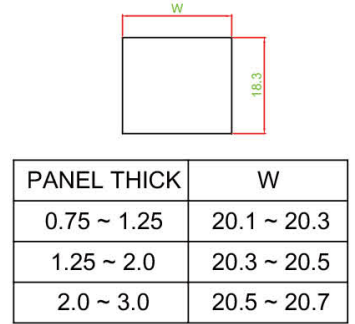

● LOCK TYPE

· PS011A-L11NAA

· PS011A-L11NBB

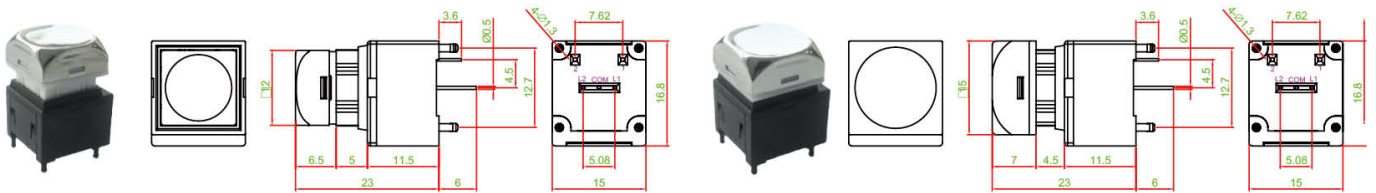

● CAP TYPE

· A1 TYPE

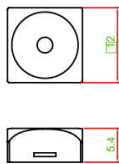

· A2 TYPE



· A3 TYPE

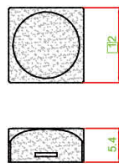

· B1 TYPE

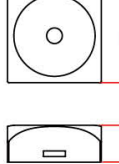

· B2 TYPE

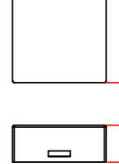

· B3 TYPE

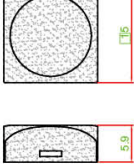

· C1 TYPE

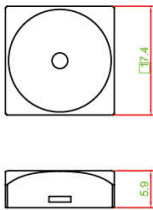

· C2 TYPE

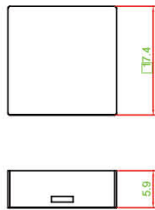

· C3 TYPE

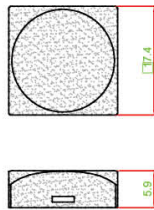

· D1 TYPE



· D2 TYPE



· D3 TYPE

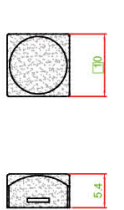

● CIRCUIT

SWITCH

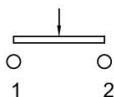

LED

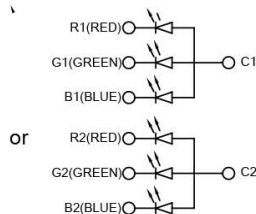
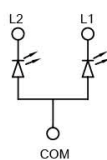

Mouser Electronics

Authorized Distributor

Click to View Pricing, Inventory, Delivery & Lifecycle Information:

[Well Buying:](#)

[PS011A-N11TBCPGUR](#) [PS011A-N11NAX-2NRGB](#) [PS011A-N11NBX-2NRGB](#) [PS011A-N11TAAPGUR](#) [PS011A-N11TBBPGUR](#) [PS011A-N11TBCUWUY](#)