

## BGA THERMAL SOLUTIONS MATRIX

The following table represents Wakefield's recommendations for a variety of standard BGA sizes. However, this is by no means a complete list of components that can be used with these heat sinks. To determine suitability for your particular component, request a BGA heat sink evaluation kit.

BGA Sizes (mm)	Heat Sink Footprint (mm)	Heat Sink Height (inches)				Recommended Series #	Attachment Method
17	17 x 17	.40				D10650	Adhesive
19	19 x 19	1.00				602	Adhesive
21	21 x 21	.40				D10850	Adhesive
21	21 x 21	.25	.35	.45	.60	624	Adhesive
23	22 x 22	.40 .60				604	Adhesive
23	22 x 22	.75				605	Adhesive
25	25 x 25	.25	.35	.45	.60	625	Adhesive
27	28 x 28	.25	.35	.45	.60	658	Adhesive
29	30 x 30	.77				606	Adhesive
31	31 x 28	.65				607	Adhesive
31	31 x 31	.80				611	Adhesive
33	32 x 32	.35	.40			610	Adhesive
35	35 x 35	.65				612	Adhesive
35	35 x 35	.25	.35	.45	.60	642	Adhesive
35	35 x 35	.25	.35	.45	.60	630	Adhesive
37.5	37 x 37	.50				613	Adhesive
37.5	37 x 37	.65				659	Adhesive
45.7 x 35.5	37 x 47	.80				617	Adhesive
40	38 x 38	.30	.50	1.00		614	Adhesive
37.5	38 x 38	.29				660	Adhesive
40	40 x 28	.35				643	Clip
40	40 x 40	.26	.53			655	Adhesive
42.5	41 x 41	.41				615	Adhesive
45	43 x 43	.20	.25	.35	.45 .60	628	Adhesive
45	43 x 43	.15				662	Adhesive
47.5	47 x 47	.80				616	Adhesive
50	50 x 50	.40	.65	.80	1.00	698	Adhesive
50	51 x 51	.20 1.00				618	Adhesive
50	52 x 51	.80				622	Adhesive
50	53 x 47	.40	.65	.80	1.00	798	Adhesive
50	64 x 51	.24				620	Adhesive
up to 45	73 x 50	.50 1.00				609	Clip
up to 45	73 x 50	.95				619	Clip

### RoHS COMPLIANCE

Please note that Wakefield part numbers designated with an "E" in this catalog denote new parts in compliance with the RoHS initiative, with the exception of our Precision Clamps. Wakefield will still continue to offer non-RoHS compliant versions of these parts. Please be aware that many Wakefield Standard parts have always been compliant since their design inception and therefore will not carry the "E" designation.

Wakefield requests that you refer to the RoHS compliance tool on our website at [www.wakefield.com](http://www.wakefield.com) to verify RoHS compliance. If you require further clarification or information regarding RoHS, please contact the factory.

## THERMAL INTERFACE MATERIAL PART NUMBER GUIDE

All of the heat sinks shown in this catalog are available with any of the following thermal tape and interface materials, pre-applied at the factory. Use the “T” series, thermally enhanced, pressure sensitive adhesives to attach the heat sink to the electronic package and provide a good thermal link to the heat sink. The “S” series interface materials have adhesives on only one side, for pre-attachment to the heat sink, and provide superior thermal performance. Specify these materials in applications where the heat sink will be fixed to the electronic package by some mechanical means other than a tape. Please note that none of these materials are for use in applications requiring electrical isolation from the electronic device. All options other than -T1 and -T4 are RoHS compliant.

Note: To obtain the estimated thermal resistance of the interface material in your application, divide the thermal impedance value by the area of the pad in square inches. For example, a 2” x 2” piece of T4 has a resistance of  $1.10 \text{ C-in}^2/\text{W} \div 4 \text{ in}^2 = 0.275 \text{ C/W}$

### “T” SERIES THERMALLY ENHANCED PRESSURE SENSITIVE ADHESIVES

Suffix	Manufacturer Product	Thermal Impedance C-in <sup>2</sup> /W	Thickness, Inches	Package Surface, Comments
-T1	Chomerics, T405	0.47	0.006	Metal/ceramic; aluminum carrier
-T1E	Chomerics, T405R	0.47	0.006	RoHS-compliant version of -T1
-T3	Chomerics, T412	0.25	0.009	Metal/ceramic; very good performance and conformity
-T4	Chomerics, T410	1.10	0.007	Plastic
-T4E	Chomerics, T410R	1.10	0.007	RoHS-compliant version of -T4
-T5	Chomerics, T411	1.00	0.011	Plastic; conforms to out-of-flat packages
-T6	3M, 8810	0.88	0.010	Metal/ceramic; very good adhesion and conformity
-T7	Bergquist, BP 108	1.28	0.008	Metal/ceramic; electrically insulating

### “S” SERIES THERMAL INTERFACE PADS

Suffix	Manufacturer Product	Thermal Impedance C-in <sup>2</sup> /W	Thickness, Inches	Package Surface, Comments
-S4	Berquist Softface	0.06	0.005	All surfaces; requires mechanical fasteners

## ORDERING INFORMATION

Once you have chosen heat sink and thermal interface material that meets your thermal & mechanical requirements it is easy to designate the part number. Simply add the interface material suffix referenced on the chart above to the base part number for the heat sink. The base part number already includes information regarding its size and finish.

Example:

To order the 658 Series heat sink at .350” tall with the T5 thermal interface material, specify part number:

658-35AB - T5

## HEAT SINKS FOR BGAs, SUPER BGAs, PBGAs, and FPBGAs

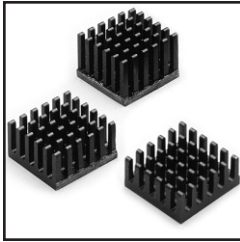

### 624 SERIES Omnidirectional Pin Fin Heat Sink for BGAs

Standard P/N	Base Dimensions in. Sq.	Fin Height "A" in. (mm)	Typical Applications	Weight lbs. (grams)
624-25AB	.827 (21)	.250 (6.4)	21mm BGA	.009 (4.09)
624-35AB	.827 (21)	.350 (8.9)	21mm BGA	.011 (4.99)
624-45AB	.827 (21)	.450 (11.4)	21mm BGA	.015 (6.81)
624-60AB	.827 (21)	.600 (15.2)	21mm BGA	.026 (11.80)

Material: Aluminum, Black Anodized

The 624 Series is an omnidirectional pin fin heat sink for both natural and forced-convection applications.

Applications include network routers and switches, high-resolution printers, digital cameras, consumer video games, digital video disks (DVD) and global positioning systems (GPS).

#### PRODUCT FEATURES

- Available in four standard heights, .25 inch, .35 inch, .45 inch, and .60 inch.
- Available with pressure sensitive adhesives for quick and easy mounting. See Page 3

#### MECHANICAL DIMENSIONS

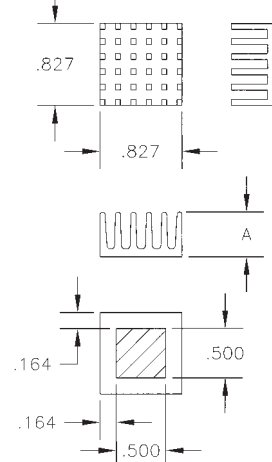

#### 624 SERIES

#### 624 THERMAL PERFORMANCE

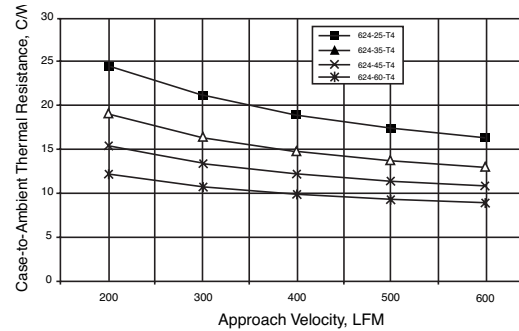

Dimensions: in.

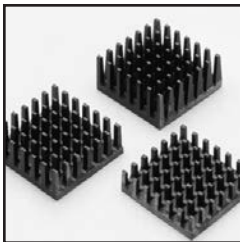

### 625 SERIES Omnidirectional Pin Fin Heat Sink for BGAs

Standard P/N	Base Dimensions in. Sq.	Fin Height "A" in. (mm)	Typical Applications	Weight lbs. (grams)
625-25AB	.984 (25)	0.250 (6.4)	25 mm BGA	.012 (5.45)
625-35AB	.984 (25)	0.350 (8.9)	25 mm BGA	.014 (6.36)
625-45AB	.984 (25)	0.450 (11.4)	25 mm BGA	.018 (8.17)
625-60AB	.984 (25)	0.600 (15.2)	25 mm BGA	.030 (13.62)

Material: Aluminum, Black Anodized

The 625 Series is an omnidirectional pin fin heat sink for both natural and forced-convection applications.

Applications include network routers and switches, high-resolution printers, digital cameras, consumer video games, digital video disks (DVD) and global positioning systems (GPS).

#### PRODUCT FEATURES

- Available in four standard heights, .25 inch, .35 inch, .45 inch, and .60 inch.
- Available with pressure sensitive adhesives for quick and easy mounting. See Page 3

#### MECHANICAL DIMENSIONS

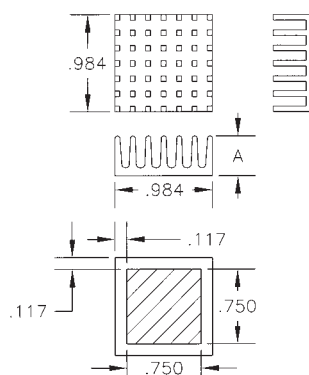

#### 625 SERIES

#### 625 THERMAL PERFORMANCE

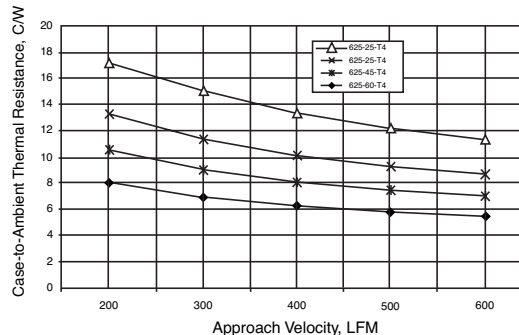

Dimensions: in.

HEAT SINKS FOR BGAs, SUPER BGAs, PBGAs, and FPBGAs



**659 SERIES** Unidirectional Fin Heat Sink for BGAs

Standard P/N	Base Dimensions in. (mm)	Height in. (mm)	Typical Application	Heat Sink Finish	Weight lbs. (grams)
659-65AB	1.45 (36.8) sq	0.650 (16.5)	37mm BGA	Black Anodized	0.050 (22.68)

Notes: 1. Optional factory preapplied pressure-sensitive adhesive. See Page 3

MECHANICAL DIMENSIONS

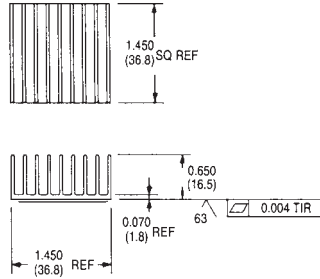

Dimensions: in. (mm)

NATURAL AND FORCED CONVECTION CHARACTERISTICS

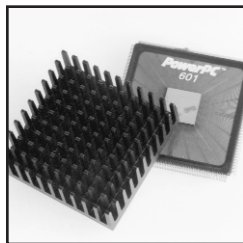
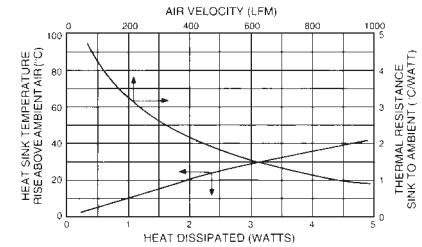

**655 SERIES** Omnidirectional Pin Fin Heat Sink for BGAs and PowerPC™

Standard P/N	Base Dimensions in. (mm)	Dimension "A" in. (mm)	Dimension "B" in. (mm)	Typical Applications	Heat Sink Finish	Weight lbs. (grams)
655-26AB	1.600 (40.6) sq	0.260 (6.6)	0.125 (3.2)	40mm BGA	Black Anodized	0.038 (17.01)
655-53AB	1.600 (40.6) sq	0.525 (13.3)	0.145 (3.7)	40mm BGA	Black Anodized	0.050 (22.68)

Notes: 1. Optional factory preapplied pressure-sensitive adhesive. See Page 3

MECHANICAL DIMENSIONS

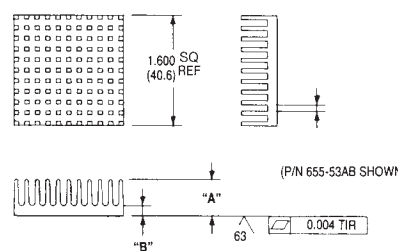

Dimensions: in. (mm)

NATURAL AND FORCED CONVECTION CHARACTERISTICS

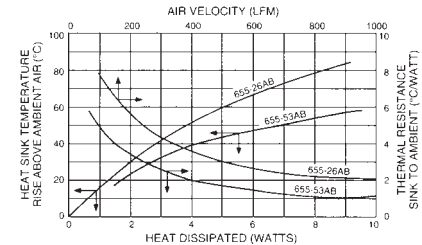

**658 SERIES** Omnidirectional Pin Fin Heat Sink for BGAs and PowerPC™

Standard P/N	Base Dimensions in. (mm)	Dimension "A" in. (mm)	Typical Applications	Heat Sink Finish	Weight lbs. (grams)
658-25AB	1.100 (27.9) sq	0.250 (6.4)	27mm BGA	Black Anodized	0.013 (5.67)
658-35AB	1.100 (27.9) sq	0.350 (8.9)	27mm BGA	Black Anodized	0.015 (6.70)
658-45AB	1.100 (27.9) sq	0.450 (11.4)	27mm BGA	Black Anodized	0.019 (8.50)
658-60AB	1.100 (27.9) sq	0.600 (15.2)	27mm BGA	Black Anodized	0.031 (14.17)

Notes: 1. Optional factory preapplied pressure-sensitive adhesive. See Page 3

MECHANICAL DIMENSIONS

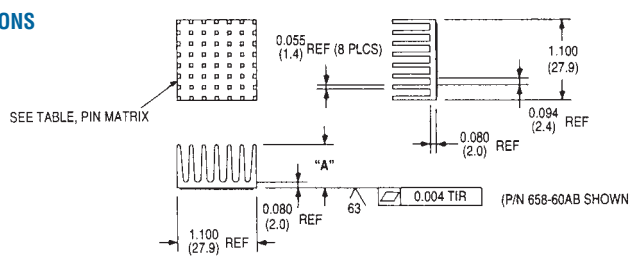

Dimensions: in. (mm)

NATURAL AND FORCED CONVECTION CHARACTERISTICS

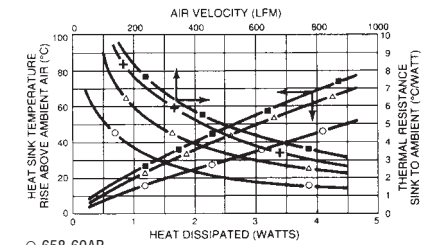

KEY: ■ 658-25AB + 658-35AB △ 658-45AB ○ 658-60AB

## HEAT SINKS FOR BGAs, SUPER BGAs, PBGAs, and FPBGAs

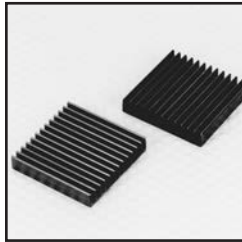

### 660 SERIES Unidirectional Fin Heat Sink for BGAs

Standard P/N	Base Dimensions in. (mm)	Height in. (mm)	Typical Application	Heat Sink Finish	Weight lbs. (grams)
660-29AB	1.530SQ. (38.9)SQ.	0.285 (7.2)	37mm BGA	Black Anodized	0.031 (14.17)

Notes: 1. Optional factory preapplied pressure-sensitive adhesive. See Page 3

#### MECHANICAL DIMENSIONS

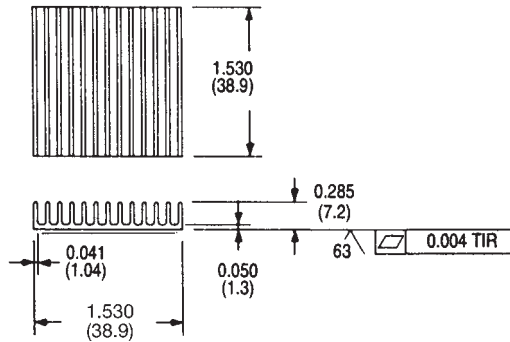

Dimensions: in. (mm)

#### NATURAL AND FORCED CONVECTION CHARACTERISTICS

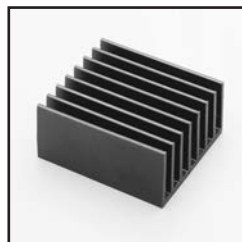
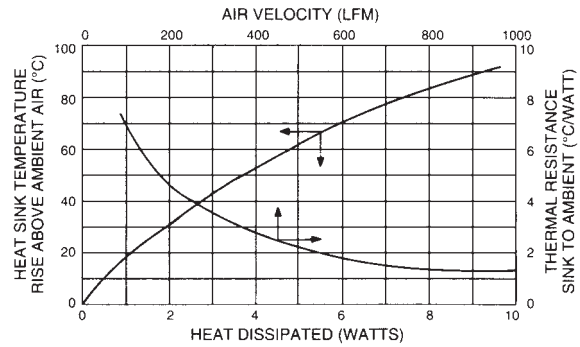

### 642 SERIES Unidirectional Pin Fin Heat Sink for BGAs

Standard P/N	Base Dimensions in. Sq.	Fin Height "A" in. (mm)	Typical Applications	Weight lbs. (grams)
642-25AB	1.378 (35)	.250 (6.4)	35 mm BGA	.022 (9.99)
642-35AB	1.378 (35)	.350 (8.9)	35 mm BGA	.027 (12.26)
642-45AB	1.378 (35)	.450 (11.4)	35 mm BGA	.031 (14.07)
642-60AB	1.378 (35)	.600 (15.2)	35 mm BGA	.039 (17.71)

Material: Aluminum, Black Anodized

The 642 Series is an unidirectional pin fin heat sink for both natural and forced-convection applications.

Applications include network routers and switches, high-resolution printers, digital cameras, consumer video games, digital video disks (DVD) and global positioning systems (GPS).

#### PRODUCT FEATURES

- Available in four standard heights, .25 inch, .35 inch, .45 inch, and .60 inch.
- Available with pressure sensitive adhesives for quick and easy mounting. See Page 3

#### MECHANICAL DIMENSIONS

#### 642 SERIES

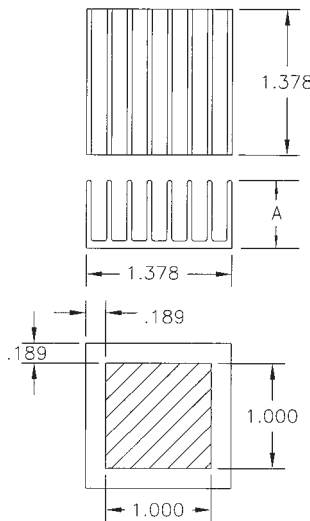

Dimensions: in. (mm)

#### 642 THERMAL PERFORMANCE

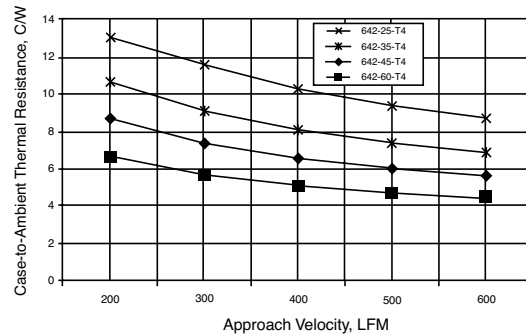

Performance shown is with T4 thermal adhesive applied.

## HEAT SINKS FOR BGAs, SUPER BGAs, PBGAs, and FPBGAs

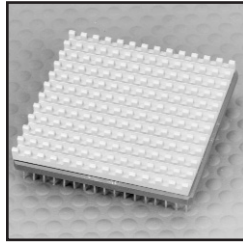

### 662 SERIES Omnidirectional Pin Fin Heat Sink for Limited Height BGAs

Standard P/N	Base Dimensions in. (mm)	Height in. (mm)	Typical Applications	Heat Sink Finish	Weight lbs. (grams)
662-15AG	1.713 (43.5) sq	0.150 (3.8)	45mm BGA	Gold Iridite	0.019 (8.50)
662-15AB	1.713 (43.5) sq	0.150 (3.8)	45mm BGA	Black Anodized	0.019 (8.50)

Notes: 1. Optional factory preapplied pressure-sensitive adhesive. See Page 3

#### MECHANICAL DIMENSIONS

12 x 14 PINS

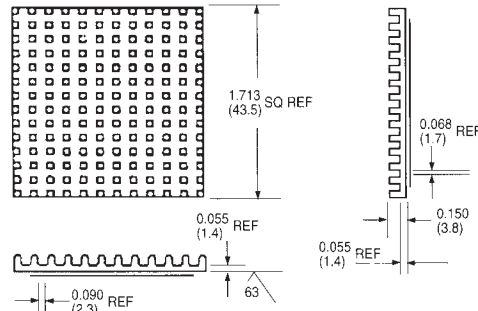

#### NATURAL AND FORCED CONVECTION CHARACTERISTICS

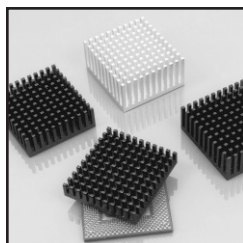
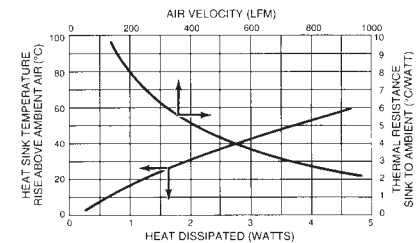

### 628 SERIES Omnidirectional Pin Fin Heat Sink for BGAs

Standard P/N	Base Dimensions in. (mm)	Dimensions "A" in. (mm)	Typical Applications	Heat Sink Finish	Weight lbs. (grams)
628-20AB	1.750 (44.5) x 1.700 (43.2)	0.200 (5.1)	45mm BGA	Black Anodized	0.031 (14.17)
628-25AB	1.750 (44.5) x 1.700 (43.2)	0.250 (6.4)	45mm BGA	Black Anodized	0.038 (17.01)
628-35AB	1.750 (44.5) x 1.700 (43.2)	0.350 (8.9)	45mm BGA	Black Anodized	0.044 (19.84)
628-40AB	1.750 (44.5) x 1.700 (43.2)	0.400 (10.2)	45mm BGA	Black Anodized	0.050 (22.68)
628-65AB	1.750 (44.5) x 1.700 (43.2)	0.650 (16.5)	45mm BGA	Black Anodized	0.056 (25.51)

Notes: 1. Optional factory preapplied pressure-sensitive adhesive. See Page 3

#### MECHANICAL DIMENSIONS

11 x 10 PINS

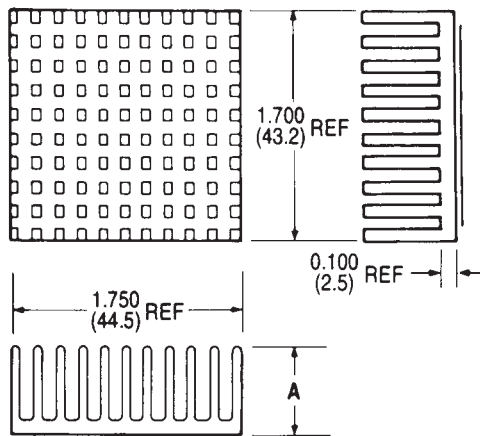

#### NATURAL CONVECTION CHARACTERISTICS

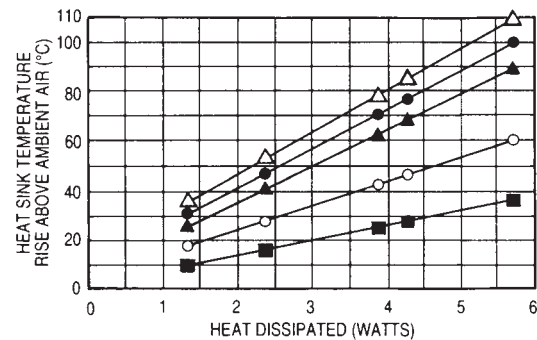

#### FORCED CONVECTION CHARACTERISTICS

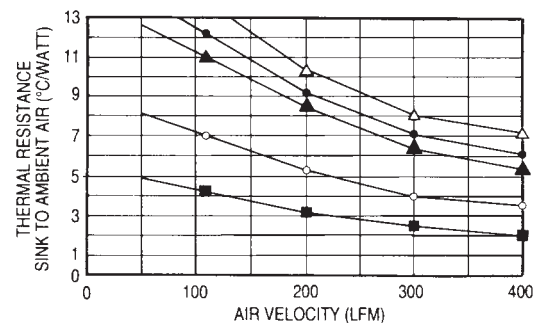

KEY: △ 628-20AB ● 628-25AB ▲ 628-35AB ○ 628-40AB ■ 628-65AB



## HEAT SINKS FOR BGAs, SUPER BGAs, PBGAs, and FPBGAs

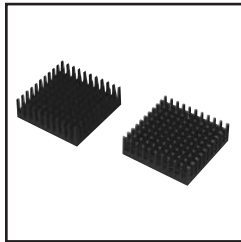

### 630 SERIES Omnidirectional Pin Fin Heat Sink for BGAs

Standard P/N	Base Dimensions in. Sq.	Fin Height "A" in. (mm)	Typical Applications	Weight lbs. (grams)
630-25AB	1.378 (35)	.250 (6.4)	35mm BGA	.009 (4.09)
630-35AB	1.378 (35)	.350 (8.9)	35mm BGA	.011 (4.99)
630-45AB	1.378 (35)	.450 (11.4)	35mm BGA	.015 (6.81)
630-60AB	1.378 (35)	.600 (15.2)	35mm BGA	.026 (11.80)

Material: Aluminum, Black Anodized

The 630 Series is an omnidirectional pin fin heat sink for both natural and forced-convection applications.

Applications include network routers and switches, high-resolution printers, digital cameras, consumer video games, digital video disks (DVD) and global positioning systems (GPS).

#### PRODUCT FEATURES

- Available in four standard heights, .25 inch, .35 inch, .45 inch, and .60 inch.
- Available with pressure sensitive adhesives for quick and easy mounting. See Page 3

#### MECHANICAL DIMENSIONS

#### 630 SERIES

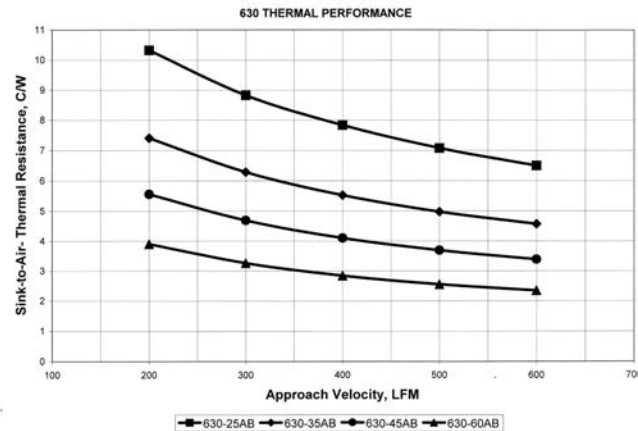
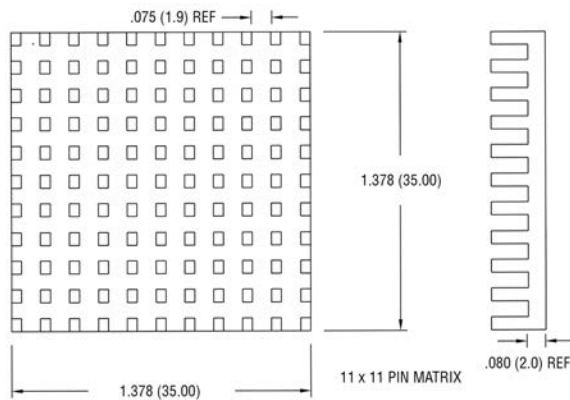

Dimensions: in.

## HEAT SINKS FOR BGAs, SUPER BGAs, PBGAs, and FPBGAs

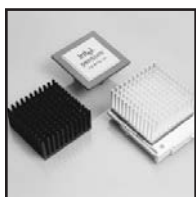

### 698 SERIES Omnidirectional Pin Fin Heat Sink For BGAs

Standard P/N	Base Dimensions in. (mm)	Dimensions "A" in. (mm)	Typical Applications	Heat Sink Finish	Weight lbs. (grams)
698-40AB	2.100 (53.3) sq.	0.400 (10.2) sq.	45mm BGA	Black Anodized	0.075 (34.02)
698-65AB	2.100 (53.3) sq.	0.650 (16.5) sq.	45mm BGA	Black Anodized	0.119 (53.86)
698-80AB	2.100 (53.3) sq.	0.800 (20.3) sq.	45mm BGA	Black Anodized	0.125 (56.70)
698-100AB	2.100 (53.3) sq.	1.000 (25.4) sq.	45mm BGA	Black Anodized	0.144 (65.20)

Notes: 1. Optional factory preapplied pressure-sensitive adhesive. See Page 3

#### MECHANICAL DIMENSIONS

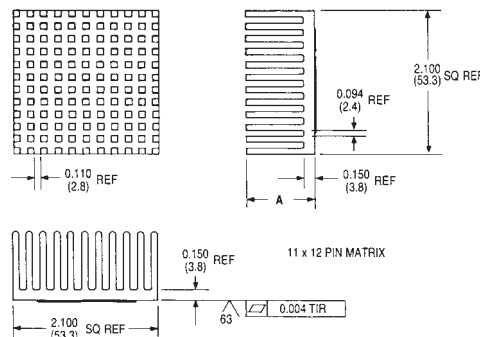

Dimensions: in. (mm)

#### FORCED CONVECTION THERMAL PERFORMANCE DATA (FLOW PARALLEL TO EXTRUSION DIRECTION)

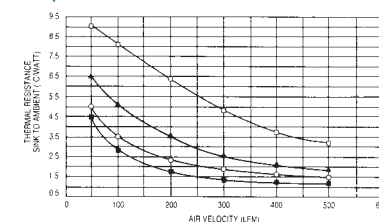

KEY: □ 698-40AB ▲ 698-65AB ○ 698-80AB ■ 698-100AB

## HEAT SINKS FOR BGAs, SUPER BGAs, PBGAs, and FPBGAs

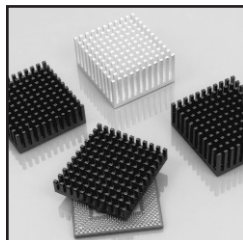

### 798 SERIES Pin Fin Heat Sink for BGAs

Standard P/N	Base Dimensions in. (mm)	Dimensions "A" in. (mm)	Typical Applications	Heat Sink Finish	Weight lbs. (grams)
798-40AB	2.100 (53.3) x 1.860 (47.2)	0.400 (10.2)	45mm BGA	Black Anodized	0.063 (28.35)
798-65AB	2.100 (53.3) x 1.860 (47.2)	0.650 (16.5)	45mm BGA	Black Anodized	0.106 (48.19)
798-80AB	2.100 (53.3) x 1.860 (47.2)	0.800 (20.3)	45mm BGA	Black Anodized	0.113 (51.03)
798-100AB	2.100 (53.3) x 1.860 (47.2)	1.000 (25.4)	45mm BGA	Black Anodized	0.131 (59.53)

### MECHANICAL DIMENSIONS

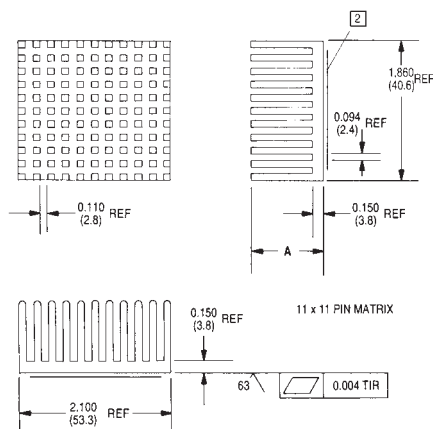

Dimensions: in. (mm)

### FORCED CONVECTION THERMAL PERFORMANCE DATA (FLOW PARALLEL TO EXTRUSION DIRECTION)

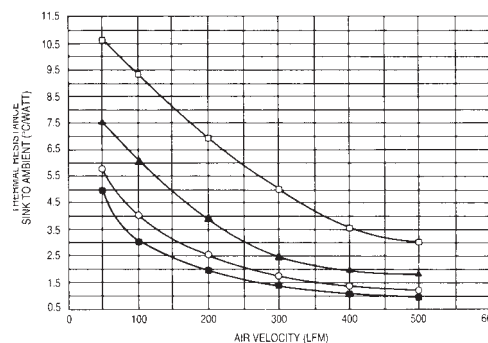

KEY: □ 798-40AB ▲ 798-65AB ○ 798-80AB ■ 798-100AB

- Notes:  
 1. Heat sink mounting surface flatness: 0.004" TIR  
 2. Optional factory preapplied pressure-sensitive adhesive. See Page 3

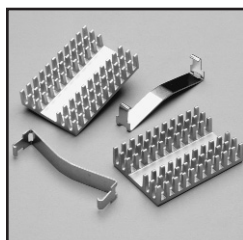

### 643 SERIES Omnidirectional Pin Fin Heat Sink for BGAs

Standard P/N	Base Dimensions in. (mm)	Fin Height in. (mm)	Typical Applications	Weight lbs. (grams)
643-35AP	1.60 (40.64) x 1.10 (27.94)	0.350 (8.89)	40 mm BGA	.070 (31.78)

Material: Aluminum, Plain Finish

The Series 643-35AP is an omnidirectional pin fin heat sink for both natural and forced-convection applications designed to fit a 40 mm BGA.

Applications include network routers and switches, high-resolution printers, digital cameras, consumer video games, digital video disks (DVD) and global positioning systems (GPS).

### PRODUCT FEATURES

- Available with pressure sensitive adhesives to ensure good thermal performance. See page 3
- Can be ordered with the 829SC clip. Order clip separately. (Clip cannot be purchased without heat sink)

### MECHANICAL DIMENSIONS

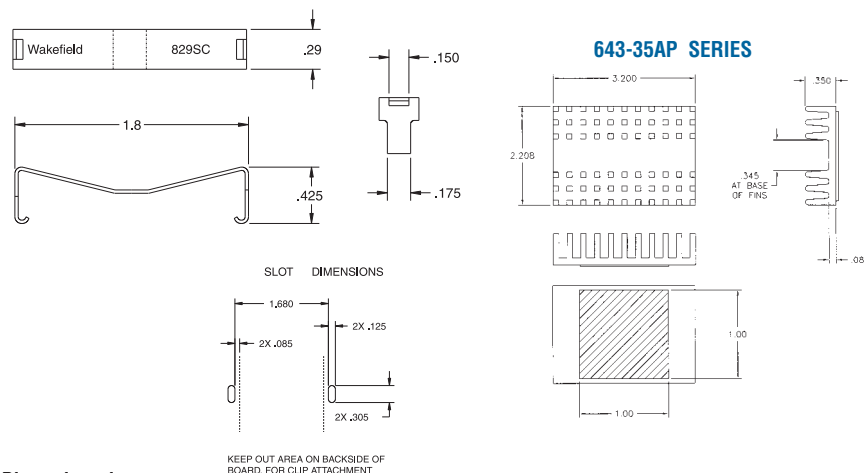

Dimensions: in.

### 643 THERMAL PERFORMANCE

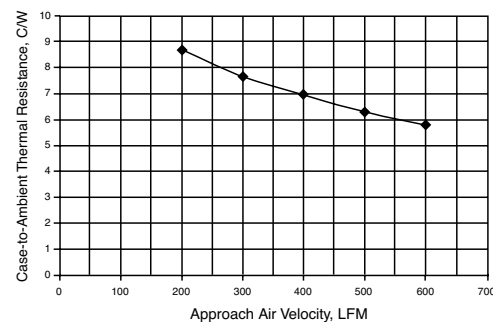

Performance shown is with S5 interface material applied.



## DELTEM™ COMPOSITE HEAT SINKS FOR BGAs

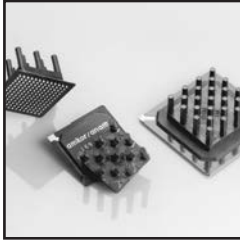

**Deltem™ D10650-40** Pin Fin Heat Sink

Standard P/N	Base Dimensions in. (mm)	Height in. (mm)	Weight lbs. (grams)
D10650-40	0.650 (16.5) sq	0.400 (10.2)	0.004 (1.91)

*Notes: Available with pressure sensitive adhesives for quick and easy mounting. See Page 3*

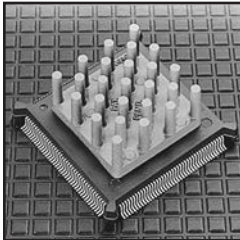

**Deltem™ D10850-40** Pin Fin Heat Sink

Standard P/N	Base Dimensions in. (mm)	Height in. (mm)	Typical Applications	Weight lbs. (grams)
D10850-40	0.850 (21.6) sq	0.400 (10.2)	21mm BGA	0.006 (3.9)

*Notes: Available with pressure sensitive adhesives for quick and easy mounting. See Page 3*

### MECHANICAL DIMENSIONS

**DELTEM™ D10650-40 PIN FIN HEAT SINK**

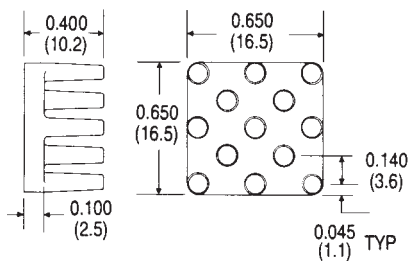

**NATURAL AND FORCED CONVECTION CHARACTERISTICS**

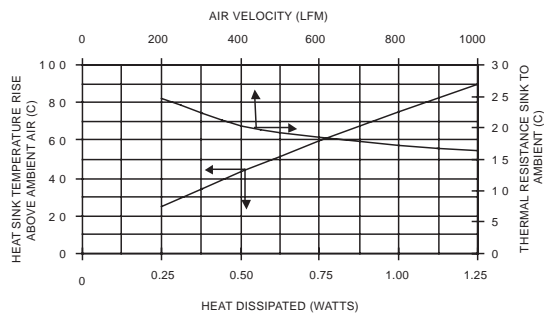

Dimensions: in. (mm)

**DELTEM™ D10850-40 PIN FIN HEAT SINK**

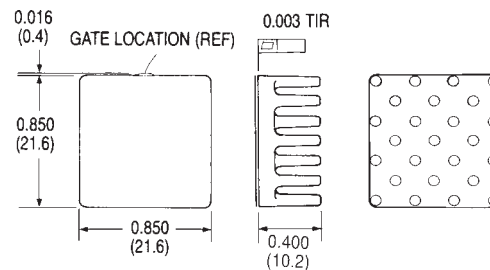

**NATURAL AND FORCED CONVECTION CHARACTERISTICS**

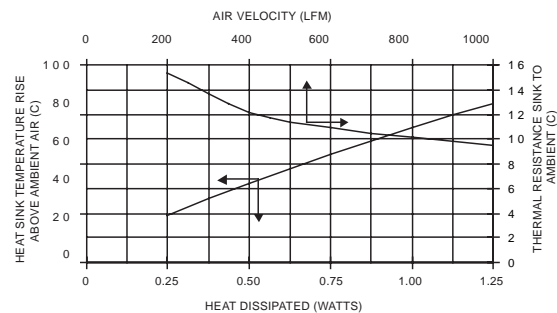

HEAT SINKS FOR BGAs, SUPER BGAs, PBGAs, and FPBGAs

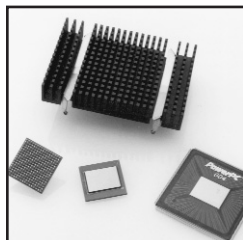

**609 SERIES** Pin Fin Heat Sink/Clip Assembly for BGAs and PowerPC™ Packages

Standard P/N	Base Dimensions in. (mm)	Dimensions "A" in. (mm)	Typical Applications	Heat Sink Finish	Weight lbs. (grams)
609-50AB	2.895 (73.5) x 2.000 (50.8)	0.500 (12.7)	40&45mm BGA	Black Anodized	0.094 (42.5)
609-100AB	2.808 (71.32) x 1.700 (43.2)	1.00 (25.4)	40&45mm BGA	Black Anodized	0.130 (59.0)

Note: Optional factory preapplied thermal interface material.  
 S3 (Bergquist Q-Pad 3, 0.14 °C in<sup>2</sup>/w)  
 S4 (Bergquist Softface, 0.07 °C in<sup>2</sup>/w)

MECHANICAL DIMENSIONS

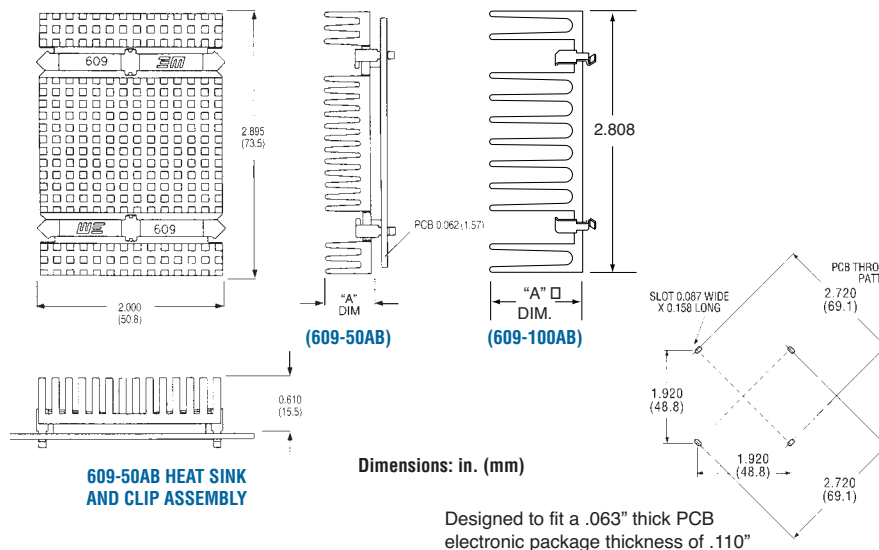

FORCED CONVECTION THERMAL PERFORMANCE DATA (FLOW PARALLEL TO EXTRUSION DIRECTION)

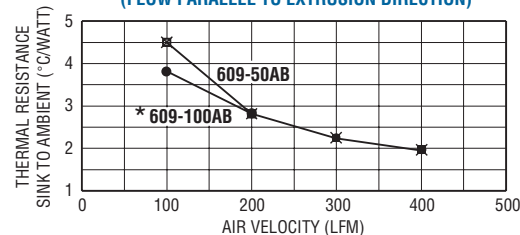

\*Performance is for shrouded conditions. 609-100 will perform better than 609-50 in cases with bypass.

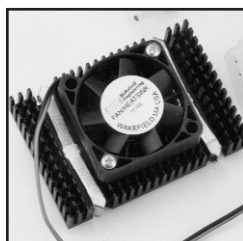

**619 SERIES** Fan Heat Sink for BGA and PowerPC™ Packages

Standard P/N	Base Dimensions in. (mm)	Height in. (mm)	Typical Applications	Heat Sink Finish	Thermal Performance	Weight lbs. (grams)
61995AB124D1	2.871 (72.92) x 1.98 (50.29)	0.953 (24.21)	40&45mm BGA	Black Anodized	1.2° C/W	.150 (68.10)
61995AB054D1	2.871 (72.92) x 1.98 (50.29)	0.953 (24.21)	40&45mm BGA	Black Anodized	1.2° C/W	.150 (68.10)

Note: Optional factory preapplied thermal interface material. See 609 series.

FEATURES AND BENEFITS:

- Captivated clips for ease of assembly
- Low acoustic noise
- Impingement air flow
- Accommodates BGA packages up to 45 mm in size

MECHANICAL DIMENSIONS

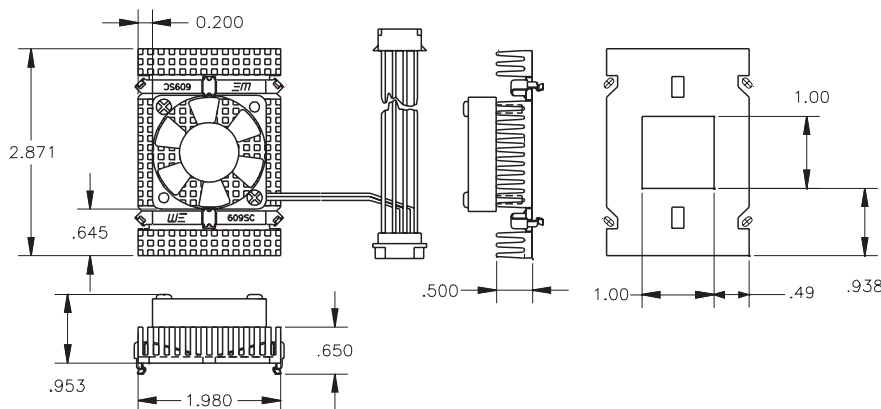

## HEAT SINKS FOR BGAs, SUPER BGAs, PBGAs, and FPBGAs



**602 SERIES** Unidirectional Fin Heat Sink for BGAs

Standard P/N	Base Dimensions in. (mm)	Height in. (mm)	Heat Sink Finish	Weight lbs. (grams)
602-100AP	.750 (19.1) sq	1.000 (25.4)	Plain	.021 (9.59)

Material: Aluminum, Plain Finish

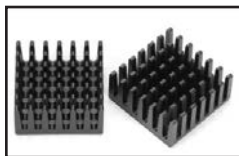
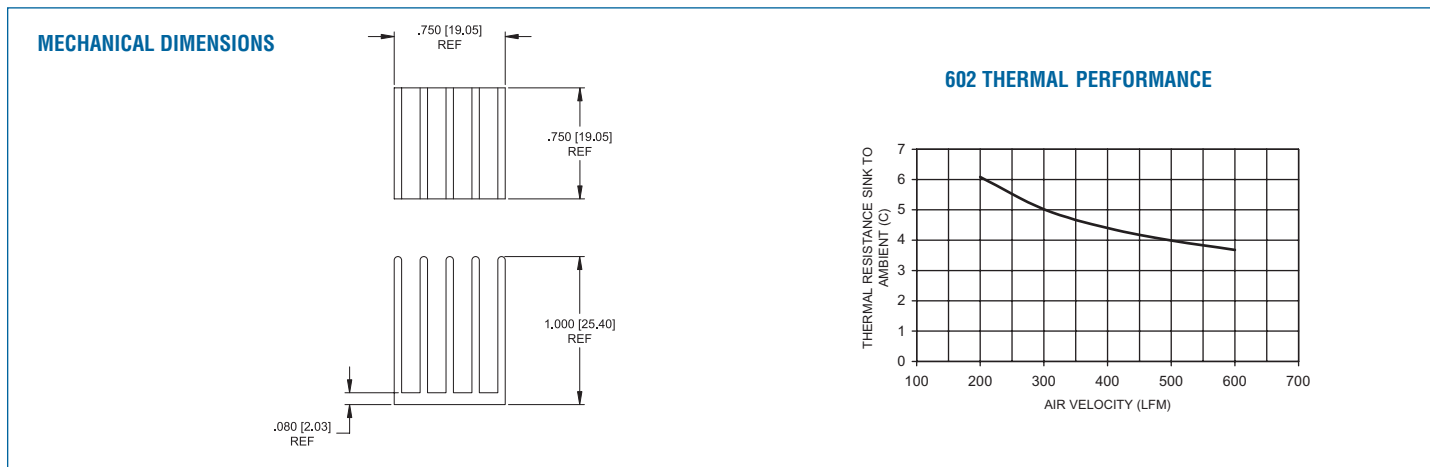

**604 SERIES** Omnidirectional Pin Fin Heat Sink for BGAs

Standard P/N	Base Dimensions in. (mm)	Height in. (mm)	Heat Sink Finish	Weight lbs. (grams)
604-40AB	.850 (21.6) sq	.400 (10.2)	Black Anodized	.012 (5.60)
604-60AB	.850 (21.6) sq	.600 (15.2)	Black Anodized	.016 (7.47)

Material: Aluminum, Black Anodized

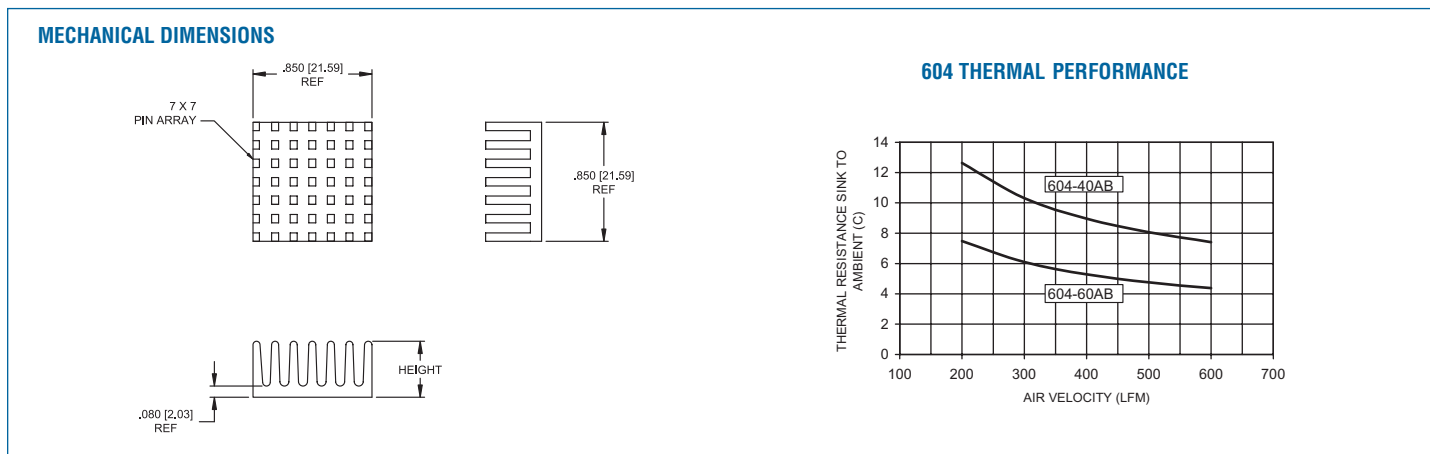

## HEAT SINKS FOR BGAs, SUPER BGAs, PBGAs, and FPBGAs



**605 SERIES** Unidirectional Fin Heat Sink for BGAs

Standard P/N	Base Dimensions in. (mm)	Height in. (mm)	Heat Sink Finish	Weight lbs. (grams)
605-75AB	.880 (22.4) sq	.750 (19.1)	Black Anodized	.030 (13.5)

Material: Aluminum, Black Anodized

### MECHANICAL DIMENSIONS

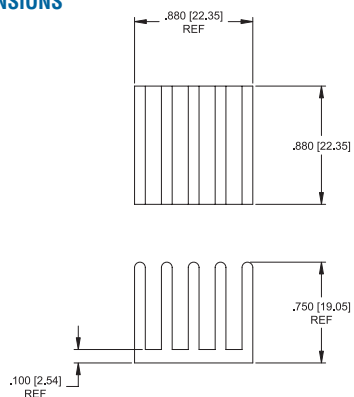

### 605 THERMAL PERFORMANCE

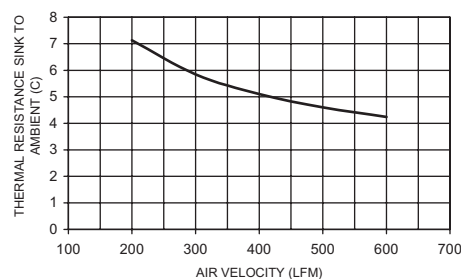

**606 SERIES** Unidirectional Fin Heat Sink for BGAs

Standard P/N	Base Dimensions in. (mm)	Height in. (mm)	Heat Sink Finish	Weight lbs. (grams)
606-77AB	1.185 (30.1) sq	.767 (19.5)	Black Anodized	.041 (18.7)

Material: Aluminum, Black Anodized

### MECHANICAL DIMENSIONS

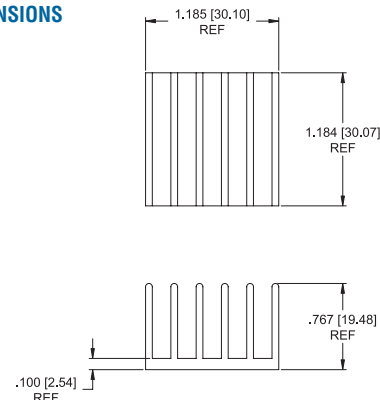

### 606 THERMAL PERFORMANCE

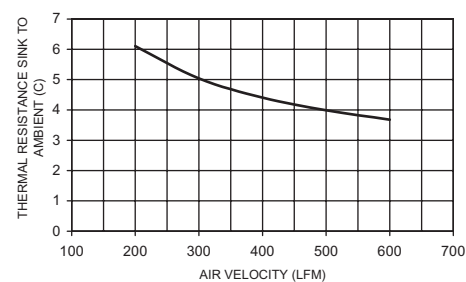

## HEAT SINKS FOR BGAs, SUPER BGAs, PBGAs, and FPBGAs



**607 SERIES** Unidirectional Fin Heat Sink for BGAs

Standard P/N	Base Dimensions in. (mm)	Height in. (mm)	Heat Sink Finish	Weight lbs. (grams)
607-65AB	1.200 (30.5) x 1.105 (28.1)	.650 (16.5)	Black Anodized	.041 (18.7)

Material: Aluminum, Black Anodized

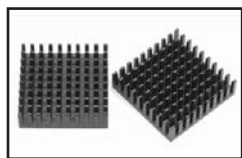
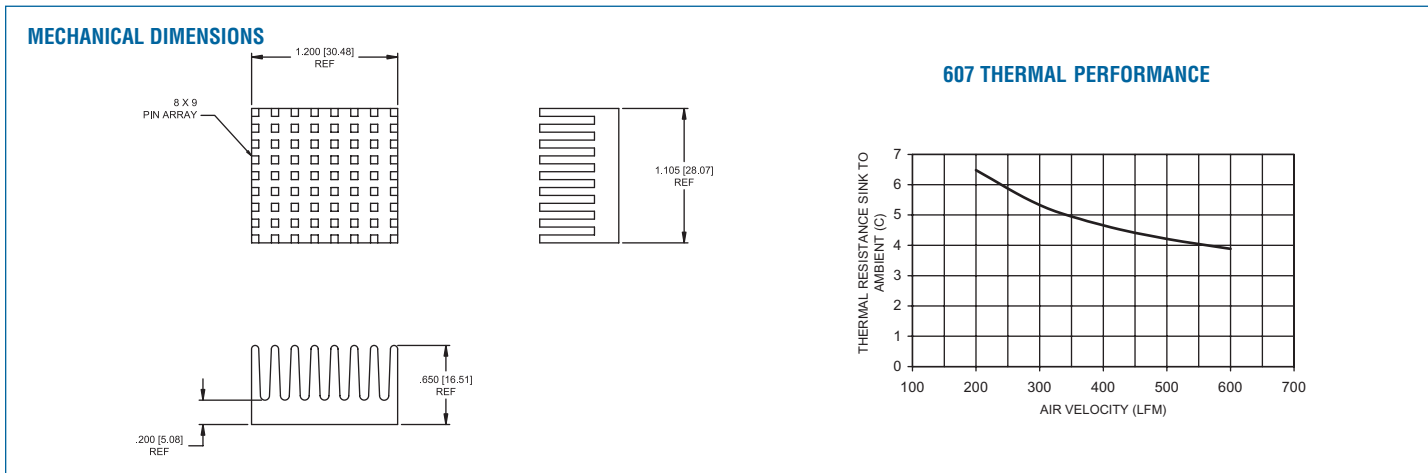

**610 SERIES** Omnidirectional Pin Fin Heat Sink for BGAs

Standard P/N	Base Dimensions in. (mm)	Height in. (mm)	Heat Sink Finish	Weight lbs. (grams)
610-35AB	1.240 (31.5) sq	.350 (8.9)	Black Anodized	.022 (10.0)
610-40AB	1.240 (31.5) sq	.400 (10.2)	Black Anodized	.024 (10.8)

Material: Aluminum, Black Anodized

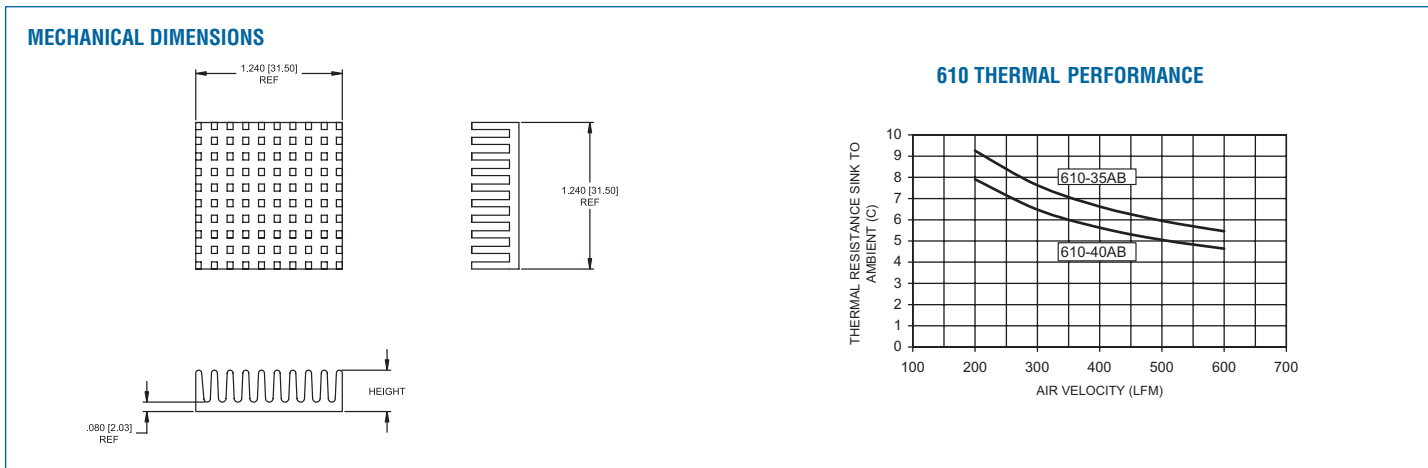

## HEAT SINKS FOR BGAs, SUPER BGAs, PBGAs, and FPBGAs

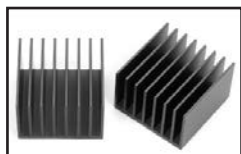

**611 SERIES** Unidirectional Fin Heat Sink for BGAs

Standard P/N	Base Dimensions in. (mm)	Height in. (mm)	Heat Sink Finish	Weight lbs. (grams)
611-80AB	1.200 (30.5) sq	.800 (20.3)	Black Anodized	.036 (16.3)

Material: Aluminum, Black Anodized

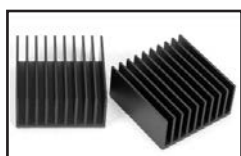
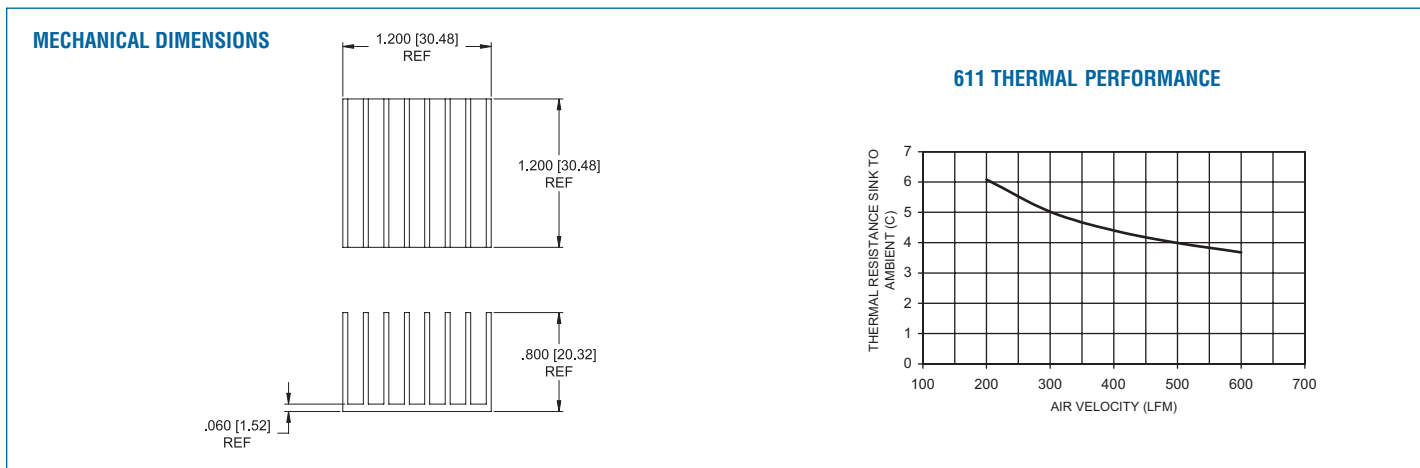

**612 SERIES** Unidirectional Fin Heat Sink for BGAs

Standard P/N	Base Dimensions in. (mm)	Height in. (mm)	Heat Sink Finish	Weight lbs. (grams)
612-65AB	1.390 (35.3) sq	.650 (16.5)	Black Anodized	.054 (24.5)

Material: Aluminum, Black Anodized

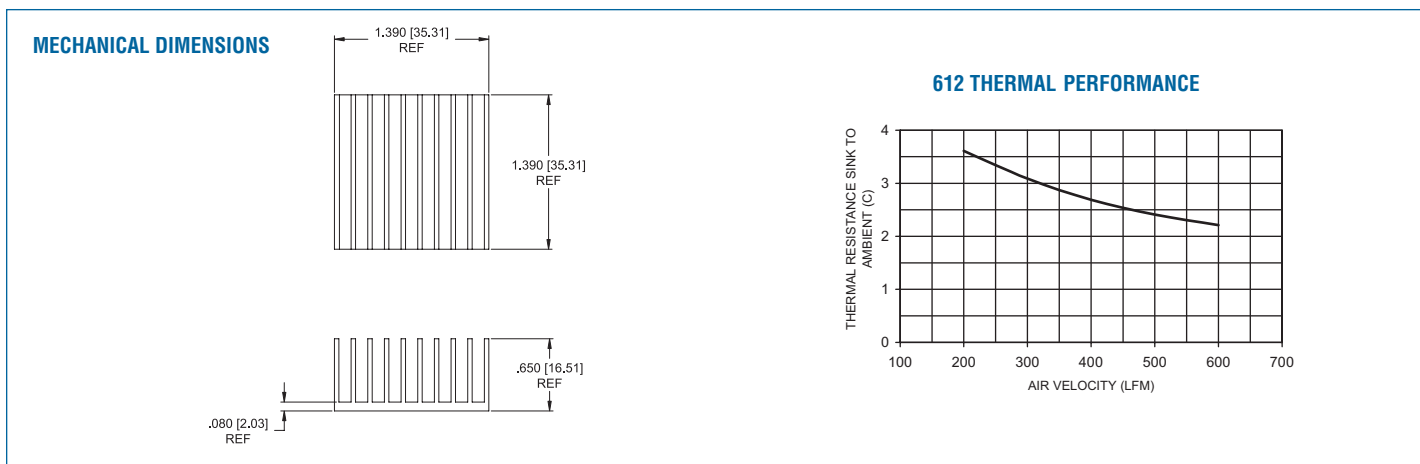



## HEAT SINKS FOR BGAs, SUPER BGAs, PBGAs, and FPBGAs

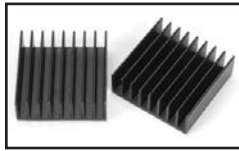

**613 SERIES** Unidirectional Fin Heat Sink for BGAs

Standard P/N	Base Dimensions in. (mm)	Height in. (mm)	Heat Sink Finish	Weight lbs. (grams)
613-50AB	1.450 (36.8) sq	.500 (12.7)	Black Anodized	.046 (20.8)

Material: Aluminum, Black Anodized

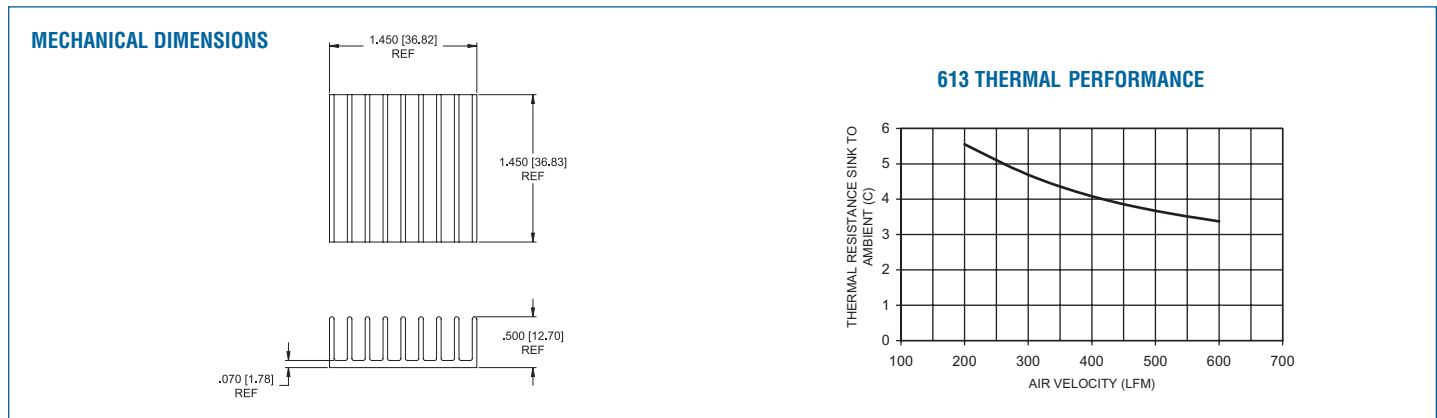

**614 SERIES** Unidirectional Fin Heat Sink for BGAs

Standard P/N	Base Dimensions in. (mm)	Height in. (mm)	Heat Sink Finish	Weight lbs. (grams)
614-30AB	1.500 (38.1) sq	.300 (7.6)	Black Anodized	.030 (13.8)
614-50AB	1.500 (38.1) sq	.500 (12.7)	Black Anodized	.048 (21.8)
614-100AP	1.500 (38.1) sq	1.000 (25.4)	Plain	.046 (20.9)

Material: Aluminum, Black Anodized or Plain

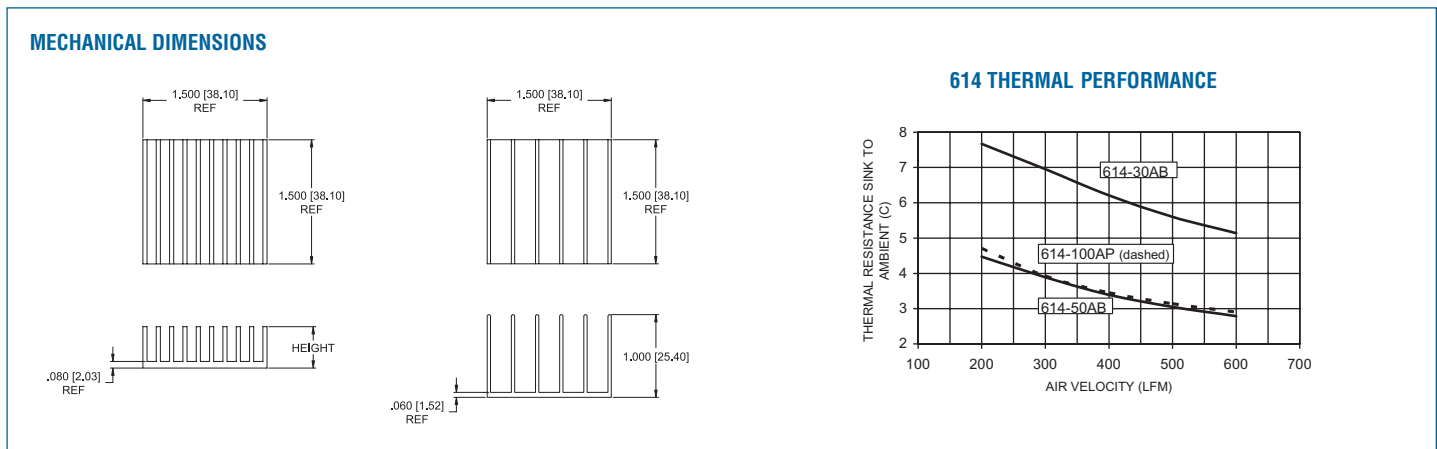

## HEAT SINKS FOR BGAs, SUPER BGAs, PBGAs, and FPBGAs

**615 SERIES** *Unidirectional Fin Heat Sink for BGAs*

Standard P/N	Base Dimensions in. (mm)	Height in. (mm)	Heat Sink Finish	Weight lbs. (grams)
615-41AB	1.600 (40.6) sq	.410 (10.4)	Black Anodized	.046 (21.0)

Material: Aluminum, Black Anodized

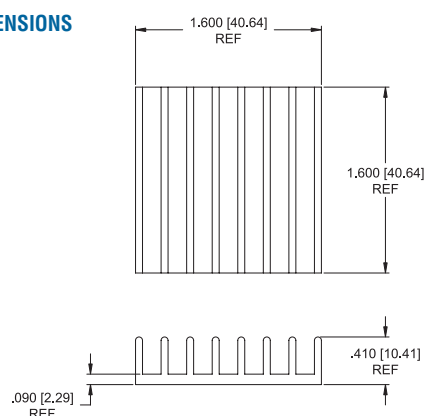
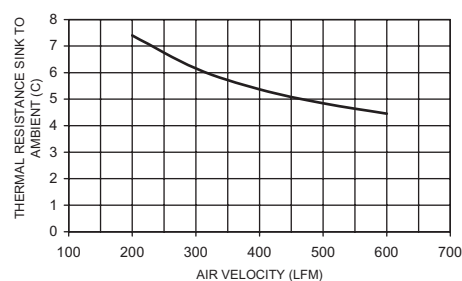
**MECHANICAL DIMENSIONS**

**615 THERMAL PERFORMANCE**

**616 SERIES** *Unidirectional Fin Heat Sink for BGAs*

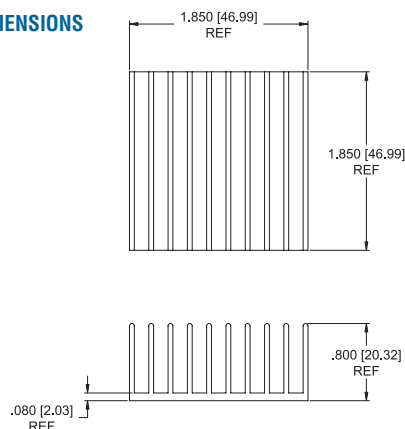
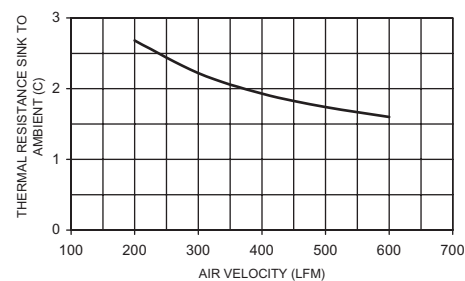
Standard P/N	Base Dimensions in. (mm)	Height in. (mm)	Heat Sink Finish	Weight lbs. (grams)
616-80AB	1.85 (47.0) sq	.800 (20.3)	Black Anodized	.054 (24.5)

Material: Aluminum, Black Anodized

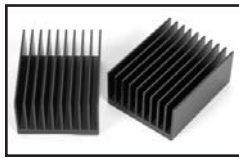
**MECHANICAL DIMENSIONS**

**616 THERMAL PERFORMANCE**

## HEAT SINKS FOR BGAs, SUPER BGAs, PBGAs, and FPBGAs



**617 SERIES** *Unidirectional Fin Heat Sink for BGAs*

Standard P/N	Base Dimensions in. (mm)	Height in. (mm)	Heat Sink Finish	Weight lbs. (grams)
617-80AB	1.450 (36.8) x 1.850 (47.0)	.800 (20.3)	Black Anodized	.082 (37.2)

Material: Aluminum, Black Anodized

### MECHANICAL DIMENSIONS

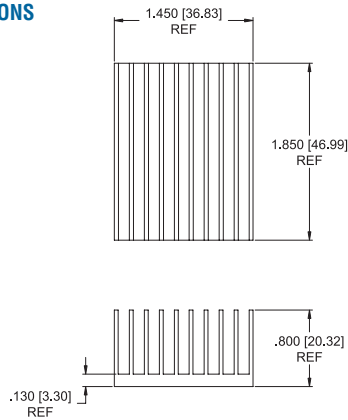

### 617 THERMAL PERFORMANCE

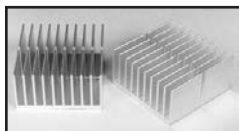
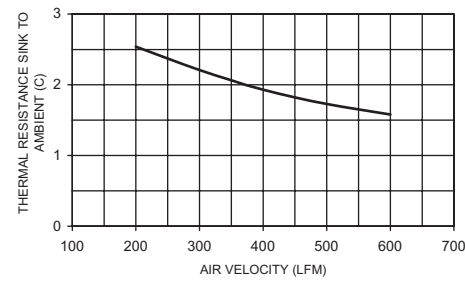

**618 SERIES** *Unidirectional Fin Heat Sink for BGAs*

Standard P/N	Base Dimensions in. (mm)	Height in. (mm)	Heat Sink Finish	Weight lbs. (grams)
618-20AB	2.00 (50.8) sq	.200 (5.1)	Black Anodized	.046 (21.0)
618-100AP	2.00 (80.8) sq	1.000 (25.4)	Plain	.122 (55.5)

Material: Aluminum, Black Anodized or Plain

### MECHANICAL DIMENSIONS

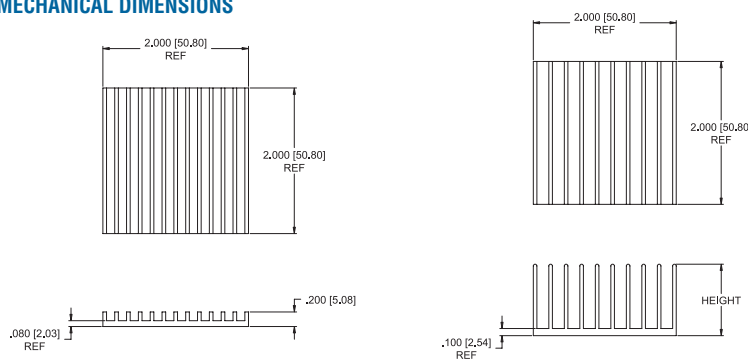

### 618 THERMAL PERFORMANCE

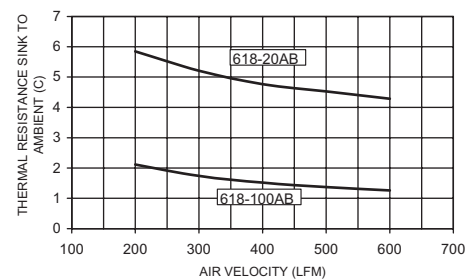

## HEAT SINKS FOR BGAs, SUPER BGAs, PBGAs, and FPBGAs

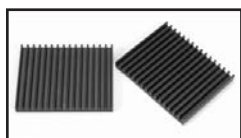
**620 SERIES** *Unidirectional Fin Heat Sink for BGAs*

Standard P/N	Base Dimensions in. (mm)	Height in. (mm)	Heat Sink Finish	Weight lbs. (grams)
620-24AB	2.500 (63.5) x 2.000 (50.8)	.235 (6.0)	Black Anodized	.063 (28.6)

Material: Aluminum, Black Anodized

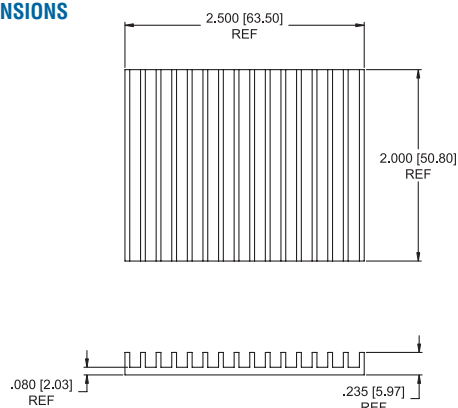
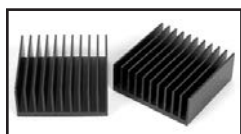
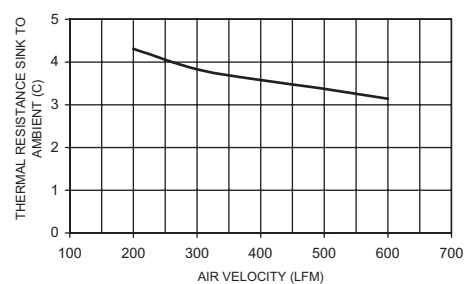
**MECHANICAL DIMENSIONS**

**620 THERMAL PERFORMANCE**

**622 SERIES** *Unidirectional Fin Heat Sink for BGAs*

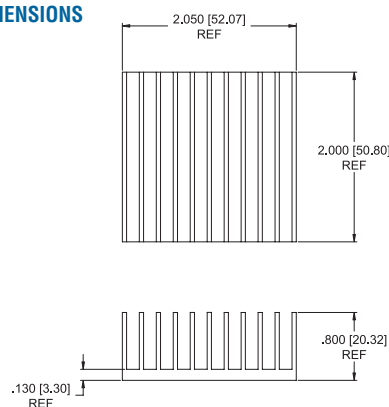
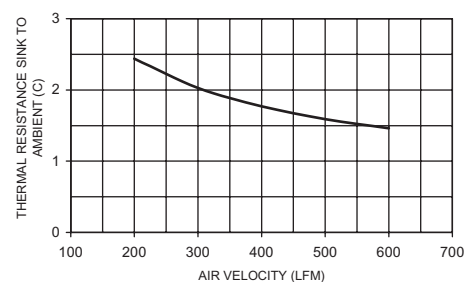
Standard P/N	Base Dimensions in. (mm)	Height in. (mm)	Heat Sink Finish	Weight lbs. (grams)
622-80AB	2.050 (52.1) x 2.000 (50.8)	.800 (20.3)	Black Anodized	.123 (56.0)

Material: Aluminum, Black Anodized

**MECHANICAL DIMENSIONS**

**622 THERMAL PERFORMANCE**

## HEAT SINKS FOR MICROPROCESSORS AND ASICs

**569, 579, 589, 599 SERIES** Heat Sinks & Clip for Intel's Pentium, Pentium MMX, AMD's K6 & K62, CYRIX's 6x86 & Media GX, Centaur/IDT's WinChip C6

Standard P/N	Base Dimensions in. (mm)	Fin Height in. (mm)	Thermal Resistance at 200 LFM (°C/W)	Interface Material Options
569-100AK	2.34 (59.44) x 2.68 (67.95)	1.00 (25.4)	1.7	Pages 74-76
579-150AK	2.15 (54.71) x 1.95 (49.53)	1.50 (38.10)	1.6	Pages 74-76
589-150AK	2.15 (54.71) x 3.10 (78.74)	1.50 (38.10)	1.5	Pages 74-76
599X-100AB	1.96 (49.78) x 2.67 (67.95)	1.00 (25.4)	1.9	Pages 74-76

Material: Aluminum, Black Anodized

### PRODUCT FEATURES

- Compact design heat sinks can comfortably fit a variety of Robust Socket 7-based PC boxes
- Robust clip attachments
- Clips are not captive to sink
- To order heat sink with optional interface material pre-applied at the factory, add S4 or S5 suffix to the part number. (See Product Designation)

**569-100AK SERIES**

### MECHANICAL DIMENSIONS

OPTIONAL THERMAL INTERFACE PAD (SEE PRODUCT DES.)

SPRING CLIP OPTION (SEE PRODUCT DES.)

### PRODUCT DESIGNATION

**569 - 100 XX - XX**

MODEL NUMBER	569	100	XX	XX
HEIGHT	100 = 1.00"			
THERMAL INTERFACE	S4 = DELTALINK IV	BLANK = NO THERMAL PAD		
CLIP	AK = SPRING CLIP			

Dimensions: in.

### 650/651 SERIES

**Low-Cost Heat Sinks for DIPs and SRAMs**

14-16 Pin DIPs

Standard P/N	Length in. (mm)	Width in. (mm)	Height in. (mm)	Typical Applications	Weight lbs. (grams)
650B	0.250 (6.4)	0.740 (18.9)	0.240 (6.1)	14-Pin, 16-Pin DIP	0.003 (1.36)
651B	0.750 (19.1)	0.415 (10.5)	0.240 (6.1)	14-Pin, 16-Pin DIP	0.005 (2.27)

These extruded heat sinks serve as low-cost heat dissipation solutions for DIPs with pin counts from 14 to 16. Use an epoxy such as Wakefield Engineering DeltaBond™ 152 or 155, or use Wakefield 2-part DeltaBond™ 156 modified acrylic adhesive. The 650 and 651 are also available in natural aluminum finish. They can be ordered as 650P or 651P.

### MECHANICAL DIMENSIONS

Notes:  
1. Finish: black anodize  
2. TIR: Total Indicator Reading. This is a measure of flatness across the greatest dimension of a surface.

Dimensions: in. (mm)

### NATURAL AND FORCED CONVECTION CHARACTERISTICS

HEAT SINKS FOR MICROPROCESSORS AND ASICs

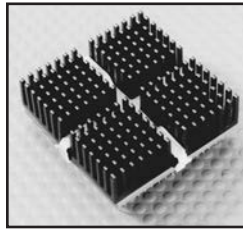

**649 SERIES** SpiderClip™ Heat Sink Assembly for Motorola MC68040™, MC68060

18 x 18 PGA

Standard P/N	Base Dimensions in. (mm)	Height in. (mm)	Base Thickness in. (mm)	Clip Color	Heat Sink Finish	Weight lbs. (grams)
649-33AB	1.70 (43.2) sq	0.315 (8.0)	0.090 (2.3)	Gray	Black Anodized	0.044 (19.84)
649-51AB	1.86 (47.2) sq	0.510 (13.0)	0.090 (2.3)	Gray	Black Anodized	0.056 (25.51)

MECHANICAL DIMENSIONS

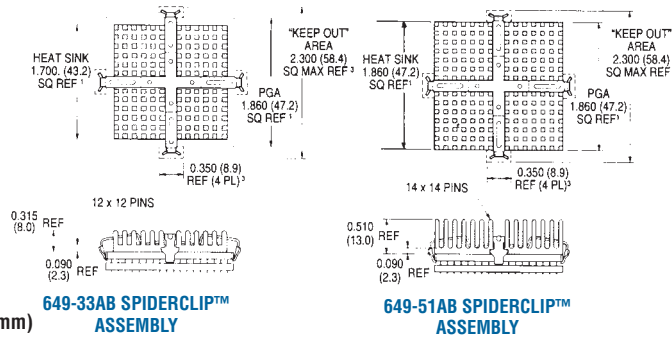

NATURAL AND FORCED CONVECTION CHARACTERISTICS

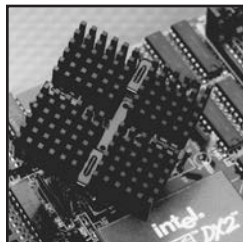
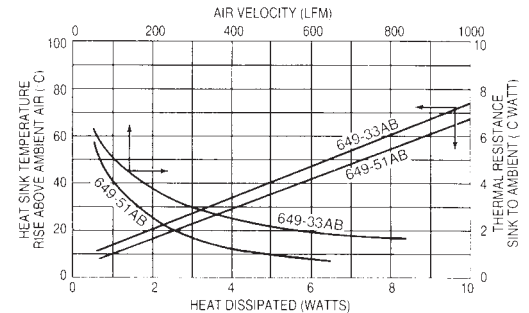

**669 SERIES** SpiderClip™ Heat Sink Assembly for Intel®DX4™, AMD AM486DX2, and AM486DX4

17 x 17 SPGA

**661 SERIES** Heat Sink without clip

Standard P/N	Base Dimensions in. (mm)	Dimensions "A" Height in. (mm)	Base Thickness in. (mm)	Clip Color	Standard Finish	Weight lbs. (grams)
669-32AG	1.70 (43.2) sq	0.315 (8.0)	0.090 (2.3)	Black	Gold Iridite	0.044 (19.84)
669-33AB	1.70 (43.2) sq	0.315 (8.0)	0.090 (2.3)	Black	Black Anodized	0.044 (19.84)
669-40AB	1.70 (43.2) sq	0.400 (10.2)	0.090 (2.3)	Black	Black Anodized	0.044 (19.84)
669-52AB	1.70 (43.2) sq	0.520 (13.2)	0.090 (2.3)	Black	Black Anodized	0.050 (22.68)
661-32AG	1.70 (43.2) sq	0.315 (8.0)	0.090 (2.3)	N/A	Gold Iridite	0.044 (19.84)
661-33AB	1.70 (43.2) sq	0.315 (8.0)	0.090 (2.3)	N/A	Black Anodized	0.044 (19.84)
661-40AB	1.70 (43.2) sq	0.400 (10.2)	0.090 (2.3)	N/A	Black Anodized	0.044 (19.84)
661-52AB	1.70 (43.2) sq	0.520 (13.2)	0.090 (2.3)	N/A	Black Anodized	0.050 (22.68)

669 Series SpiderClip™ Heat Sink Assemblies may be applied to the following:

- Intel 80486DX and 80486DX2™ (168 PGA)
- Intel 82495 Cache Controller
- Intel DX4™ (168 PGA)
- AMD Am 29000 Microcontrollers
- Intel 80486SX (168 PGA) and I860XR (208 PGA)
- AMD Am 486 Microprocessors AM486DX2, AM486DX4
- Intel I960CA, I960CF Embedded Controllers

MECHANICAL DIMENSIONS

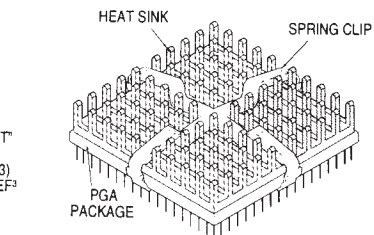
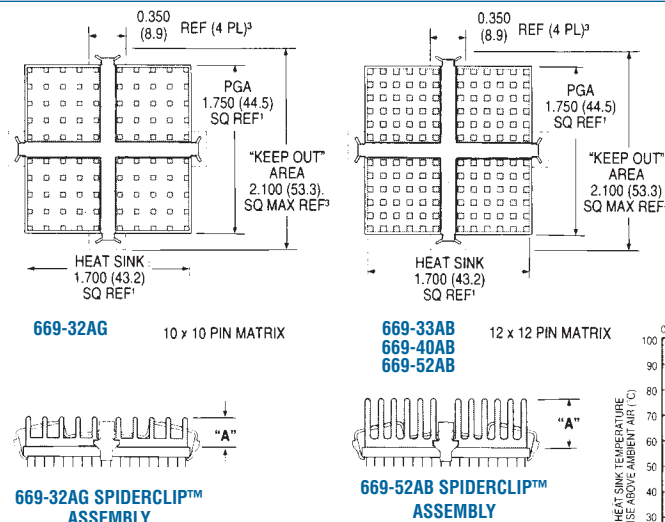

NATURAL AND FORCED CONVECTION CHARACTERISTICS

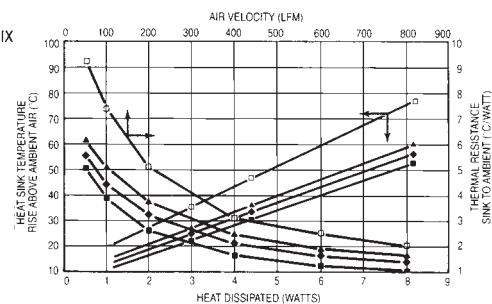

Dielectric Breakdown (Nylon Clip Coating)

Dimensions: in. (mm)  
Dielectric Strength: 100 VDC/mil  
Breakdown Voltage: 200 VDC (minimum)

- KEY:
- 669-32AG 0.315 (8.0) Pin Height, low density pin pattern
  - ▲ 669-33AB 0.315 (8.0) Pin Height, high density pin pattern
  - ◆ 669-40AB 0.400 (10.2) Pin Height, high density pin pattern
  - 669-52AB 0.520 (13.2) Pin Height, high density pin pattern



# Mouser Electronics

Authorized Distributor

Click to View Pricing, Inventory, Delivery & Lifecycle Information:

## Wakefield-Vette:

[628-40AB](#) [614-30ABT5](#) [658-60ABT1](#) [658-60ABT4](#) [658-60ABT3](#) [658-60ABT2](#) [655-53AB](#) [658-25ABT2](#) [658-25ABT1](#) [658-25ABT4](#) [D10850-40](#) [658-45ABT2](#) [658-45ABT4](#) [658-45ABT3](#) [D10650-40](#) [628-65AB](#) [625-25ABT4](#) [624-25ABT4](#) [609-50ABS3](#) [658-35ABT3](#) [658-35ABT4](#) [D10850-40T2](#) [658-45ABT5](#) [630-45ABT1](#) [630-45ABT1E](#) [662-15AG](#) [624-25ABT4E](#) [D10650-40T1](#) [D10650-40T5](#) [D10850-40T3](#) [D10850-40T5](#) [624-35ABT4](#) [625-35AB](#) [625-45AB](#) [625-45ABT3](#) [625-60AB](#) [628-25AB](#) [628-35ABT1](#) [628-65ABT4](#) [630-25ABT5](#) [630-45AB](#) [630-45ABT3](#) [642-25ABT3](#) [642-35AB](#) [642-45ABT3](#) [655-53ABT1](#) [655-53ABT3](#) [658-25ABT3](#) [658-25ABT5](#) [658-35ABT5](#) [658-60ABT5](#) [660-29AB](#) [660-29ABT5](#) [625-35ABT5](#) [628-65ABT4E](#) [655-53ABT1E](#) [662-15ABT3](#) [D10650-40T1E](#) [D10650-40T4E](#) [D10850-40T4E](#) [655-53ABT5](#) [642-25AB](#) [625-35ABTIE](#) [62460ABT3](#) [624-60AB-T4](#) [610-40AB](#) [642-45AB](#) [604-60ABT5](#) [630-35AB](#) [659-65AB](#) [655-26AB](#) [628-20AB](#) [630-25AB](#) [625-25ABT5](#) [625-25AB](#) [D10650-40T3](#) [609-50AB](#) [609-100AB](#) [630-60AB](#) [698-65AB](#) [698-100AB](#) [642-60AB](#) [628-40ABT3](#) [624-60ABT3](#) [625-35ABT1E](#) [669-52ABT3](#) [D10850-40 \(BULK\)](#) [604-60AB](#) [625-25ABT4E](#) [625-45ABT4E](#) [625-45ABT5](#)