

Data Sheet

Handheld Digital Storage Oscilloscopes 2510 Series



The 2510 Series handheld digital storage oscilloscopes provide floating measurement and recorder capabilities with a built-in digital multimeter (DMM), all in one portable and lightweight package. These versatile 60 MHz and 100 MHz bandwidth scopes offer 1 GSa/s sample rates, 2 Mpts waveform memory, 32 automatic measurements, and multiple recording functions to capture transient or long-term signal behavior.

The built-in 6000-count multimeter allows users to quickly switch over from an oscilloscope to a DMM to measure DC/AC voltage and current, resistance, and capacitance, including diode and continuity tests.

These handheld scopes feature many useful recording functions such as trend plot, which allows data logging from the scope or multimeter. Additionally, the scope recorder function offers users 7 Mpts record length on a single channel or 3.5 Mpts on dual channel.

The 2510 Series handheld oscilloscopes are ideal for industrial applications, power systems, electronics design, and field test and service.

Features and Benefits

- 60 MHz (2511/2515) and 100 MHz (2512/2516) bandwidth
- 1 GSa/s sample rate
- Deep waveform memory up to 2 Mpts
- 2 fully isolated and floating 1,000 V CAT II, 600 V CAT III rated inputs (isolated models 2515 and 2516)
- 300 V CAT II rated inputs (non-isolated models 2511 and 2512)
- Built-in 6000-count DMM with dedicated terminals for current measurement
- Scope and meter trend plot functions for data logging
- Bright 5.7" color display
- Compact and lightweight – 3.4 lbs (1.54 kg)
- FFT including four additional math functions - Add, Subtract, Multiply, and Divide
- 32 automatic measurements
- USB host port for saving and recalling waveform setups, data, and screenshots on a USB flash drive
- Software provided for remote PC control
- Advanced tools include digital filters with adjustable limits, scope and waveform recorder mode
- Multi-language user interface
- Up to four hours of continuous battery operation

Model	2511	2512	2515	2516
Bandwidth	60 MHz	100 MHz	60 MHz	100 MHz
Channels	2 non-isolated		2 fully isolated	
Typical Applications	General electronics		Power electronics and industrial	

Front Panel



The tools you need

2 Mpts Deep Memory

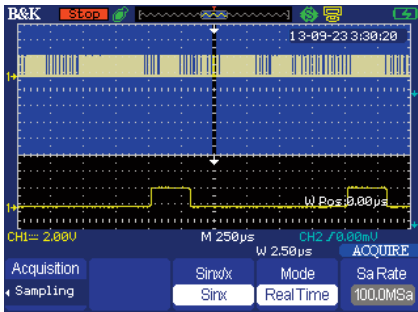

See more details in your waveform with deep memory. When enabled, waveforms can be captured in high resolution while maintaining a high sample rate over a wider period of time than other comparable scopes.

Powerful Measurement Functions

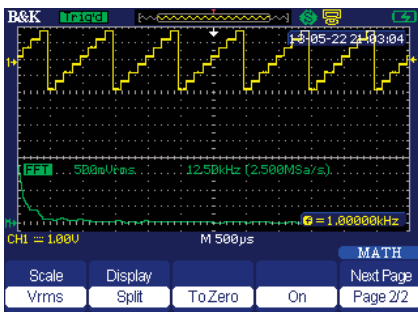

Display and measure the input signal's frequency spectrum. Select one of the 4 FFT windows: Rectangular, Hanning, Hamming, and Blackman. Use cursors to measure the spectral component's magnitude and frequency.

Digital Filtering

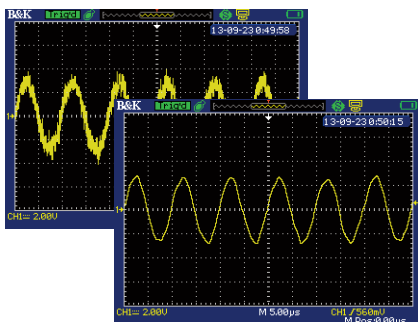

Filter out unwanted signal components such as various types of noise with built-in digital filters. Choose from Low-Pass, High-Pass, Band-Pass, and Band-Stop filters.

Built-in Digital Multimeter

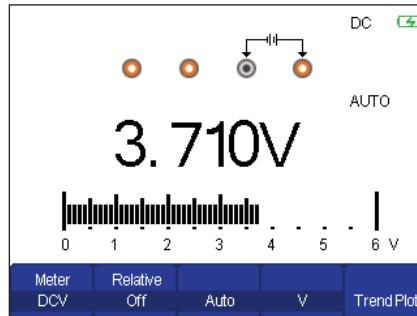

Speed up troubleshooting with the built-in 6000-count multimeter. Measurement functions include AC/DC voltage and current, resistance, capacitance, diode, and continuity test.

Scope and Waveform Recorder Modes

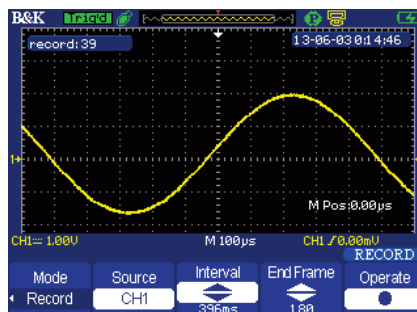

Monitor and analyze long-term signal behavior by recording data continuously over a period of time. These modes allow recorded data to be played back for post acquisition analysis.

Portable Operation



Quickly troubleshoot in the field using battery powered operation. Built for portability, the 2510 Series handheld digital oscilloscopes are rugged, compact, and lightweight. All models come standard with travel case for safe transport on the road.

Scope and Meter Trend Plot Functions

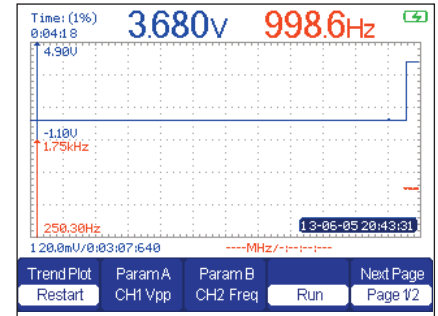

Scope Trend Plot

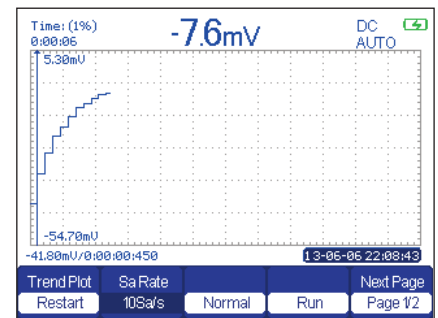

Meter Trend Plot

Capture intermittent errors in your system. The trend plot function can be used with the oscilloscope or built-in DMM to plot measurement values over time. Up to two voltage or time parameters can be selected by the scope, and any one of the multimeter's measurement functions can be graphed. These data points can then be exported to a CSV file for further analysis.

PC Connectivity

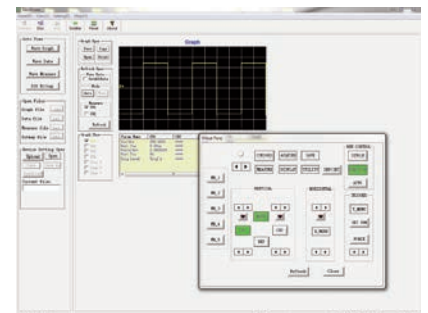

PC software provided (free download from www.bkprecision.com) for seamless integration between the oscilloscope and PC. Capture and transfer waveforms, screen images, setups and measurement results to a Windows PC via the USB device port on the side of the instrument. A USB host port is also available for quick and easy screen saving.

Floating and Differential Measurements

Many industrial applications such as power electronics require measurements of high voltages and currents that are not referenced to ground. This poses an issue with traditional line-powered oscilloscopes, which typically have signal common connected to the chassis of the oscilloscope. This means all measurements must be made relative to earth ground, preventing users from making differential measurements where none of the test points are referenced to ground.

As a workaround, some people choose to float an oscilloscope by removing the connection between the instrument's chassis and power line ground. Floating a scope is not recommended as it can put the user at a safety risk. Parasitic capacitance is also induced in the measurement which can cause ringing and invalidate the measurement. The 2510 Series allows engineers and technicians to make accurate and safe measurements when the signal reference is floating.

Fully Isolated Channel Design for Safe Measurements (models 2515/2516 only)

Models 2515 and 2516 offer two CAT III 600 V input channels for floating measurements and feature an electrically isolated circuit design

between inputs and the digital acquisition circuit. Isolating the ground references eliminate ground loops and help reduce channel noise and crosstalk.

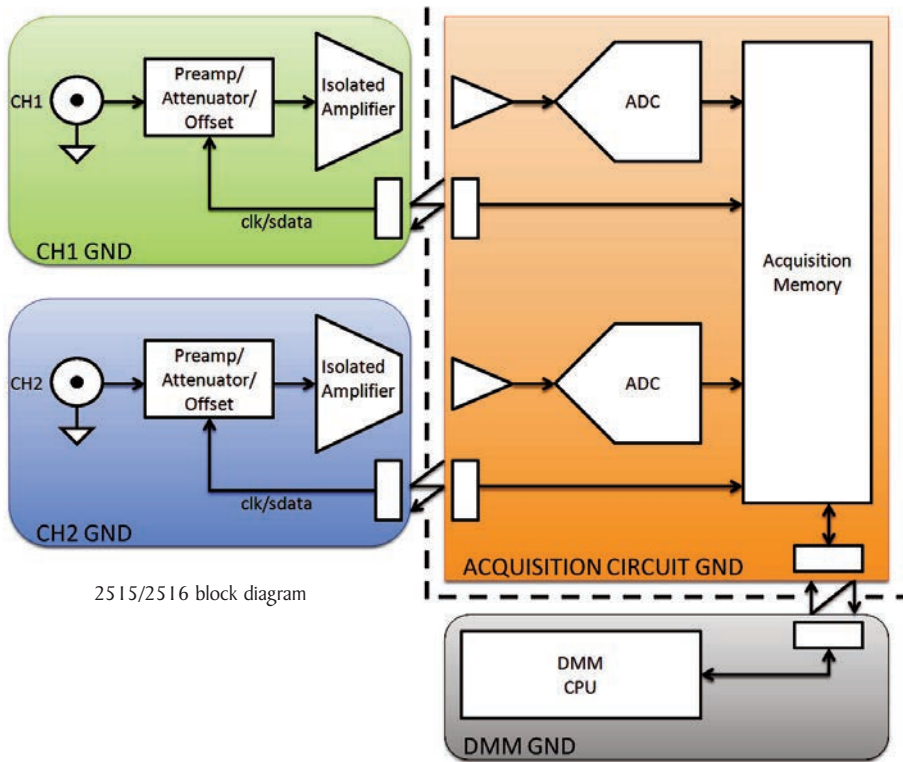

2515/2516 block diagram

Safety Rated High Bandwidth Oscilloscope Probes



Probe Model PR250SA



Probe Model PRI50SA

All 2510 Series models come standard with high bandwidth, safety certified passive probes (one per channel) to help you get the most out of your scope.

Model	Included Probes
2511	Two 150 MHz bandwidth, x1/x10 probes rated for 300 V CATII measurements
2512	
2515	Two touch-protected 250 MHz bandwidth, x10 probes rated for 1000 V CATII, 600 V CATIII measurements
2516	

Input Signal and Float Voltage Safety Ratings

Model	2511 / 2512	2515 / 2516
Maximum signal input safety rating with included probe	300 Vrms CAT II	1000 Vrms CAT II, 600 Vrms CAT III
Maximum signal input safety rating without probe	300 Vrms CAT II	300 Vrms CAT II
Maximum reference floating safety rating	30 Vrms	1000 Vrms CAT II, 600 Vrms CAT III

Digital Storage Oscilloscope Specifications

Models	2511	2512	2515	2516
Performance Characteristics				
Bandwidth	60 MHz	100 MHz	60 MHz	100 MHz
Real Time Sampling Rate	1 GSa/s (half-channel interleaved) ⁽¹⁾ , 500 MSa/s (per channel)			
Channels	2 non-isolated		2 isolated	
Rise Time	< 5.8 ns	< 3.5 ns	< 5.8 ns	< 3.5 ns
Ch-to-Ch Isolation (both channels at same V/div setting)	> 100:1 at 50 MHz			
Memory Depth	40 kpts (half-channel interleaved) ⁽¹⁾⁽²⁾ , 20 kpts (per channel)			
Deep Memory ⁽³⁾	2 Mpts (half-channel interleaved) ⁽¹⁾ , 1 Mpts (per channel)			
Vertical Resolution	8 bits			
Vertical Sensitivity	2 mV/div – 100 V/div (1-2-5 order)		5 mV/div – 100 V/div (1-2-5 order)	
DC Gain Accuracy	5 mV/div-100 V/div: $\leq \pm 4\%$			
Max. BNC Input Voltage	CATII 300 Vrms from BNC signal to BNC shell			
Max. Input Voltage for Probe	PR150SA ⁽⁴⁾ : 1x/10x CAT II 300 V PR250SA ⁽⁵⁾⁽⁶⁾ : 10x CAT III 600 V, CATII 1000 V			
Channel Voltage Offset Range	2 mV - 200 mV : ± 1.6 V 206 mV - 10 V : ± 40 V 10.2 V - 100 V : ± 400 V		5 mV - 200 mV : ± 1.6 V 206 mV - 10 V : ± 40 V 10.2 V - 100 V : ± 400 V	
Bandwidth Limit	20 MHz (-3 dB)			
Horizontal Scan Range	5.0 nS/div - 50 S/div	2.5 nS/div - 50 S/div	5.0 nS/div - 50 S/div	2.5 nS/div - 50 S/div
Timebase Accuracy	± 50 ppm measured over 1 ms interval			
Input Coupling	AC, DC, GND			
Input Impedance	1 M Ω +/- 2% 18 pF ± 3 pF		1 M Ω +/- 2% 16 pF ± 3 pF	
Probe Attenuation Selectable Factors	1X, 5X, 10X, 50X, 100X, 500X, 1000X			
Vertical and Horizontal Zoom	Vertically or horizontally expand or compress a live or stopped waveform			
I/O Interface				
USB	USB host port support USB flash drives (FAT format) mini-USB device port for PC connectivity and probe compensation			
Acquisition Modes				
Sampling	Display sample data only			
Peak Detect	Capture the maximum and minimum values of a signal			
Average	Waveform averaged, selectable from 4, 16, 32, 64, 128, 256			
Trigger System				
Trigger Types	Edge, Pulse Width, Video*, Slope, Alternative *Support signal formats: PAL/SECAM, NTSC Trigger condition: odd field, even field, all lines, or line number			
Trigger Modes	Auto, Normal, Single			
Trigger Coupling	AC, DC, LF reject, HF reject			
Trigger Source	CH1, CH2			
Trigger Level Range	± 6 divisions from center of display			
Trigger Displacement	Pre-trigger: Memory depth / 2* sampling Delay Trigger: 268.04 div			
Pulse Width Trigger	Positive slope (>, <, =), Negative slope (>, <, =), Time: 20 ns - 10 s			
Slope Trigger	Positive slope (>, <, =), Negative slope (>, <, =), Time: 20 ns - 10 s			
Alternate Trigger	CH1 trigger type: Edge, Pulse, Video, Slope CH2 trigger type: Edge, Pulse, Video, Slope			

Digital Storage Oscilloscope Specifications (cont.)

Model	2511	2512	2515	2516
Hardware Frequency Counter				
Reading Resolution	1 Hz			
Range	DC couple, 10 Hz to MAX bandwidth			
Signal Types	Satisfying all trigger signals (except pulse width trigger and video trigger)			
Waveform Math and Measure				
Math Operation	Add, Subtract, Multiply, Divide, FFT			
FFT	Window mode: Hanning, Hamming, Blackman, Rectangular Sampling points: 1024			
Measure	Vpp, Vmax, Vmin, Vamp, Vtop, Vbase, Vavg, Mean, Crms, Vrms, ROVShoot, FOVShoot, RPREShoot, FPREShoot, Rise, Fall, Freq, Prd, +Wid, -Wid, +Dut, -Dut, BWid, Phas, FRR, FRE, FFR, FFF, LRR, LRF, LFR, LFF			
Cursors				
Types	Voltage, Time			
Measurements	ΔV , ΔT , $I/\Delta T$ (frequency)			
Display System				
Display	5.7" Color TFT, 320 x 234 resolution, 64K color			
Display Contrast (Typical)	150:1			
Backlight Intensity (Typical)	300 nits			
Wave Display Range	8 x 12 div			
Wave Display Mode	Dots, Vector			
Persistence	Off, 1 sec, 2 sec, 5 sec, Infinite			
Menu Display	2 sec, 5 sec, 10 sec, 20 sec, Infinite			
Screen-Saver	Off, 1 min., 2 min., 5 min., 10 min., 15 min., 30 min., 1 hr, 2 hr, 5 hr			
Waveform Interpolation	Sin(x)/x, Linear			
Measure Display Modes	Main, Window zoom, Scan, X-Y			
X-Y Sampling Frequency	Support 25 kSa/s - 250 MSa/s sampling rate (1-2.5-5 order)			
Color Mode	Normal, Invert			
Environmental and Safety				
Temperature	Operating: 32 °F to 104 °F (0 °C to +40 °C) Not operating: -4 °F to 158 °F (-20 °C to +70 °C)			
Humidity	Operating: 85% RH, 104 °F (40 °C), 24 hours			
Altitude	Operating: 9,842.5 ft (3,000 m)			
Electromagnetic Compatibility	EMC Directive 2004/108/EC, EN61326:2006			
Safety	Low voltage directive 2006/95/EC, EN61010-1:2001			
General				
Storage Memory	2 reference waveforms, 20 setups, 10 waveforms			
AC Adapter Power Requirements	Input: 100-240 VAC, 50/60 Hz Output: 9V DC, 4 A			
Battery Rating	5000 mAh, 7.4 VDC			
Battery Charge Time	Approx. 4 hrs			
Battery Operating Time	Approx. 4 hrs			
Dimensions (W x H x D)	6.42" x 10.21" x 2.10" (163.2 x 259.5 x 53.3 mm)			
Weight	Approx. 3.4 lbs (1.54 kg) including battery			
Three-Year Warranty				

- (1) Half channel operation means that only Ch1 or Ch2 is active.
- (2) When sampling rate is 1 GSa/s. For sampling rate \leq 500 MSa/s, the maximum memory depth is 20 kpts.
- (3) When sampling rate is < 500 MSa/s and maximum data depth mode is enabled.
- (4) Probe included with models 2511 and 2512 only.
- (5) Probe included with models 2515 and 2516 only.
- (6) Refer to respective probe's manual for more information on the specification.

Multimeter and Recorder Specifications

- All specifications are based on operating at temperatures $23 \pm 5^\circ\text{C}$ and relative humidity $< 75\%$.
- Accuracy is based on \pm (% of reading + offset).

Multimeter		
Display Resolution	6000 counts	
Measurement Function	DC voltage, AC voltage, resistance, diode, continuity, capacitance, DC current, AC current	
Max. Input Voltage	AC: 750 V (30 Hz - 1 kHz) DC: 1000 V	
Max. Input Current ⁽¹⁾	AC: 10 A (30 Hz - 1 kHz) DC: 10 A	
Input Impedance	10 M Ω	
Max. Input Voltage Between Multimeter Input Reference and Ground	CAT II 600 V CAT III 300 V	
DC Voltage		
Range	Resolution	Accuracy
60.00 mV	10 μV	\pm (1 % + 15 digits)
600.0 mV	100 μV	\pm (1 % + 5 digits)
6.000 V	1 mV	
60.00 V	10 mV	
600.0 V	100 mV	
1000 V	1 V	
AC Voltage ⁽²⁾		
Range	Resolution	Accuracy
60.00 mV	10 μV	\pm (1 % + 15 digits)
600.0 mV	100 μV	\pm (1 % + 5 digits)
6.000 V	1 mV	
60.00 V	10 mV	
600.0 V	100 mV	
750 V	1 V	
DC and AC Current ⁽³⁾⁽⁴⁾		
Range	Resolution	Accuracy
60.00 mA	10 μA	\pm (1.5 % + 5 digits)
600.0 mA	100 μA	
6.000 A	1 mA	\pm (2.5 % + 5 digits)
10.00 A	10 mA	
Resistance		
Range	Resolution	Accuracy
600.0 Ω	0.1 Ω	\pm (1 % + 5 digits)
6.000 k Ω	1 Ω	
60.00 k Ω	10 Ω	
600.0 k Ω	100 Ω	
6.000 M Ω	1 k Ω	
60.00 M Ω	10 k Ω	\pm (3 % + 5 digits)

Multimeter (cont.)		
Capacitance		
Range	Resolution	Accuracy
40.00 nF	10 pF	\pm (3 % + 10 digits)
400.0 nF	100 pF	\pm (4 % + 5 digits)
4.000 μF	1 nF	
40.00 μF	10 nF	
400.0 μF	100 nF	
Diode and Continuity Measure		
Diode	0 – 2 V	
Continuity	$< 50 \Omega$ alarm	

- Current input terminals protected with internal 250 V rated fuse.
- For frequency range 30 Hz to 1 kHz.
- For 10 A terminal, > 6 A DC or AC rms for 10 seconds ON and 15 minutes OFF.
- For AC current ranges, frequency is verified for 30 Hz to 1 kHz.

Recorder	
Scope Trend Plot	
Display Mode	Full view, Normal
Record Length	800k points, > 24 hours
Number of Channels	2
Multimeter Trend Plot	
Display Mode	Full view, Normal
Record Length	1.2M dots, > 24 hours
Number of Channels	1
Scope Recorder	
Display Mode	Full view, Normal
Max. Record Length	Single Channel: 7 M pts Dual Channel: 3.5 M pts
Number of Channels	2
Maximum Record Size to External Storage	4 GB, 3000 hours

Included Accessories

User manual, passive probes (one per channel), pair of DMM test leads, 7.4 V Li-ion battery BP2510, USB cable, probe compensation connector, AC power adapter, travel case LC2510B and certificate of calibration

Mouser Electronics

Authorized Distributor

Click to View Pricing, Inventory, Delivery & Lifecycle Information:

[B&K Precision:](#)

[2516](#) [2511](#) [2515](#) [2512](#) [PR250SA](#)