

## Standard Recovery Diodes, (Stud Version), 400 A



DO-9 (DO-205AB)

### FEATURES

- Wide current range
- High voltage ratings up to 2400 V
- High surge current capabilities
- Stud cathode and stud anode version
- Standard JEDEC® types
- Compression bonded encapsulations
- Designed and qualified for industrial level
- Material categorization: for definitions of compliance please see [www.vishay.com/doc?99912](http://www.vishay.com/doc?99912)

**RoHS  
COMPLIANT**

### PRIMARY CHARACTERISTICS

$I_{F(AV)}$	400 A
Package	DO-9 (DO-205AB)
Circuit configuration	Single

### TYPICAL APPLICATIONS

- Converters
- Power supplies
- Machine tool controls
- High power drives
- Medium traction applications

### MAJOR RATINGS AND CHARACTERISTICS

PARAMETER	TEST CONDITIONS	VALUES	UNITS
$I_{F(AV)}$		480	A
	$T_C$	120	°C
$I_{F(RMS)}$		630	A
$I_{FSM}$	50 Hz	8250	
	60 Hz	8640	
$I^2t$	50 Hz	340	kA <sup>2</sup> s
	60 Hz	311	
$V_{RRM}$	Range	1600 to 2400	V
$T_J$		-40 to +190	°C

### ELECTRICAL SPECIFICATIONS

#### VOLTAGE RATINGS

TYPE NUMBER	VOLTAGE CODE	$V_{RRM}$ , MAXIMUM REPETITIVE PEAK REVERSE VOLTAGE V	$V_{RSM}$ , MAXIMUM NON-REPETITIVE PEAK REVERSE VOLTAGE V	$I_{RRM}$ MAXIMUM AT $T_J = T_J$ MAXIMUM mA
VS-SD400N/R	16	1600	1700	15
	20	2000	2100	
	24	2400	2500	



FORWARD CONDUCTION					
PARAMETER	SYMBOL	TEST CONDITIONS		VALUES	UNITS
Maximum average forward current at case temperature	$I_{F(AV)}$	180° conduction, half sine wave		400	A
				120	°C
				480	A
				100	°C
Maximum RMS forward current	$I_{F(RMS)}$	DC at 110 °C case temperature		630	A
Maximum peak, one-cycle forward, non-repetitive surge current	$I_{FSM}$	t = 10 ms	No voltage reapplied	8250	
		t = 8.3 ms	No voltage reapplied	8640	
		t = 10 ms	100 % $V_{RRM}$ reapplied	6940	
		t = 8.3 ms	100 % $V_{RRM}$ reapplied	7270	
Maximum $I^2t$ for fusing	$I^2t$	t = 10 ms	No voltage reapplied	340	kA <sup>2</sup> s
		t = 8.3 ms	No voltage reapplied	311	
		t = 10 ms	100 % $V_{RRM}$ reapplied	241	
		t = 8.3 ms	100 % $V_{RRM}$ reapplied	220	
Maximum $I^2\sqrt{t}$ for fusing	$I^2\sqrt{t}$	t = 0.1 to 10 ms, no voltage reapplied		3400	kA <sup>2</sup> √s
Low level value of threshold voltage	$V_{F(TO)1}$	$(16.7 \% \times \pi \times I_{F(AV)} < I < \pi \times I_{F(AV)})$ , $T_J = T_J$ maximum		0.80	V
High level value of threshold voltage	$V_{F(TO)2}$	$(I > \pi \times I_{F(AV)})$ , $T_J = T_J$ maximum		0.85	
Low level value of forward slope resistance	$r_{f1}$	$(16.7 \% \times \pi \times I_{F(AV)} < I < \pi \times I_{F(AV)})$ , $T_J = T_J$ maximum		0.55	mW
High level value of forward slope resistance	$r_{f2}$	$(I > \pi \times I_{F(AV)})$ , $T_J = T_J$ maximum		0.51	
Maximum forward voltage drop	$V_{FM}$	$I_{pk} = 1500$ A, $T_J = T_J$ maximum, $t_p = 10$ ms sinusoidal wave		1.62	V

THERMAL AND MECHANICAL SPECIFICATIONS					
PARAMETER	SYMBOL	TEST CONDITIONS		VALUES	UNITS
Maximum junction operating temperature range	$T_J$			-40 to +190	°C
Maximum storage temperature range	$T_{Stg}$			-55 to +200	
Maximum thermal resistance, junction to case	$R_{thJC}$	DC operation		0.11	K/W
Maximum thermal resistance, case to heatsink	$R_{thCS}$	Mounting surface, smooth, flat and greased		0.04	
Maximum allowed mounting torque ± 10 %		Not-lubricated threads		27	Nm
Approximate weight				250	g
Case style		See dimensions (link at the end of datasheet)		DO-9 (DO-205AB)	

$\Delta R_{thJC}$ CONDUCTION				
CONDUCTION ANGLE	SINUSOIDAL CONDUCTION	RECTANGULAR CONDUCTION	TEST CONDITIONS	UNITS
180°	0.020	0.013	$T_J = T_J$ maximum	K/W
120°	0.023	0.023		
90°	0.029	0.031		
60°	0.042	0.044		
30°	0.073	0.074		

**Note**

- The table above shows the increment of thermal resistance  $R_{thJC}$  when devices operate at different conduction angles than DC

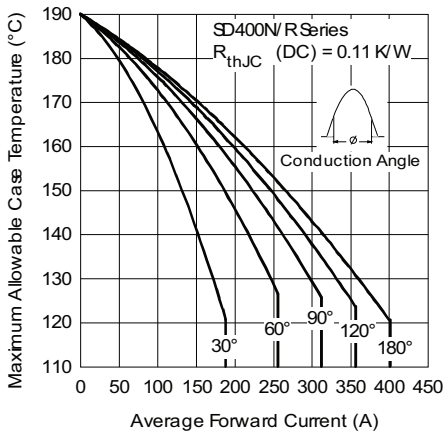

Fig. 1 - Current Ratings Characteristics

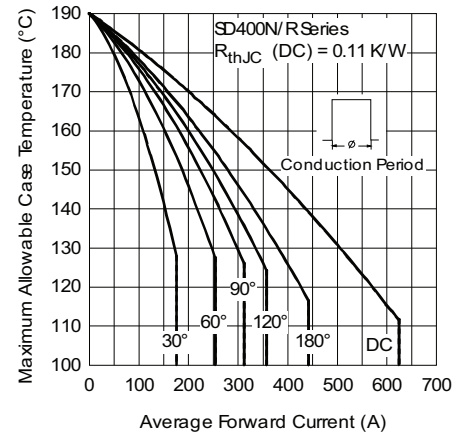

Fig. 2 - Current Ratings Characteristics

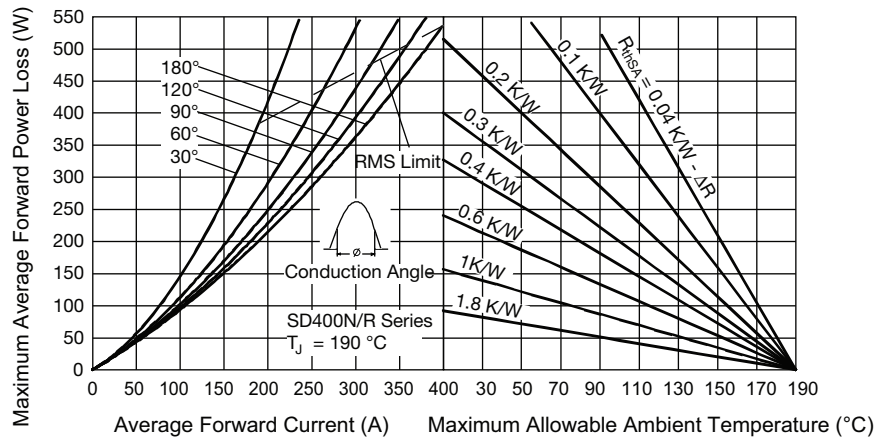

Fig. 3 - Forward Power Loss Characteristics

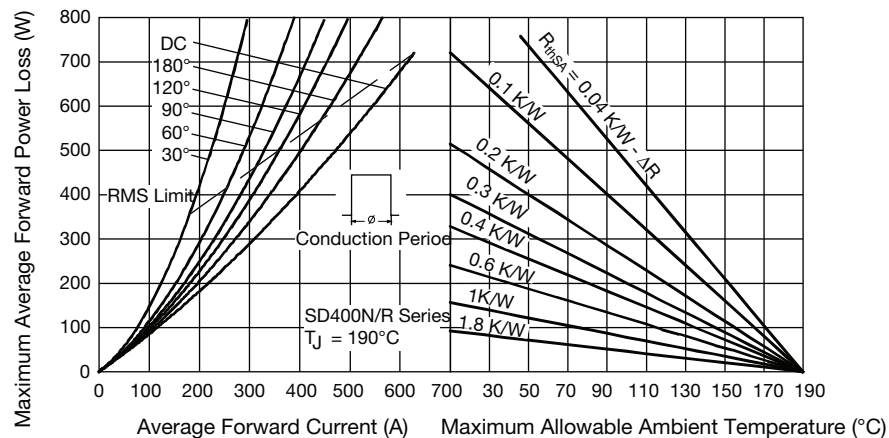

Fig. 4 - Forward Power Loss Characteristics

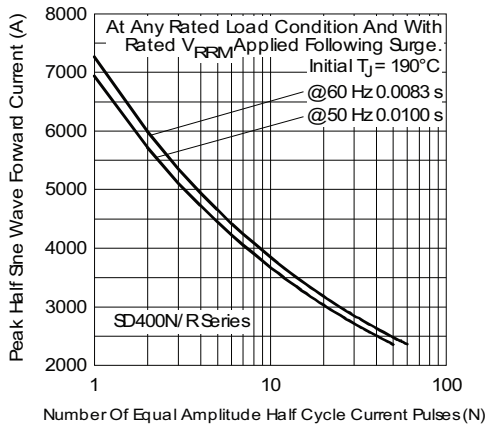

Fig. 5 - Maximum Non-Repetitive Surge Current

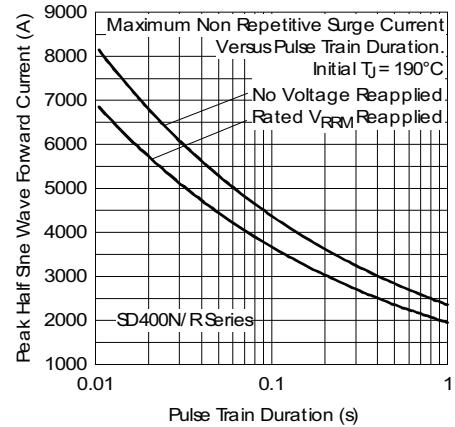

Fig. 6 - Maximum Non-Repetitive Surge Current

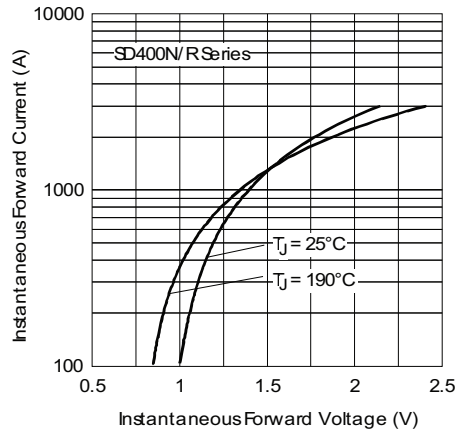

Fig. 7 - Forward Voltage Drop Characteristics

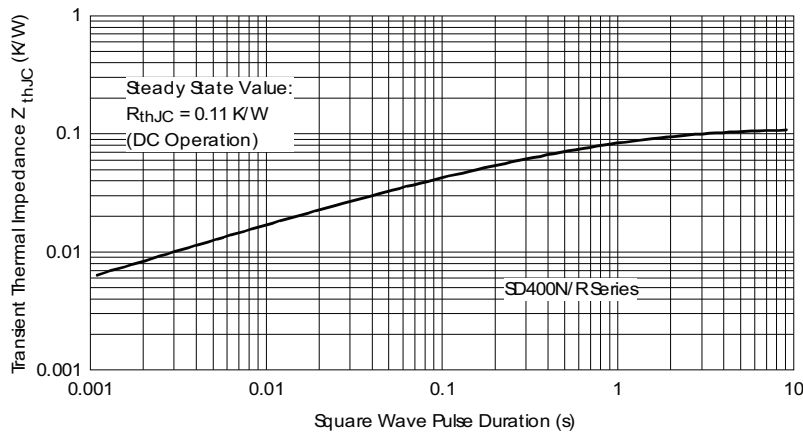
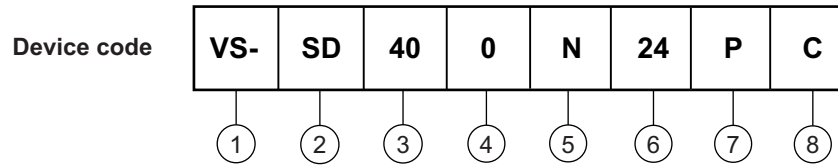

Fig. 8 - Thermal Impedance  $Z_{thJC}$  Characteristic



## ORDERING INFORMATION TABLE



- 1** - Vishay Semiconductors product
- 2** - Diode
- 3** - Essential part number
- 4** - 0 = standard recovery
- 5** -
  - N = stud normal polarity (cathode to stud)
  - R = stud reverse polarity (anode to stud)
- 6** - Voltage code x 100 =  $V_{RRM}$  (see Voltage Ratings table)
- 7** - P = stud base DO-9 (DO-205AB) 3/4" 16UNF-2A
- 8** - C = ceramic housing

LINKS TO RELATED DOCUMENTS	
Dimensions	<a href="http://www.vishay.com/doc?95301">www.vishay.com/doc?95301</a>

## DO-205AB (DO-9)

**DIMENSIONS** in millimeters (inches)

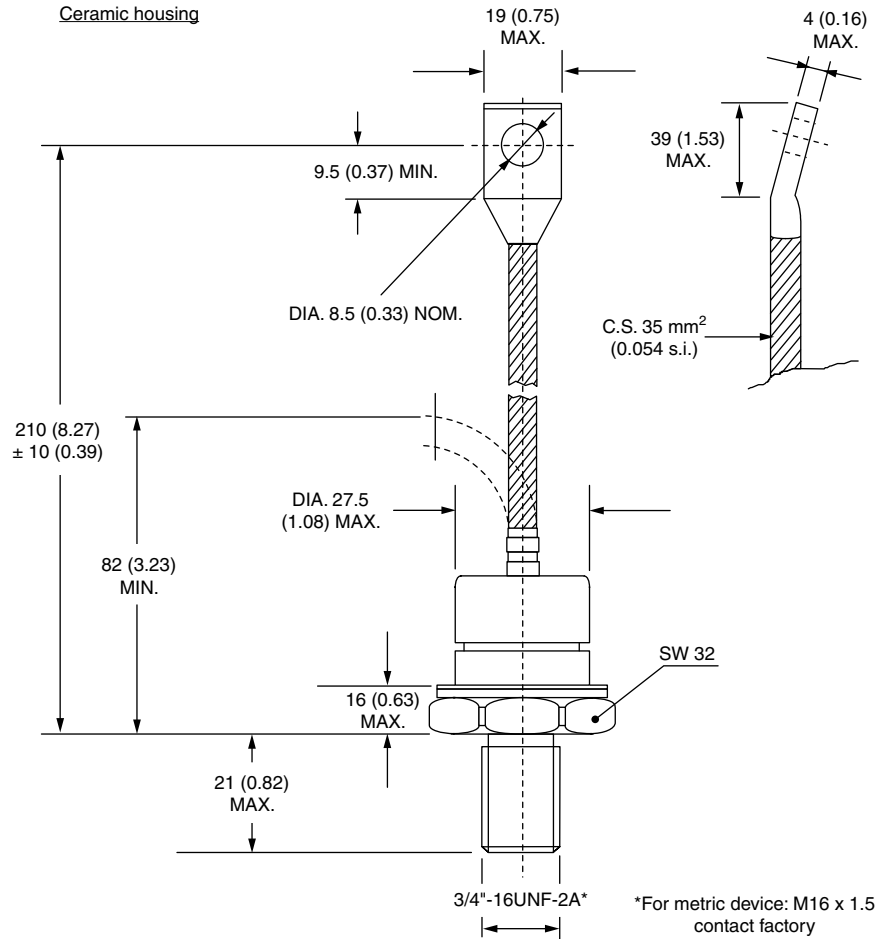



## Disclaimer

ALL PRODUCT, PRODUCT SPECIFICATIONS AND DATA ARE SUBJECT TO CHANGE WITHOUT NOTICE TO IMPROVE RELIABILITY, FUNCTION OR DESIGN OR OTHERWISE.

Vishay Intertechnology, Inc., its affiliates, agents, and employees, and all persons acting on its or their behalf (collectively, "Vishay"), disclaim any and all liability for any errors, inaccuracies or incompleteness contained in any datasheet or in any other disclosure relating to any product.

Vishay makes no warranty, representation or guarantee regarding the suitability of the products for any particular purpose or the continuing production of any product. To the maximum extent permitted by applicable law, Vishay disclaims (i) any and all liability arising out of the application or use of any product, (ii) any and all liability, including without limitation special, consequential or incidental damages, and (iii) any and all implied warranties, including warranties of fitness for particular purpose, non-infringement and merchantability.

Statements regarding the suitability of products for certain types of applications are based on Vishay's knowledge of typical requirements that are often placed on Vishay products in generic applications. Such statements are not binding statements about the suitability of products for a particular application. It is the customer's responsibility to validate that a particular product with the properties described in the product specification is suitable for use in a particular application. Parameters provided in datasheets and / or specifications may vary in different applications and performance may vary over time. All operating parameters, including typical parameters, must be validated for each customer application by the customer's technical experts. Product specifications do not expand or otherwise modify Vishay's terms and conditions of purchase, including but not limited to the warranty expressed therein.

Except as expressly indicated in writing, Vishay products are not designed for use in medical, life-saving, or life-sustaining applications or for any other application in which the failure of the Vishay product could result in personal injury or death. Customers using or selling Vishay products not expressly indicated for use in such applications do so at their own risk. Please contact authorized Vishay personnel to obtain written terms and conditions regarding products designed for such applications.

No license, express or implied, by estoppel or otherwise, to any intellectual property rights is granted by this document or by any conduct of Vishay. Product names and markings noted herein may be trademarks of their respective owners.

# Mouser Electronics

Authorized Distributor

Click to View Pricing, Inventory, Delivery & Lifecycle Information:

[Vishay:](#)

[VS-SD400N20PC](#) [VS-SD400N24PC](#) [VS-SD400R20PC](#) [VS-SD400R24PC](#) [VS-SD400N16PC](#) [VS-SD400R16PC](#)