

Dual Photovoltaic MOSFET Driver Solid-State Relay

DIP

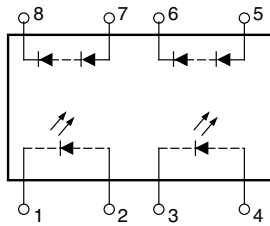

SMD

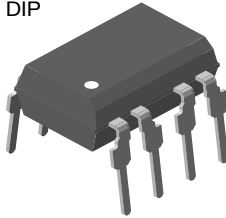
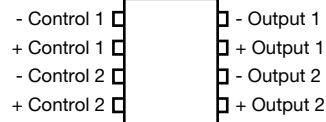
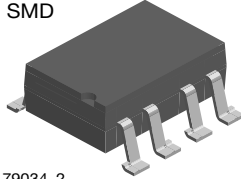

i179034_2

DESIGN SUPPORT TOOLS AVAILABLE



DESCRIPTION

The VO1263AB and VO1263AAC photovoltaic MOSFET driver consists of two LEDs optically coupled to two photodiode arrays. The photodiode array provides a floating source with adequate voltage and current to drive high power MOSFET transistors. Optical coupling provides a high I/O isolation voltage. In order to turn the MOSFET off, an external resistance (gate-to-source) is required for gate discharge.

FEATURES

- High open circuit voltage, up to 14.6 V typical
- High short circuit current, up to 42 μA typical
- Isolation test voltage 5300 V_{RMS}
- Logic compatible input
- High reliability
- Material categorization: for definitions of compliance please see www.vishay.com/doc?99912

RoHS
COMPLIANT

APPLICATIONS

- High side driver
- Solid-state relays
- Floating power supply
- Power control
- Data acquisition
- ATE
- Isolated switching

AGENCY APPROVALS

- [UL](#)
- [DIN EN 60747-5 \(VDE 0884-5\)](#)
- [BSI](#)
- [CQC](#)
- [FIMKO](#)

ORDERING INFORMATION

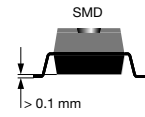
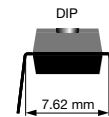
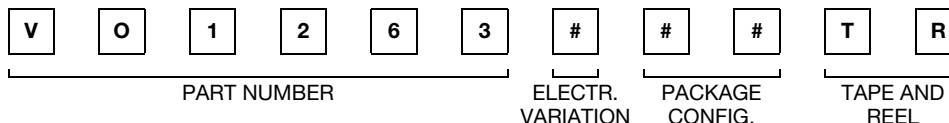

PACKAGE	UL, VDE, BSI, CQC, FIMKO
SMD-8	VO1263AAC
SMD-8, tape and reel	VO1263AACTR
DIP-8	VO1263AB

ABSOLUTE MAXIMUM RATINGS ($T_{\text{amb}} = 25\text{ }^{\circ}\text{C}$, unless otherwise specified)

PARAMETER	TEST CONDITION	SYMBOL	VALUE	UNIT
SSR				
LED input ratings continuous forward current		I_F	50	mA
LED input ratings reverse voltage	$I_R \leq 10\ \mu\text{A}$	V_R	5.0	V
Photodiode array reverse voltage	$I_R \leq 2.0\ \mu\text{A}$	V_R	100	V
Ambient operating temperature range		T_{amb}	-40 to +100	$^{\circ}\text{C}$
Storage temperature range		T_{stg}	-40 to +150	$^{\circ}\text{C}$
Pin soldering temperature	$t = 7.0\ \text{s max.}$	T_{slid}	270	$^{\circ}\text{C}$

Note

- Stresses in excess of the absolute maximum ratings can cause permanent damage to the device. Functional operation of the device is not implied at these or any other conditions in excess of those given in the operational sections of this document. Exposure to absolute maximum ratings for extended periods of the time can adversely affect reliability



ELECTRICAL CHARACTERISTICS ($T_{amb} = 25\text{ }^{\circ}\text{C}$, unless otherwise specified)						
PARAMETER	TEST CONDITION	SYMBOL	MIN.	TYP.	MAX.	UNIT
LED forward voltage	$I_F = 10\text{ mA}$	V_F	1.2	1.3	1.6	V
Detector reverse voltage	$I_R = 2.0\text{ }\mu\text{A}$	$V_{R(PDA)}$	-	350	-	V
Open circuit voltage (pins 5, 6 or 7, 8)	$I_F = 5.0\text{ mA}$	V_{OC}	-	13.73	-	V
	$I_F = 10\text{ mA}$	V_{OC}	10.3	14.27	16.5	V
	$I_F = 15\text{ mA}$	V_{OC}	-	14.50	-	V
	$I_F = 20\text{ mA}$	V_{OC}	-	14.70	-	V
	$I_F = 30\text{ mA}$	V_{OC}	-	14.94	-	V
Short circuit current (pins 5, 6 or 7, 8)	$I_F = 5.0\text{ mA}$	I_{SC}	2.7	4.47	-	μA
	$I_F = 10\text{ mA}$	I_{SC}	7	9.8	-	μA
	$I_F = 15\text{ mA}$	I_{SC}	11	15.33	-	μA
	$I_F = 20\text{ mA}$	I_{SC}	15	20.97	-	μA
	$I_F = 30\text{ mA}$	I_{SC}	21	32.4	-	μA

Note

- Minimum and maximum values are testing requirements. Typical values are characteristics of the device and are the result of engineering evaluations. Typical values are for information only and are not part of the testing requirements

SWITCHING CHARACTERISTICS ($T_{amb} = 25\text{ }^{\circ}\text{C}$, unless otherwise specified)						
PARAMETER	TEST CONDITION	SYMBOL	MIN.	TYP.	MAX.	UNIT
Turn-on time	$I_F = 20\text{ mA}$ ⁽¹⁾	t_{on}	-	16	-	μs
Turn-off time	$I_F = 20\text{ mA}$ ⁽¹⁾	t_{off}	-	472	-	μs

Note

- ⁽¹⁾ $f = 1.0\text{ kHz}$, pulse width = $100\text{ }\mu\text{s}$, load (R_L) = $1.0\text{ M}\Omega$, 15 pF ; measured at 90 % rated voltage (t_{on}), 10 % rated voltage (t_{off}). Actuation speed depends upon the external t_{on} and t_{off} circuitry and the capacitance of the MOSFET

SAFETY AND INSULATION RATINGS				
PARAMETER	TEST CONDITION	SYMBOL	VALUE	UNIT
Climatic classification	According to IEC 68 part 1		40 / 100 / 21	
Pollution degree	According to DIN VDE 0109		2	
Comparative tracking index	Insulation group IIIa	CTI	175	
Maximum rated withstanding isolation voltage	According to UL1577, $t = 1\text{ min}$	V_{ISO}	5300	V_{RMS}
Maximum transient isolation voltage	According to DIN EN 60747-5-5	V_{IOTM}	8000	V_{peak}
Maximum repetitive peak isolation voltage	According to DIN EN 60747-5-5	V_{IORM}	890	V_{peak}
Output safety power		P_{SO}	700	mW
Input safety current		I_{SI}	300	mA
Input safety temperature		T_S	175	$^{\circ}\text{C}$
Creepage distance	DIP-8, SMD-8		≥ 7	mm
Clearance distance			≥ 7	mm

Note

- This optocoupler is suitable for "safe electrical insulation" only within the safety ratings. Compliance with the safety ratings shall be ensured by means of suitable protective circuits



FUNCTIONAL DESCRIPTION

Fig. 1 outlines the IV characteristics of the illuminated photodiode array (PDA). For operation at voltages below V_{OC}, the PDA acts as a nearly constant current source. The actual region of operation depends upon the load.

The amount of current applied to the LED (pins 1 and 2 or 3 and 4) determines the amount of light produced for the PDA. For high temperature operation, more LED current may be required.

TYPICAL CHARACTERISTICS (T_{amb} = 25 °C, unless otherwise specified)

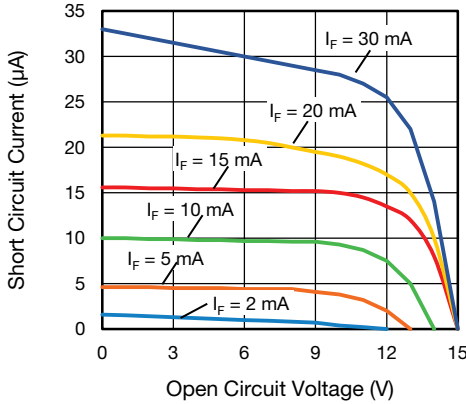

Fig. 1 - Short Circuit Current vs. Open Circuit Voltage

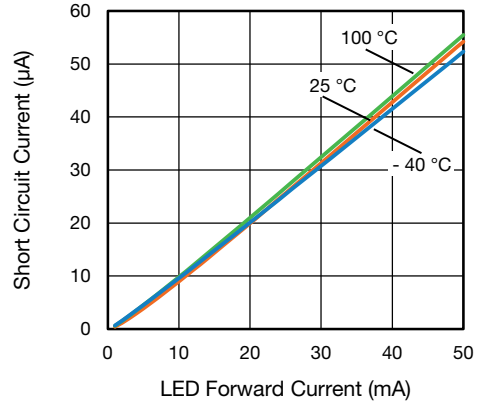

Fig. 3 - Short Circuit Current vs. LED Forward Current

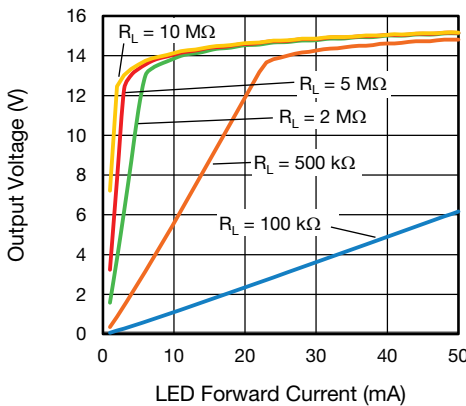

Fig. 2 - Output Voltage vs-LED Current

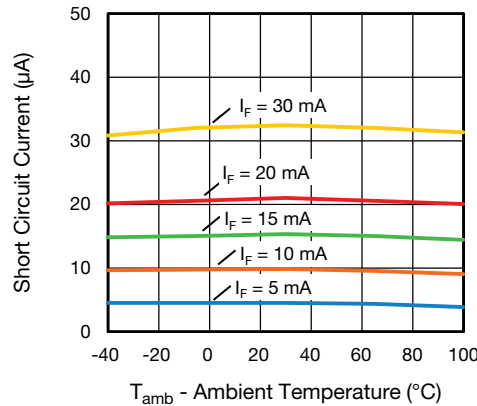

Fig. 4 - Short Circuit Current vs. Ambient Temperature

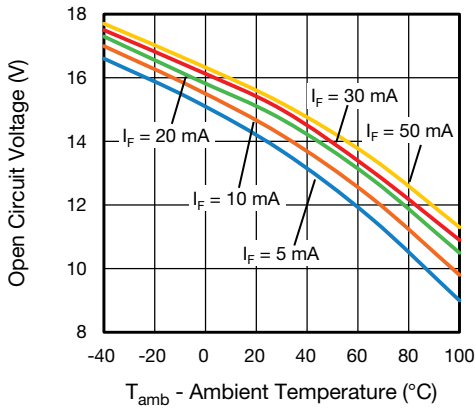

Fig. 5 - Open Circuit Voltage vs. Ambient Temperature

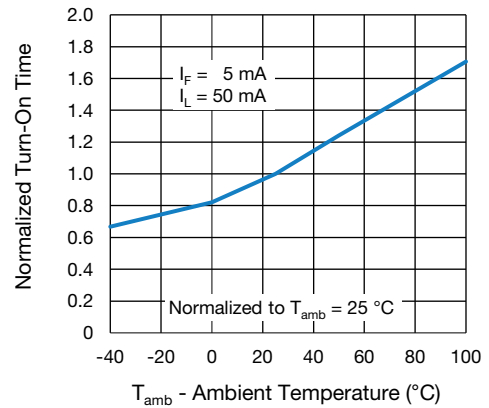

Fig. 8 - Normalized Turn-On Time vs. Ambient Temperature

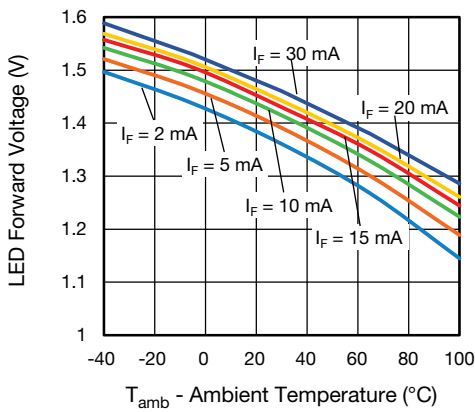

Fig. 6 - LED Forward Voltage vs. Ambient Temperature

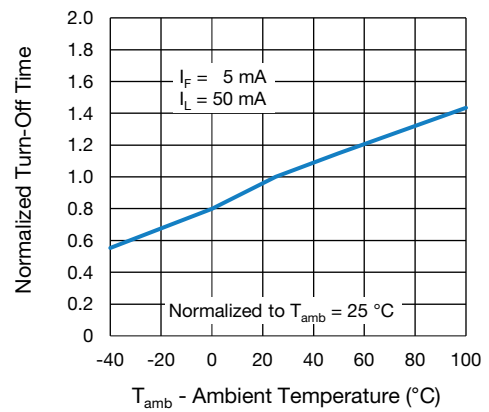

Fig. 9 - Normalized Turn-Off Time vs. Ambient Temperature

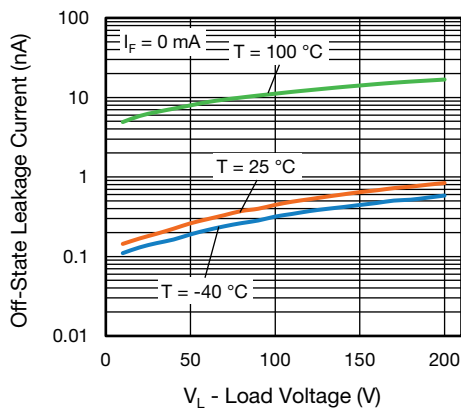

Fig. 7 - Leakage Current vs. Load Voltage

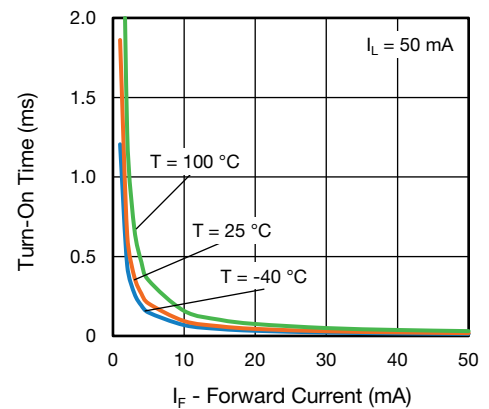

Fig. 10 - Turn-On Time vs. Forward Current

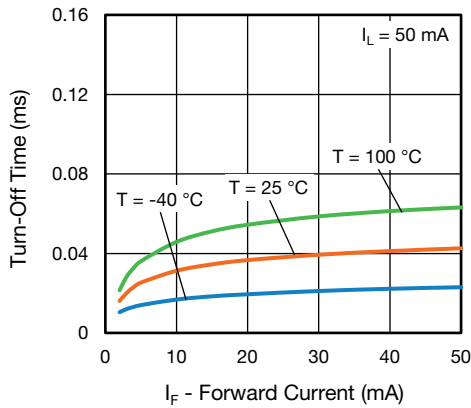
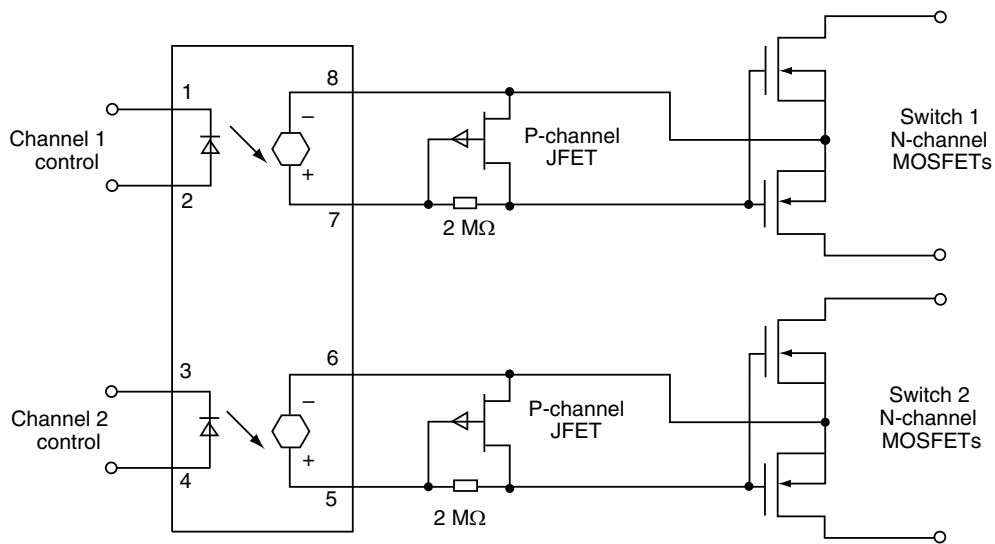

Fig. 11 - Turn-Off Time vs. Forward Current



ih1262cb_09

Fig. 12 - Typical Dual Form A Solid-State Relay Application



PACKAGE DIMENSIONS in millimeters

DIP

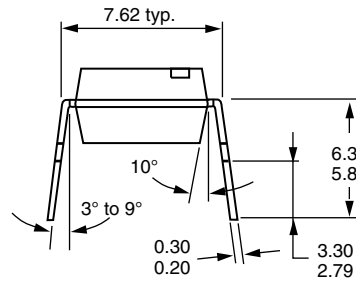
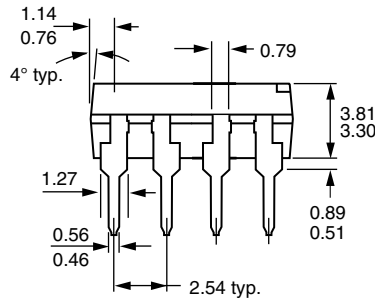
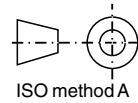
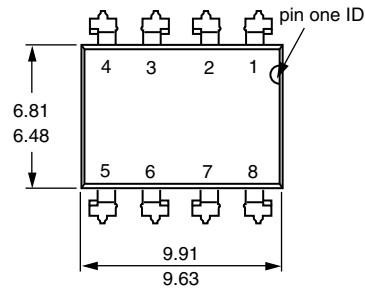

i178008

SMD

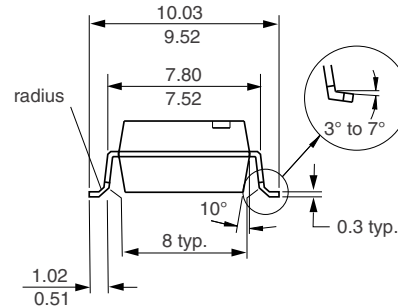
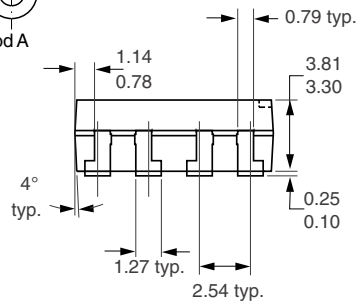
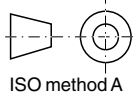
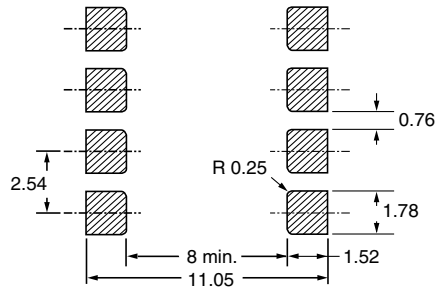
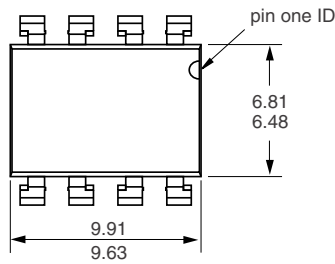

i178009

PACKAGE MARKING (example)

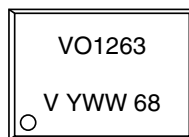
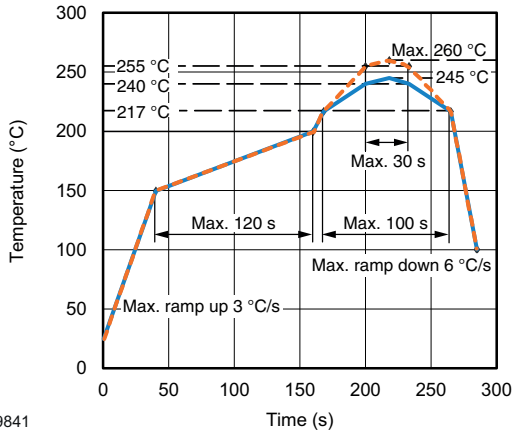

Fig. 13 - Example of VO1263AAC



SOLDER PROFILES



19841

Fig. 14 - Lead (Pb)-free Reflow Solder Profile According to J-STD-020 for SMD Devices

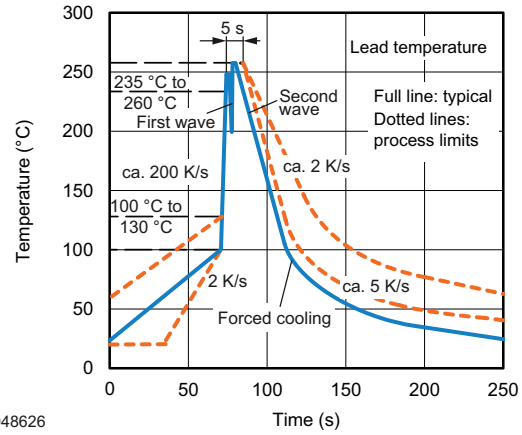

948626

Fig. 15 - Wave Soldering Double Wave Profile According to J-STD-020 for DIP Devices



Disclaimer

ALL PRODUCT, PRODUCT SPECIFICATIONS AND DATA ARE SUBJECT TO CHANGE WITHOUT NOTICE TO IMPROVE RELIABILITY, FUNCTION OR DESIGN OR OTHERWISE.

Vishay Intertechnology, Inc., its affiliates, agents, and employees, and all persons acting on its or their behalf (collectively, "Vishay"), disclaim any and all liability for any errors, inaccuracies or incompleteness contained in any datasheet or in any other disclosure relating to any product.

Vishay makes no warranty, representation or guarantee regarding the suitability of the products for any particular purpose or the continuing production of any product. To the maximum extent permitted by applicable law, Vishay disclaims (i) any and all liability arising out of the application or use of any product, (ii) any and all liability, including without limitation special, consequential or incidental damages, and (iii) any and all implied warranties, including warranties of fitness for particular purpose, non-infringement and merchantability.

Statements regarding the suitability of products for certain types of applications are based on Vishay's knowledge of typical requirements that are often placed on Vishay products in generic applications. Such statements are not binding statements about the suitability of products for a particular application. It is the customer's responsibility to validate that a particular product with the properties described in the product specification is suitable for use in a particular application. Parameters provided in datasheets and / or specifications may vary in different applications and performance may vary over time. All operating parameters, including typical parameters, must be validated for each customer application by the customer's technical experts. Product specifications do not expand or otherwise modify Vishay's terms and conditions of purchase, including but not limited to the warranty expressed therein.

Except as expressly indicated in writing, Vishay products are not designed for use in medical, life-saving, or life-sustaining applications or for any other application in which the failure of the Vishay product could result in personal injury or death. Customers using or selling Vishay products not expressly indicated for use in such applications do so at their own risk. Please contact authorized Vishay personnel to obtain written terms and conditions regarding products designed for such applications.

No license, express or implied, by estoppel or otherwise, to any intellectual property rights is granted by this document or by any conduct of Vishay. Product names and markings noted herein may be trademarks of their respective owners.

Mouser Electronics

Authorized Distributor

Click to View Pricing, Inventory, Delivery & Lifecycle Information:

Vishay:

[VO1263AACTR](#) [VO1263AAC](#) [VO1263AB](#)