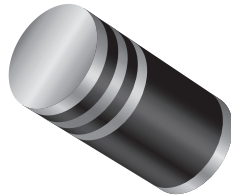

TRANSZorb® Transient Voltage Suppressors

GL41 (DO-213AB)

PRIMARY CHARACTERISTICS	
V_{BR} uni-directional	6.45 V to 210 V
V_{WM}	5.8 V to 171 V
P_{PPM}	400 W, 200 W
P_D	1.0 W
I_{FSM}	40 A
T_J max.	150 °C
Polarity	Uni-directional
Package	GL41 (DO-213AB)

FEATURES

- Plastic MELF package
- Ideal for automated placement
- Glass passivated pallet chip junction
- Available in uni-directional polarity only
- 400 W peak pulse power capability with a 10/1000 μ s waveform, repetitive rate (duty cycle): 0.01 %
- Excellent clamping capability
- Very fast response time
- Low incremental surge resistance
- Meets MSL level 1, per J-STD-020, LF maximum peak of 250 °C
- Material categorization: for definitions of compliance please see www.vishay.com/doc?99912

RoHS
COMPLIANT

TYPICAL APPLICATIONS

Use in sensitive electronics protection against voltage transients induced by inductive load switching and lighting on ICs, MOSFET, signal lines of sensor units for consumer, computer, industrial, and telecommunication.

MECHANICAL DATA

Case: GL41 (DO-213AB)

Molding compound meets UL 94 V-0 flammability rating
Base P/N-E3 - RoHS compliant, commercial grade

Terminals: matte tin plated leads, solderable per J-STD-002 and JESD 22-B102

E3 suffix meets JESD 201 class 1A whisker test

Polarity: blue band denotes the cathode which is positive with respect to the anode under normal TVS operation

MAXIMUM RATINGS ($T_A = 25$ °C unless otherwise noted)			
PARAMETER	SYMBOL	VALUE	UNIT
Peak pulse power dissipation with a 10/1000 μ s waveform ⁽¹⁾ (fig. 1)	P_{PPM}	400	W
Power dissipation on infinite heatsink at $T_L = 75$ °C	P_D	1.0	W
Peak pulse current with a 10/1000 μ s waveform ⁽¹⁾ (fig. 3)	I_{PPM}	See next table	A
Peak forward surge current, 8.3 ms half sine-wave uni-directional only ⁽²⁾	I_{FSM}	40	A
Maximum instantaneous forward voltage at 25 A for uni-directional only	V_F	3.5	V
Operating junction and storage temperature range	T_J, T_{STG}	-55 to +150	°C

Notes

⁽¹⁾ Non-repetitive current pulse, per fig. 3 and derated above $T_A = 25$ °C per fig. 2. Rating is 200 W above 91 V

⁽²⁾ Measured at 8.3 ms single half sine-wave or equivalent square wave duty cycle = 4 pulses per minute maximum



ELECTRICAL CHARACTERISTICS ($T_A = 25\text{ }^\circ\text{C}$ unless otherwise noted)								
DEVICE TYPE	BREAKDOWN VOLTAGE V_{BR} ⁽¹⁾ (V)		TEST CURRENT I_T (mA)	STAND-OFF VOLTAGE V_{WM} (V)	MAXIMUM REVERSE LEAKAGE AT V_{WM} I_D (μA)	MAXIMUM PEAK PULSE CURRENT I_{PPM} ⁽²⁾ (A)	MAXIMUM CLAMPING VOLTAGE AT I_{PPM} V_C (V)	MAXIMUM TEMPERATURE COEFFICIENT OF V_{BR} ($\%/^\circ\text{C}$)
	MIN.	MAX.						
TGL41-6.8A	6.45	7.14	10	5.80	1000	38.1	10.5	0.060
TGL41-7.5A	7.13	7.88	10	6.40	500	35.4	11.3	0.064
TGL41-8.2A	7.79	8.61	10	7.02	200	33.1	12.1	0.068
TGL41-9.1A	8.65	9.55	1.0	7.78	50.0	29.9	13.4	0.071
TGL41-10A	9.5	10.5	1.0	8.55	10.0	27.6	14.5	0.076
TGL41-11A	10.5	11.6	1.0	9.40	5.0	25.6	15.6	0.078
TGL41-12A	11.4	12.6	1.0	10.2	5.0	24.0	16.7	0.081
TGL41-13A	12.4	13.7	1.0	11.1	5.0	22.0	18.2	0.084
TGL41-15A	14.3	15.8	1.0	12.8	5.0	18.9	21.2	0.087
TGL41-16A	15.2	16.8	1.0	13.6	5.0	17.8	22.5	0.089
TGL41-18A	17.1	18.9	1.0	15.3	5.0	15.9	25.2	0.091
TGL41-20A	19.0	21.0	1.0	17.1	5.0	14.4	27.7	0.093
TGL41-22A	20.9	23.1	1.0	18.8	5.0	13.1	30.6	0.095
TGL41-24A	22.8	25.2	1.0	20.5	5.0	12.0	33.2	0.097
TGL41-27A	25.7	28.4	1.0	23.1	5.0	10.7	37.5	0.099
TGL41-30A	28.5	31.5	1.0	25.6	5.0	9.7	41.4	0.100
TGL41-33A	31.4	34.7	1.0	28.2	5.0	8.8	45.7	0.101
TGL41-36A	34.2	37.8	1.0	30.8	5.0	8.0	49.9	0.102
TGL41-39A	37.1	41.0	1.0	33.3	5.0	7.4	53.9	0.103
TGL41-43A	40.9	45.2	1.0	36.8	5.0	6.7	59.3	0.104
TGL41-47A	44.7	49.4	1.0	40.2	5.0	6.2	64.8	0.104
TGL41-51A	48.5	53.6	1.0	43.6	5.0	5.7	70.1	0.105
TGL41-56A	53.2	58.8	1.0	47.8	5.0	5.2	77.0	0.106
TGL41-62A	58.9	65.1	1.0	53.0	5.0	4.7	85.0	0.107
TGL41-68A	64.6	71.4	1.0	58.1	5.0	4.3	92.0	0.107
TGL41-75A	71.3	78.8	1.0	64.1	5.0	3.9	103	0.108
TGL41-82A	77.9	86.1	1.0	70.1	5.0	3.5	113	0.108
TGL41-91A	86.5	95.5	1.0	77.8	5.0	3.2	125	0.109
TGL41-100A	95.0	105	1.0	85.5	5.0	1.46	137	0.109
TGL41-110A	105	116	1.0	94.0	5.0	1.32	152	0.110
TGL41-120A	114	126	1.0	102	5.0	1.21	165	0.110
TGL41-130A	124	137	1.0	111	5.0	1.12	179	0.110
TGL41-150A	143	158	1.0	128	5.0	0.97	207	0.111
TGL41-160A	152	168	1.0	136	5.0	0.91	219	0.111
TGL41-170A	162	179	1.0	145	5.0	0.85	234	0.111
TGL41-180A	171	189	1.0	154	5.0	0.81	246	0.111
TGL41-200A	190	210	1.0	171	5.0	0.73	274	0.111

Notes

- (1) Pulse test: $t_p \leq 50\text{ ms}$
- (2) Surge current waveform per fig. 3 and derate per fig. 2
- (2) All terms and symbols are consistent with ANSI/IEEE C62.35

ORDERING INFORMATION (Example)				
PREFERRED PIN	UNIT WEIGHT (g)	PREFERRED PACKAGE CODE	BASE QUANTITY	DELIVERY MODE
TGL41-6.8A-E3/96	0.134	96	1500	7" diameter plastic tape and reel
TGL41-6.8A-E3/97	0.134	97	5000	13" diameter plastic tape and reel



RATINGS AND CHARACTERISTICS CURVES ($T_A = 25\text{ }^\circ\text{C}$ unless otherwise noted)

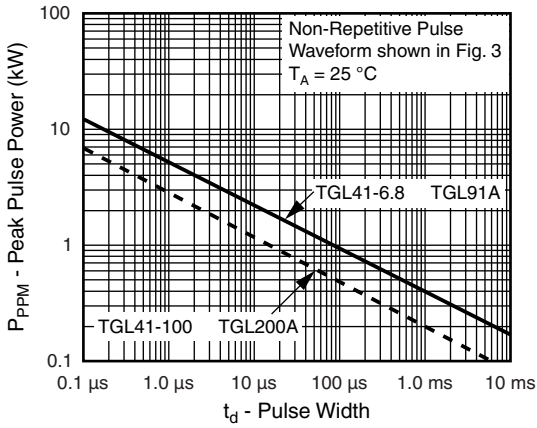

Fig. 1 - Peak Pulse Power Rating Curve

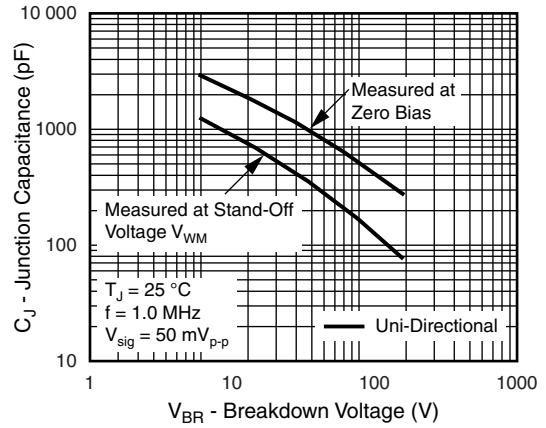

Fig. 4 - Typical Junction Capacitance

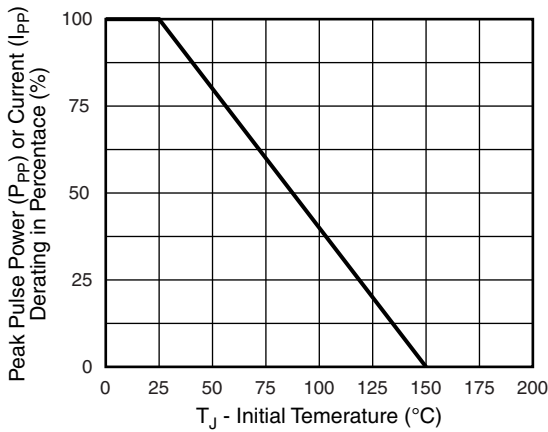

Fig. 2 - Pulse Power or Current vs. Initial Junction Temperature

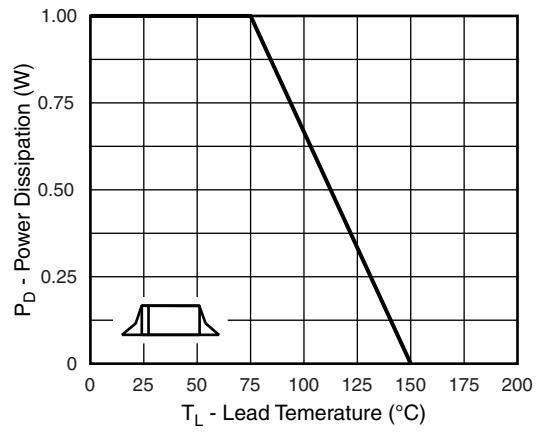

Fig. 5 - Power Derating Curve

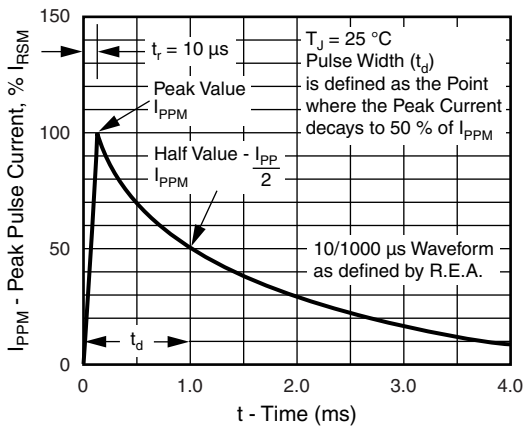

Fig. 3 - Pulse Waveform

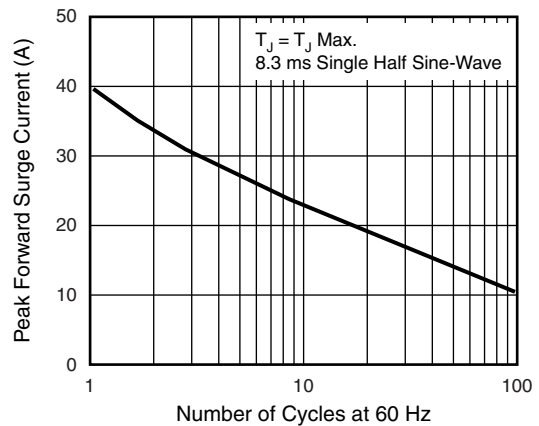
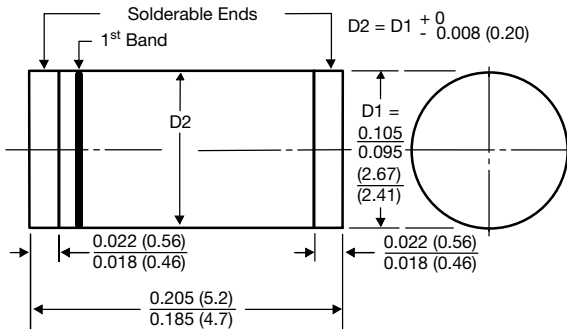

Fig. 6 - Maximum Non-Repetitive Peak Forward Surge Current
Uni-Directional Only



PACKAGE OUTLINE DIMENSIONS in inches (millimeters)

GL41 (DO-213AB)



1st band denotes type and positive end (cathode)

Mounting Pad Layout

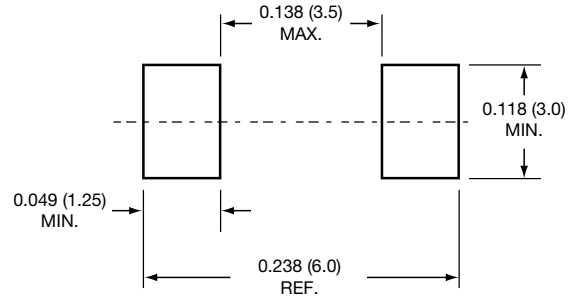



Disclaimer

ALL PRODUCT, PRODUCT SPECIFICATIONS AND DATA ARE SUBJECT TO CHANGE WITHOUT NOTICE TO IMPROVE RELIABILITY, FUNCTION OR DESIGN OR OTHERWISE.

Vishay Intertechnology, Inc., its affiliates, agents, and employees, and all persons acting on its or their behalf (collectively, "Vishay"), disclaim any and all liability for any errors, inaccuracies or incompleteness contained in any datasheet or in any other disclosure relating to any product.

Vishay makes no warranty, representation or guarantee regarding the suitability of the products for any particular purpose or the continuing production of any product. To the maximum extent permitted by applicable law, Vishay disclaims (i) any and all liability arising out of the application or use of any product, (ii) any and all liability, including without limitation special, consequential or incidental damages, and (iii) any and all implied warranties, including warranties of fitness for particular purpose, non-infringement and merchantability.

Statements regarding the suitability of products for certain types of applications are based on Vishay's knowledge of typical requirements that are often placed on Vishay products in generic applications. Such statements are not binding statements about the suitability of products for a particular application. It is the customer's responsibility to validate that a particular product with the properties described in the product specification is suitable for use in a particular application. Parameters provided in datasheets and / or specifications may vary in different applications and performance may vary over time. All operating parameters, including typical parameters, must be validated for each customer application by the customer's technical experts. Product specifications do not expand or otherwise modify Vishay's terms and conditions of purchase, including but not limited to the warranty expressed therein.

Except as expressly indicated in writing, Vishay products are not designed for use in medical, life-saving, or life-sustaining applications or for any other application in which the failure of the Vishay product could result in personal injury or death. Customers using or selling Vishay products not expressly indicated for use in such applications do so at their own risk. Please contact authorized Vishay personnel to obtain written terms and conditions regarding products designed for such applications.

No license, express or implied, by estoppel or otherwise, to any intellectual property rights is granted by this document or by any conduct of Vishay. Product names and markings noted herein may be trademarks of their respective owners.

Mouser Electronics

Authorized Distributor

Click to View Pricing, Inventory, Delivery & Lifecycle Information:

Vishay:

[TGL41-10/25](#) [TGL41-10/26](#) [TGL41-10/46](#) [TGL41-100A/26](#) [TGL41-100A/46](#) [TGL41-100A-E3/97](#) [TGL41-10A/26](#)
[TGL41-10A-E3/97](#) [TGL41-10-E3/97](#) [TGL41-110A/1](#) [TGL41-110A/26](#) [TGL41-110A-E3/1](#) [TGL41-110A-E3/97](#) [TGL41-11A-E3/97](#) [TGL41-12/26](#) [TGL41-120/46](#) [TGL41-120A/1](#) [TGL41-120A-E3/1](#) [TGL41-120A-E3/97](#) [TGL41-120-E3/97](#) [TGL41-12A/1](#) [TGL41-12A-E3/1](#) [TGL41-12A-E3/97](#) [TGL41-12-E3/97](#) [TGL41-13/25](#) [TGL41-130A/26](#) [TGL41-130A/46](#) [TGL41-130A-E3/97](#) [TGL41-13A/1](#) [TGL41-13A/25](#) [TGL41-13A-E3/1](#) [TGL41-13A-E3/97](#) [TGL41-13-E3/97](#) [TGL41-150/1](#) [TGL41-150/25](#) [TGL41-150/46](#) [TGL41-150A/1](#) [TGL41-150A/26](#) [TGL41-150A-E3/1](#) [TGL41-150A-E3/97](#) [TGL41-150-E3/1](#) [TGL41-150-E3/97](#) [TGL41-15A/1](#) [TGL41-15A-E3/1](#) [TGL41-15A-E3/97](#) [TGL41-15-E3/97](#) [TGL41-160A/1](#) [TGL41-160A/46](#) [TGL41-160A-E3/1](#) [TGL41-160A-E3/97](#) [TGL41-16A-E3/97](#) [TGL41-16-E3/97](#) [TGL41-18/26](#) [TGL41-180A/1](#) [TGL41-180A-E3/1](#) [TGL41-180A-E3/97](#) [TGL41-18A/1](#) [TGL41-18A-E3/1](#) [TGL41-18A-E3/97](#) [TGL41-18-E3/97](#) [TGL41-200A/1](#) [TGL41-200A-E3/1](#) [TGL41-200A-E3/97](#) [TGL41-200-E3/97](#) [TGL41-20A/1](#) [TGL41-20A/26](#) [TGL41-20A-E3/1](#) [TGL41-20A-E3/97](#) [TGL41-22A/25](#) [TGL41-22A-E3/97](#) [TGL41-22-E3/97](#) [TGL41-24A/1](#) [TGL41-24A/25](#) [TGL41-24A-E3/1](#) [TGL41-24A-E3/97](#) [TGL41-24-E3/97](#) [TGL41-27/26](#) [TGL41-27A/25](#) [TGL41-27A-E3/97](#) [TGL41-27-E3/97](#) [TGL41-30/46](#) [TGL41-30A/25](#) [TGL41-30A/46](#) [TGL41-30A-E3/97](#) [TGL41-30-E3/97](#) [TGL41-33A/1](#) [TGL41-33A-E3/1](#) [TGL41-33A-E3/97](#) [TGL41-33-E3/97](#) [TGL41-36/26](#) [TGL41-36A-E3/97](#) [TGL41-36-E3/97](#) [TGL41-39/26](#) [TGL41-39/46](#) [TGL41-39A/1](#) [TGL41-39A-E3/1](#) [TGL41-39A-E3/97](#) [TGL41-39-E3/97](#) [TGL41-43A/1](#) [TGL41-43A-E3/1](#)