

Features

- PLCC4 package.
- White package.
- Colorless clear window.
- Pb free
- RoHS compliant version.

Descriptions

- 120° viewing angle.
- Low power consumption.

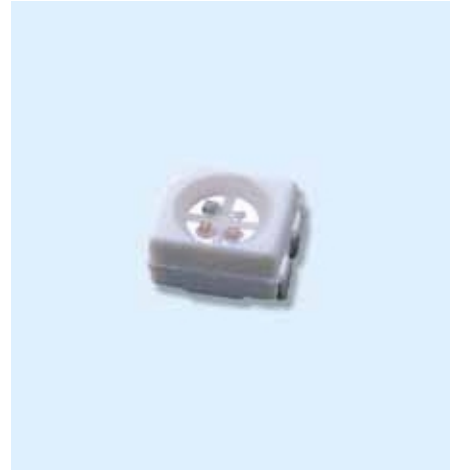

Applications

- Automotive: backlighting in dashboard and switch.
- Portable equipment.
- Flat backlight for LCD's, switches and symbols.
- General use.

Device Selection Guide

Chip			Lens Color
Type	Material	Emitted Color	
R6	AlGaInP	Brilliant Red	Water Clear
GH	InGaN	Brilliant Green	
BH	InGaN	Blue	

Package Outline Dimensions

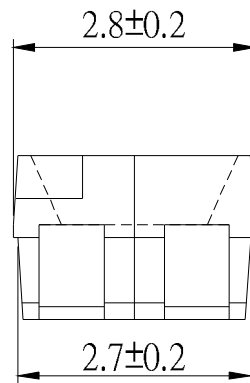
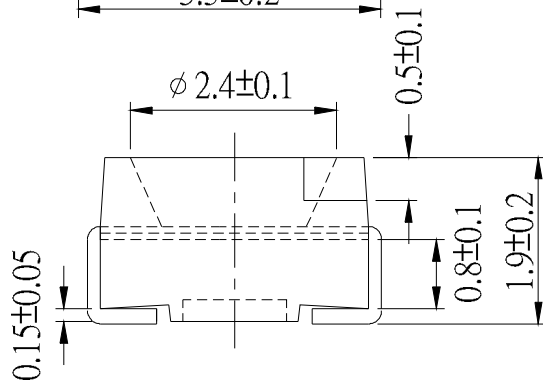
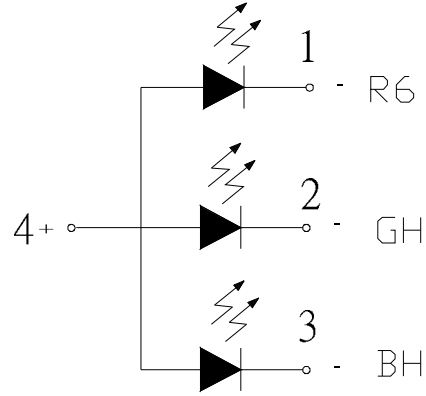
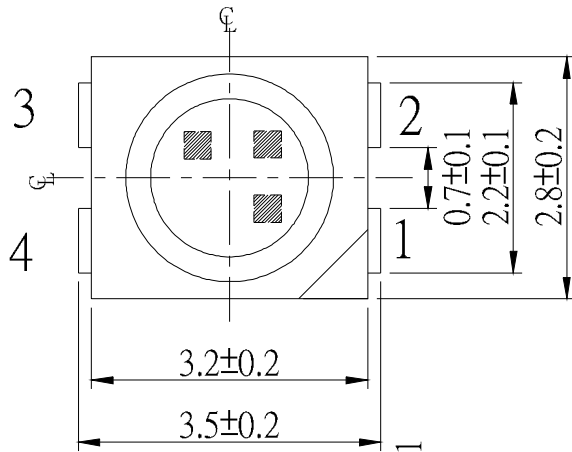

For reflow soldering(propose)

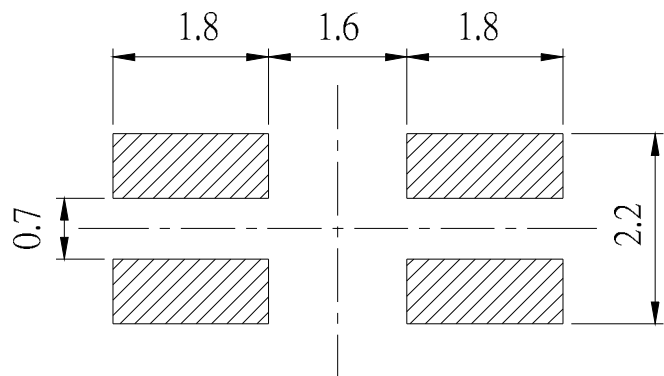
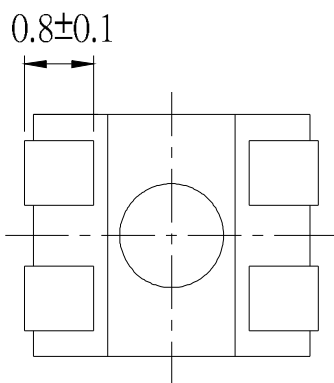

Notes: All dimensions are in millimeters.

Absolute Maximum Ratings (Ta=25°C)

Parameter	Symbol	Rating		Unit
Reverse Voltage	V _R	5		V
Forward Current	I _F	R6	25	mA
		GH	25	
		BH	25	
Operating Temperature	Topr	-40 ~ +85		°C
Storage Temperature	Tstg	-40~ +100		°C
Electrostatic Discharge(HBM)	ESD	R6	2000	V
		GH	150	
		BH	150	
Power Dissipation	Pd	R6	120	mW
		GH	110	
		BH	110	
Peak Forward Current(Duty 1/10 @ 1KHz)	I _{FP}	R6	100	mA
		GH	100	
		BH	100	
Soldering Temperature	Tsol	Reflow Soldering : 260 °C for 10 sec. Hand Soldering : 350 °C for 3 sec.		

Specific binning requirements- please contact our home office

Electro-Optical Characteristics (Ta=25°C)

Parameter	Symbol	Min.	Typ.		Unit	Condition
Luminous Intensity	I _v	R6	112	-----	285	mcd I _F =20mA
		GH	180	-----	450	
		BH	72	-----	180	
Peak Wavelength	λ _p	R6	-----	632	-----	nm I =20mA
		GH	-----	518	-----	
		BH	-----	468	-----	
Dominant Wavelength	λ _d	R6	621	-----	631	nm I _F =20mA
		GH	520	-----	530	
		BH	465	-----	475	
Spectrum Radiation Bandwidth	Δλ	R6	-----	20	-----	nm I _F =20mA
		GH	-----	35	-----	
		BH	-----	35	-----	
Forward Voltage	V _F	R6	-----	2.0	2.4	V I _F =20mA
		GH	-----	3.4	3.95	
		BH	-----	3.4	3.95	
Viewing Angle	2θ 1/2	-----	120	-----	deg	I _F =20mA
Reverse Current	I _R	R6	-----	-----	10	μA V _R =5V
		GH	-----	-----	50	
		BH	-----	-----	50	

*The luminous intensity data did not including ±10% testing tolerance.

Bin Rang Of Luminous Intensity

Chip	Bin	Min	Max	Unit	Condition
R6	R	112	180	mcd	I _F =20mA
	S	180	285		
GH	S	180	285		
	T	285	450		
BH	Q	72	112		
	R	112	180		

Bin Rang Of Dominate Wavelength

Chip	Bin	Min	Max	Unit	Condition
R6	FF1	621	626	nm	I =20mA
	FF2	626	631		
GH	X	520	525		
	Y	525	530		
BH	X	465	470		
	Y	470	475		

*The luminous intensity data did not including $\pm 10\%$ testing tolerance.

Typical Electro-Optical Characteristics Curves (R6)

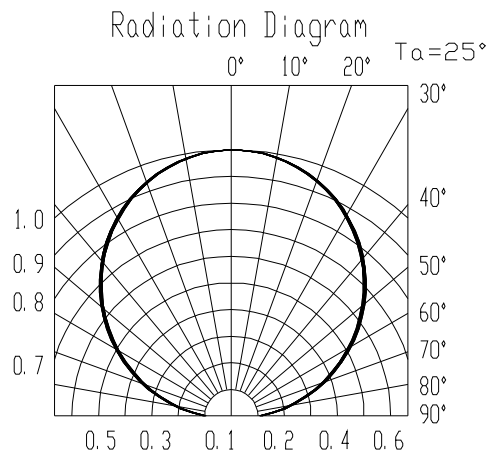
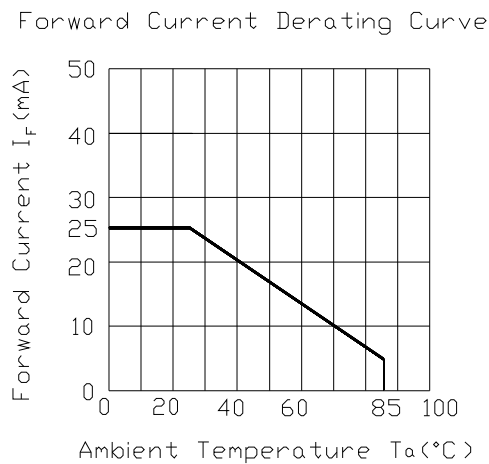
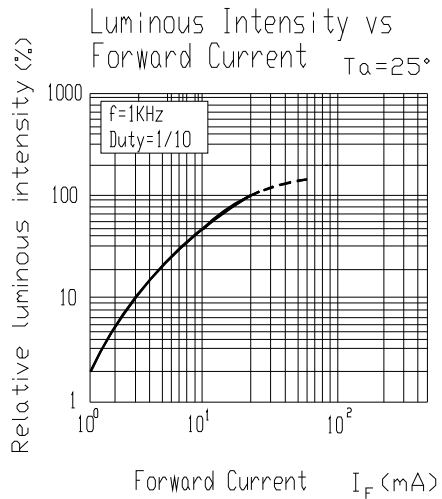
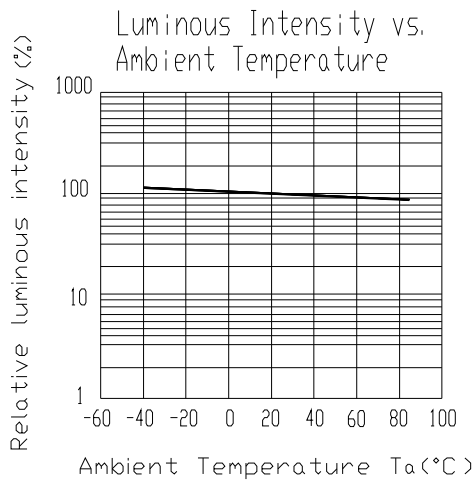
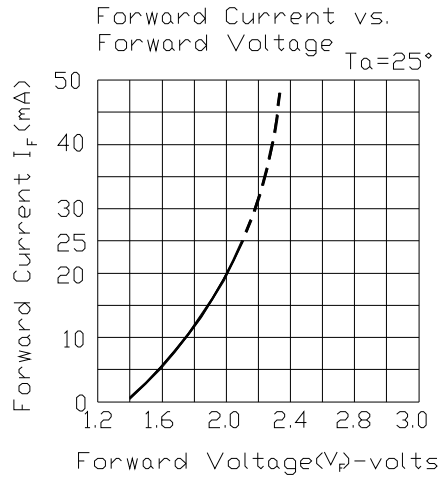
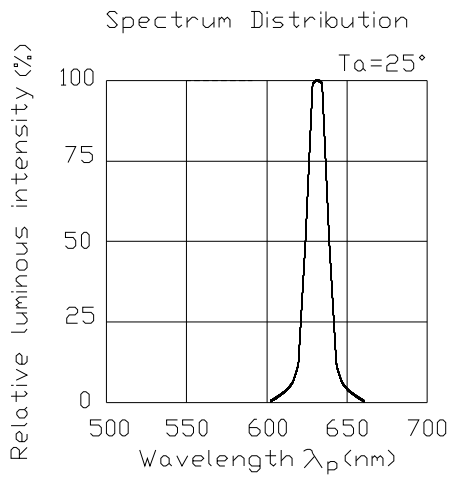

Typical Electro-Optical Characteristics Curves (GH)

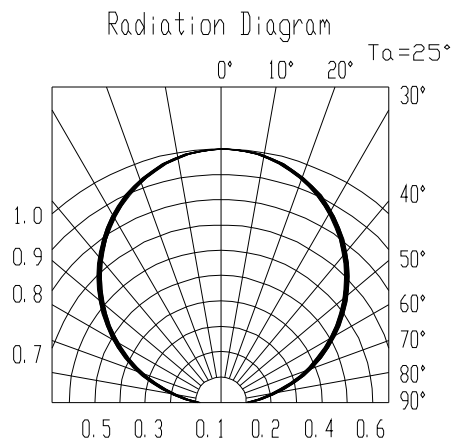
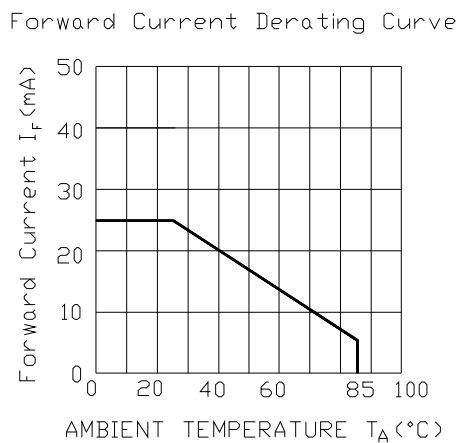
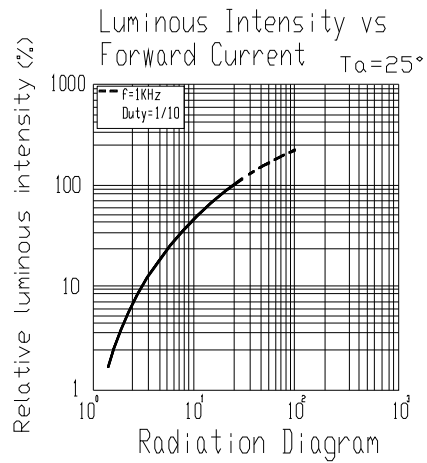
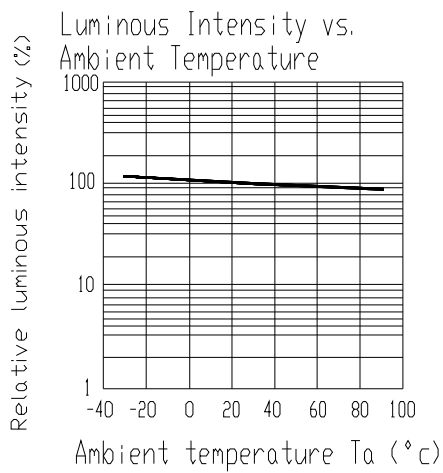
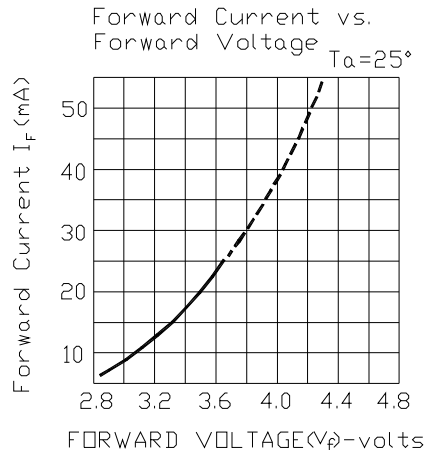
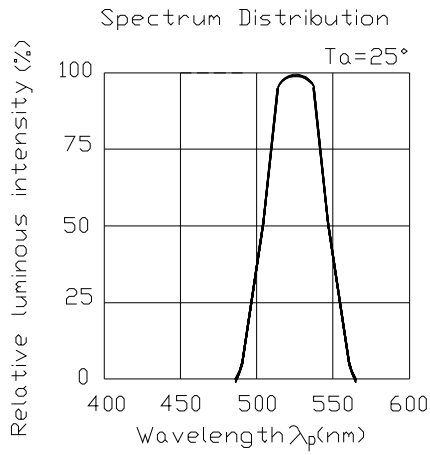

Typical Electro-Optical Characteristics Curves (BH)

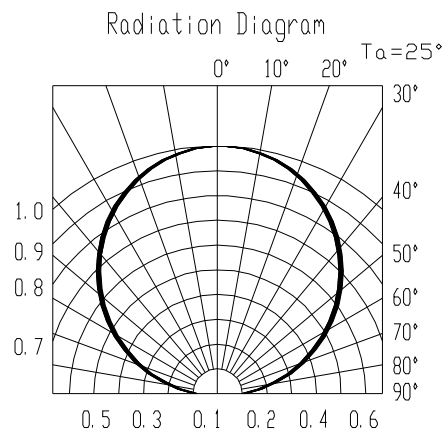
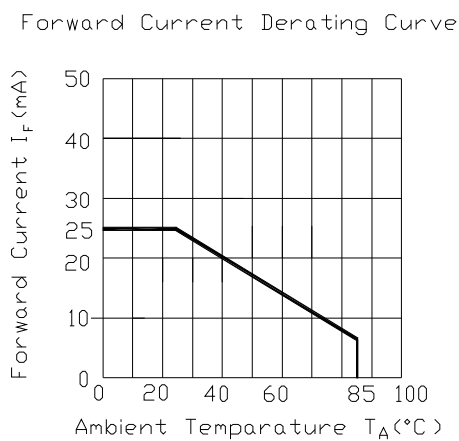
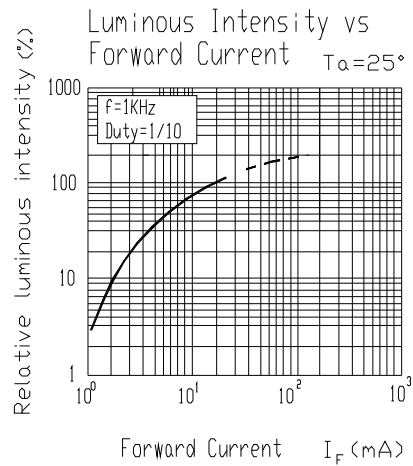
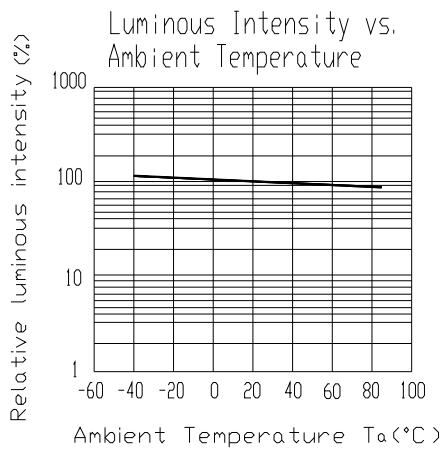
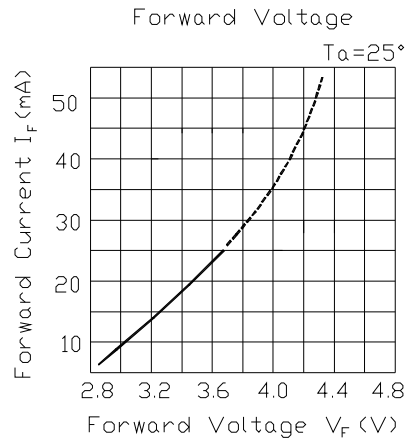
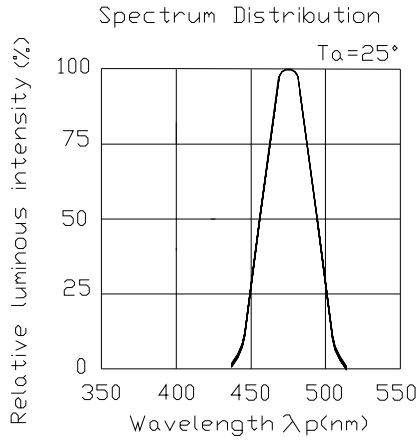

Reel Dimensions

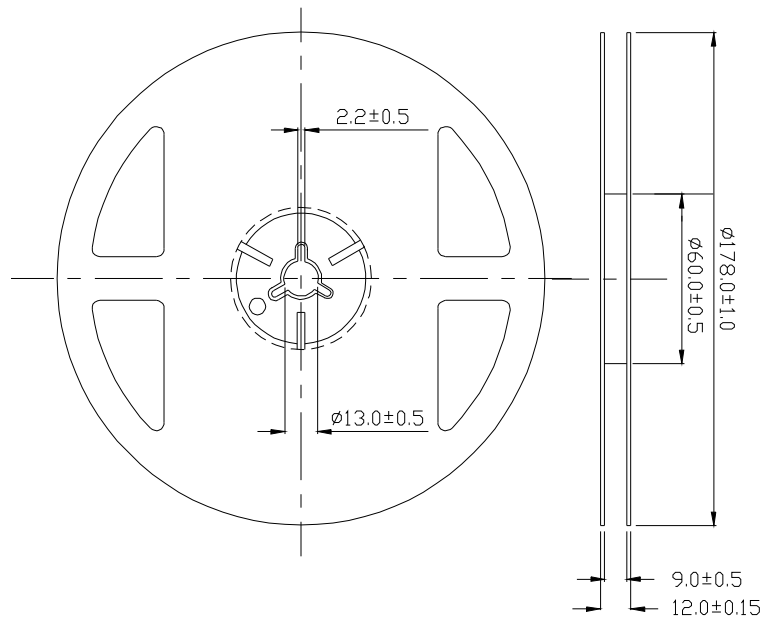

Note: Tolerances Unless Dimension ± 0.1 mm ,Unit = mm

Carrier Tape Dimensions: Loaded quantity 2000 PCS per reel.

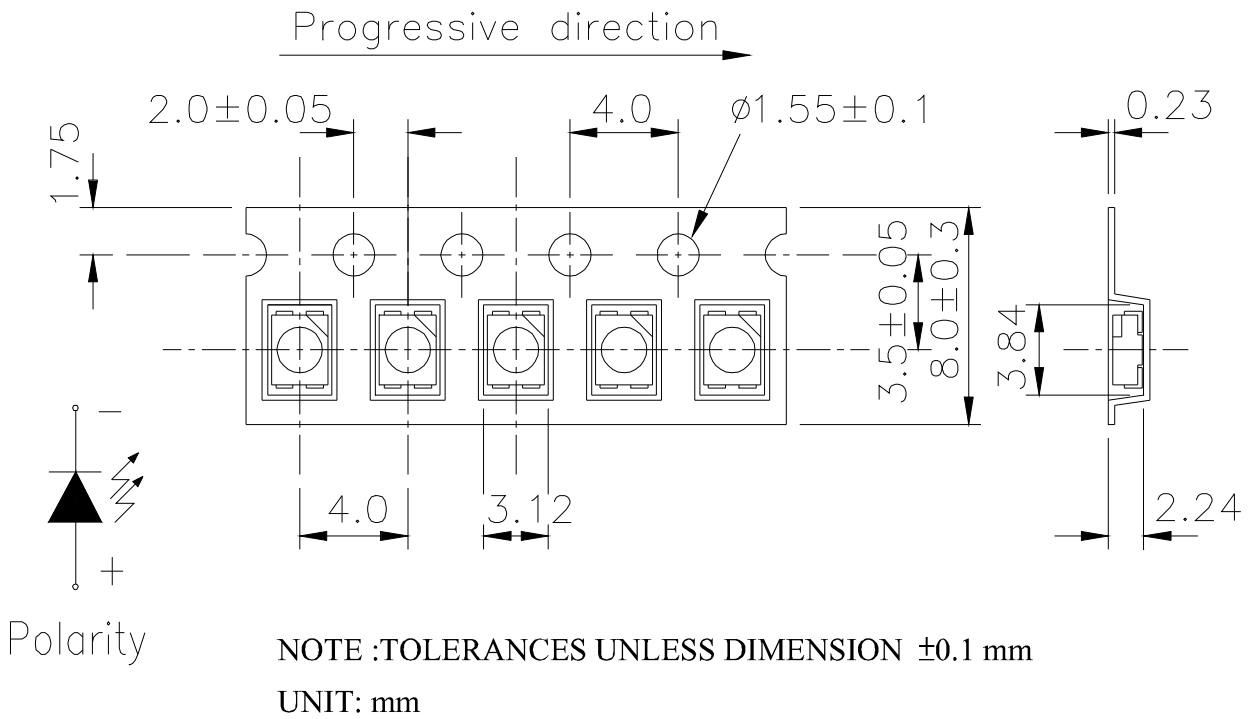

Moisture Resistant Packaging

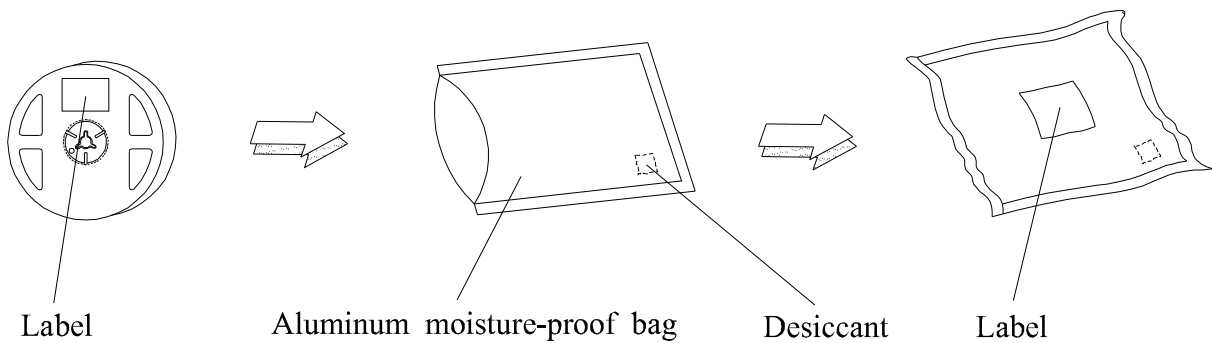

Reliability Test Items And Conditions

The reliability of products shall be satisfied with items listed below.

Confidence level : 90%

LTPD : 10%

1	Reflow Soldering	Temp. : 260°C ±5°C Min. 5sec.	6 Min.	22 PCS.	0/1
2	Temperature Cycle	H : +100°C 15min ∫ 5 min L : -40°C 15min	300 Cycles	22 PCS.	0/1
3	Thermal Shock	H : +100°C 5min ∫ 10 sec L : -10°C 5min	300 Cycles	22 PCS.	0/1
4	High Temperature Storage	Temp. : 100°C	1000 Hrs.	22 PCS.	0/1
5	Low Temperature Storage	Temp. : -40°C	1000 Hrs.	22 PCS.	0/1
6	DC Operating Life	IF = 20 mA	1000 Hrs.	22 PCS.	0/1
7	High Temperature / High Humidity	85°C/85%RH.	1000 Hrs.	22 PCS.	0/1
1	Reflow Soldering	Temp. : 260°C ±5°C Min. 5sec.	6 Min.	22 PCS.	0/1

Precautions For Use

1. Customer must apply resistors for protection, otherwise a slight voltage shift will cause a big current change .

2. Storage

2.1 Do not open moisture proof bag before the products are ready to use

2.2 Before opening the package: The LEDs should be kept at 30°C or less and 90%RH or less.

2.3 After opening the package: The LED's floor life is 1 year under 30 deg C or less and 60% RH or less.

If unused LEDs remain, it should be stored in moisture proof packages.

2.4 If the moisture absorbent material (silica gel) has faded away or the LEDs have exceeded the storage time, baking treatment should be performed using the following conditions.

Baking treatment : $60\pm 5^{\circ}\text{C}$ for 24 hours.

3. Soldering Condition

3.1 Pb free solder temperature profile

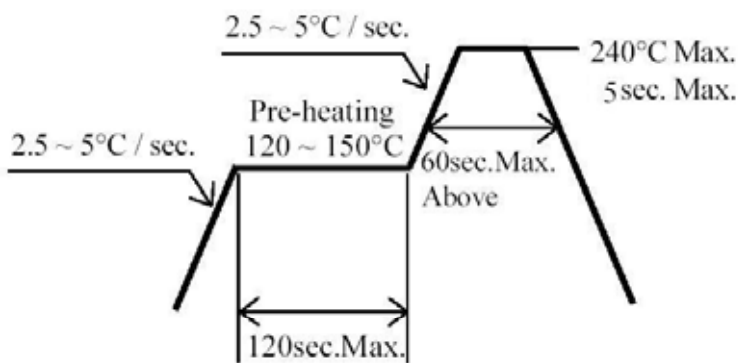

3.2 Reflow soldering should not be done more than two times.

3.3 When soldering, do not put stress on the LEDs during heating.

3.4 After soldering, do not warp the circuit board.

4. Soldering Iron

Each terminal is to go to the tip of soldering iron temperature less than 350°C for 3 seconds within once in less than the soldering iron capacity 25W. Leave two seconds and more intervals, and do soldering of each terminal. Be careful because the damage of the product is often started at the time of the hand solder.

Mouser Electronics

Authorized Distributor

Click to View Pricing, Inventory, Delivery & Lifecycle Information:

VCC:

[VAOS-SP4RGB4](#)