



# IQS156 Datasheet

## IQ Switch<sup>®</sup> - ProxSense<sup>®</sup> Series

Minimalist Capacitive Sensor with Compensation for Sensitivity Reducing Objects

### Unparalleled Features

- ↳ Sub 6 $\mu$ A current consumption
- ↳ Automatic tuning for optimal operation in various environments

The IQS156 ProxSense<sup>®</sup> IC is a fully integrated six channel capacitive contact and proximity sensor with market leading sensitivity and automatic tuning to the sense electrodes. The IQS156 provides a minimalist implementation requiring as few as 2 external components. The device is ready for use in a large range of applications while programming options allow customisation for specialized applications.

### Main Features

- ↳ 6 Channel input device
- ↳ I<sup>2</sup>C data output
- ↳ ATI: Automatic tuning to optimum sensitivity
- ↳ Supply Voltage 3V to 5.5V
- ↳ 8 Power Modes (6 $\mu$ A min)
- ↳ Internal voltage regulator and reference capacitor
- ↳ Large proximity detection range
- ↳ Automatic drift compensation
- ↳ Development and Programming tools available (VisualProxSense and USBProg)
- ↳ Small outline MSOP-10

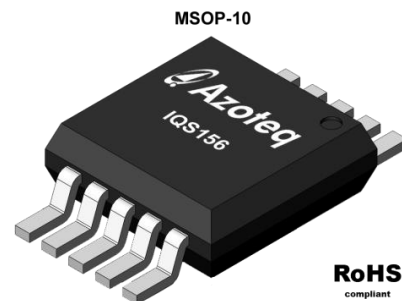

RoHS  
compliant

IQS143 MSOP10

Representations only, not  
actual markings

### Applications

- ↳ White goods and appliances
- ↳ Office equipment, toys, sanitary ware
- ↳ Flame proof, hazardous environment Human Interface Devices
- ↳ Proximity detection that enables backlighting activation (Azoteq Patented)
- ↳ Wake-up from standby applications
- ↳ Replacement for electromechanical switches
- ↳ GUI trigger on proximity detection.

### Available options

T <sub>A</sub>	MSOP-10
-40°C to 85°C	IQS156



## Functional Overview

### 1 Introduction

The IQS156 is a six channel projected capacitive proximity and touch sensor featuring internal voltage regulator and reference capacitor ( $C_s$ ).

The device has five dedicated input pins for the connection of the sense electrodes, which comprises of three receivers, and two transmitters. Two output pins are used for serial data communication through the I2C protocol.

The devices automatically tracks slow varying environmental changes via various filters, detect noise and has an automatic Automatic Tuning Implementation (ATI) to tune the device for optimal sensitivity.

#### 1.1 Applicability

All specifications, except where specifically mentioned otherwise, provided by this datasheet are applicable to the following ranges:

- ⚡ Temperature -40°C to +85°C
- ⚡ Supply voltage ( $V_{DDHI}$ ) 3V to 5.5V

#### 1.2 Pin-outs

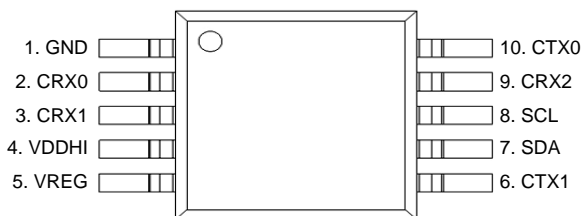

Figure 1.1 IQS156 Pin-outs.

Table 1.1 IQS156 Pin-outs.

Pin	I <sup>2</sup> C	Function
1	GND	Ground
4	VDDHI	Power Input
5	VREG	Regulator Pin
2	CRX0	Receiver Electrode
3	CRX1	Receiver Electrode
9	CRX2	Receiver Electrode
10	CTX0	Transmitter Electrode
6	CTX1	Transmitter Electrode
7	SDA	I <sup>2</sup> C Data
8	SCL	I <sup>2</sup> C Clock

## 2 Analogue Functionality

The analogue circuitry measures the capacitance of the sense electrodes attached to the C<sub>x</sub> pins through a charge transfer process that is periodically initiated by the digital circuitry. The measuring process is referred to a conversion and consists of the discharging of C<sub>s</sub> and C<sub>x</sub>, the charging of C<sub>x</sub> and then a series of charge transfers from C<sub>x</sub> to C<sub>s</sub> until a trip voltage is reached. The number of charge transfers required to reach the trip voltage is referred to as the Count Values (CS).

The capacitance measurement circuitry makes use of an internal C<sub>s</sub> and voltage reference ( $V_{REG}$ ).

The analogue circuitry further provides functionality for:



- ☞ Power on reset (POR) detection.
- ☞ Brown out detection (BOD).

### 3 Digital Functionality

The digital processing functionality is responsible for:

- ☞ Management of BOD and WDT events.
- ☞ Initiation of conversions at the selected rate.
- ☞ Processing of CS and execution of algorithms.

- ☞ Monitoring and automatic execution of the ATI algorithm.
- ☞ Signal processing and digital filtering.
- ☞ Detection of PROX and TOUCH events.
- ☞ Managing outputs of the device.
- ☞ Managing serial communications.

### Detailed Description

### 4 Reference Design

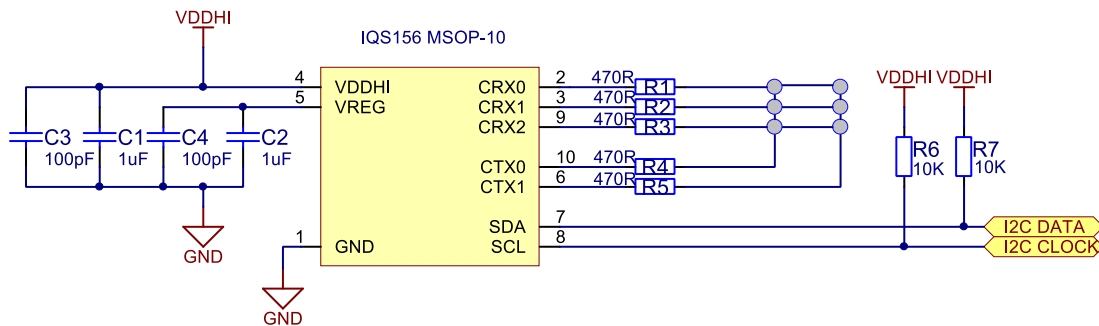

Figure 4.1 Reference Design.

- ☞ Use C3 and C4 for added RF immunity.
- ☞ Place C1-C4 as close as possible to IC, connected to good GND.
- ☞ R6 and R7 used as pull up resistors for I<sup>2</sup>C protocol.

Figure 4.2 Output in active low.

### 5 High Sensitivity

Through patented design and advanced signal processing, the device is able to provide extremely high sensitivity to detect Proximity. This enables designs that can detect

proximities at distances that cannot be equalled by most other products. When the device is used in environments where noise or ground effects exist that lower the sensitivity, a reduced proximity threshold is proposed to ensure reliable functioning of the sensor. The high sensitivity allows the device to sense



accurately through overlays with low dielectric constants like wood or even air gaps.

## 6 Adjustable Proximity Threshold

The IQS156 has a default proximity threshold of 4. The proximity threshold is selected by the designer (1 to 64) to obtain the desired sensitivity and noise immunity through the I<sup>2</sup>C serial interface. The proximity event is triggered based on the selected proximity threshold; the CS, LTA (Long Term Average) and LTN (Long Term Noise) filter. The threshold is expressed in terms of counts; the same as CS.

A proximity event is identified when for at least 4 consecutive samples the following equation holds:

$$P_{TH} \leq LTA - CS$$

Where LTA is the Long Term Average

## 7 Adjustable Touch Thresholds

The IQS156 has a default touch threshold of 96 (for all six channels). The touch threshold is selected by the designer to obtain the desired touch sensitivity and is selectable in the memory map, individually for each channel.

The touch event is triggered based on T<sub>TH</sub>, CS and LTA. A touch event is identified when for at least 4 consecutive samples the following equation holds:

$$T_{TH} \leq LTA - CS$$

With lower average CS (therefore lower LTA) values the touch threshold will be lower and vice versa.

## 8 Charge Transfers

The IQS156 charges in 7 timeslots, with one internal Cs capacitor. The charge sequence is shown in Figure 8.1, where CH0 is the Prox channel, and charges before each of the 6 input channels.

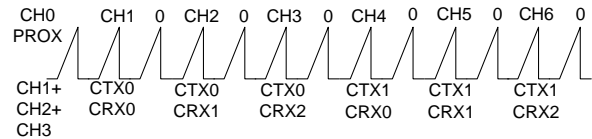

Figure 8.1 IQS156 Charge transfer.

## 9 Data Streaming

The IQS156 device interfaces to a master controller via a 2 wire serial interface bus that is I<sup>2</sup>C™ compatible.

The IQS156 can only function as a slave device on the bus. The bus must be controlled by a master device which generates the serial clock (SCL), controls bus access, and generates the START and STOP conditions.

The serial clock (SCL) and serial data lines (SDA) are open-drain and therefore must be pulled high to the operating voltage with a pull-up resistor (typically 10k).

### 9.1 Bus Characteristics

The following bus protocol has been defined:

- ⌚ Data transfer may only be initiated when the bus is not busy
- ⌚ During data transfer the data line must remain stable whenever the clock line is HIGH. Changes in the data line while the clock is HIGH will be interpreted as START and STOP conditions.

The following conditions have been defined for the bus (refer to Figure 9.1):

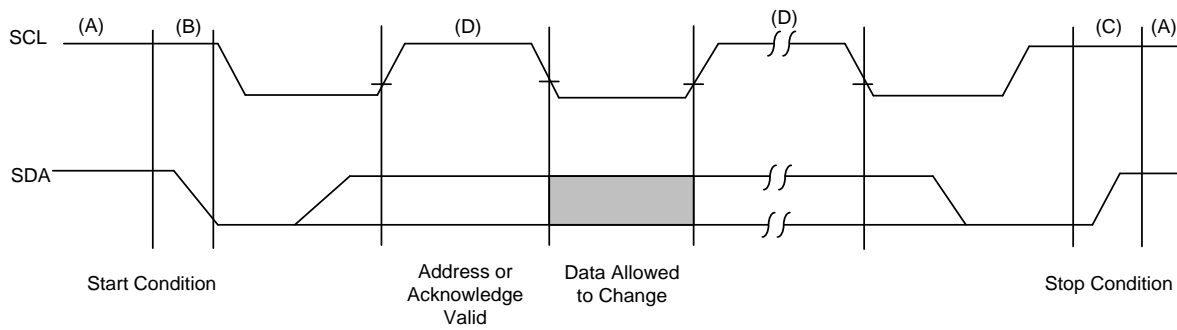

**Figure 9.1 Data Transfer Sequence on the Serial Bus.**

### 9.1.2 Bus Idle (A)

The SCL and SDA lines are both HIGH.

### 9.1.3 START Condition (B)

A start condition is implemented as a HIGH to LOW transition of SDA, while the SCL is HIGH. All serial communication must be preceded by a START condition.

### 9.1.4 STOP Condition (C)

A stop condition is implemented as a LOW to HIGH transition of SDA, while the SCL is HIGH. All serial communication must be ended by a STOP condition. NOTE: When a STOP condition is sent, the device will exit the communications window and continue with conversions.

### 9.1.5 Data Valid (D)

The state of the SDA line represents valid data when, after a START condition, the SDA is stable for the duration of the HIGH period of the clock signal.

The data on the line must be changed during the LOW period of the clock signal. There is one clock pulse per bit of data.

Each data transfer is initiated with a START condition and terminated with a STOP condition.

### 9.1.6 Acknowledge

The slave device must acknowledge (ACK) after the reception of each byte. The master device must generate an extra (9th) clock pulse which is associated with this acknowledge bit. The device that acknowledges, has to pull down the SDA line during the acknowledge clock pulse. NOTE:

The IQS156 does not generate any acknowledge bits while it is not in its communication window.

## 9.2 Acknowledge Polling

The IQS156 does not have a RDY pin, thus ACK polling must be used to determine when the device is ready for communication. The device will not acknowledge during a conversion cycle.

Once a stop condition is sent by the master the device will perform the next conversion cycle. ACK polling can be initiated at any time during the conversion cycle to determine if the device has entered its communication window.

To perform ACK polling the master sends a start condition followed by the control byte. If the device is still busy then no ACK will be returned. If the device has completed its cycle the device will return an ACK, and the master can proceed with the next read or write operation (refer to Figure 9.2).

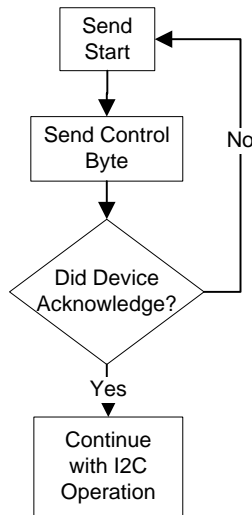

Figure 9.2 ACK Polling.

### 9.3 Control Byte Format

A control byte is the first byte received following the start condition from the master device. The control byte consists of a 7 bit device address and the Read/ Write indicator bit (refer to Figure 9.3).

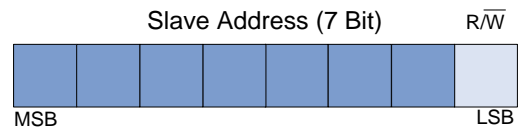

Figure 9.3 Control Byte Format.

### 9.4 Sub addressing

Each slave device on the serial bus requires a unique 7 bit device identifier. When the control byte is sent by the master the device will be able to determine if it is the intended recipient of a data transaction. The IQS156 address selection is controlled with OTP fuse selection. Four addresses are available, and can be programmed by USBProg.

Table 9.1 I<sup>2</sup>C Sub Addresses.

SA1	SA0	Address (7-bit)
0	0	0x40
0	1	0x41
1	0	0x42
1	1	0x43

### 9.5 Memory Mapping

Address Size(Bytes)

00h-0Fh	16	<table border="1"> <tr> <td rowspan="3" style="text-align: center; vertical-align: middle;">Device Information</td> <td>R/W</td> </tr> <tr> <td></td> </tr> <tr> <td>R</td> </tr> </table>	Device Information	R/W		R
Device Information	R/W					
	R					
10h-30h	32	<table border="1"> <tr> <td rowspan="3" style="text-align: center; vertical-align: middle;">Device Specific Data</td> <td>R/W</td> </tr> <tr> <td></td> </tr> <tr> <td>R</td> </tr> </table>	Device Specific Data	R/W		R
Device Specific Data	R/W					
	R					



31h-34h	4	Proximity Status Bytes	R/W
			R
35h-38h	4	Touch Status Bytes	R/W
			R
39h-3Ch	4	Halt Bytes	R/W
			R
3Dh-41h	4	Active Bytes (indicate cycle)	R/W
			R
42h-82h	64	Counts	R/W
			R
83h-C3h	64	LTAs	R/W







31H	Proximity 0 (CH0)								R/W	
	Bit	7	6	5	4	3	2	1	0	
		SHOW_RESET							CH0	R

### 9.5.4 Touch Status Bytes

The touch status of all the channels on the device are shown here.

35H	Touch 0 (CH1-CH6)								R/W	
	Bit	7	6	5	4	3	2	1	0	
			CH6	CH5	CH4	CH3	CH2	CH1		R

### 9.5.5 Halt Bytes

The filter halt status of all the channels on the device are shown here.

39H	Halt 0 (CH0-CH6)								R/W	
	Bit	7	6	5	4	3	2	1	0	
			CH6	CH5	CH4	CH3	CH2	CH1	CH0	R

**Channel Number (indicate cycle the channel number that the data in this cycles represents)**

3DH	CHAN_NUM								R/W	
	Bit	7	6	5	4	3	2	1	0	
										R

### 9.5.6 Counts

The values that are available here are only the transfers from the current cycle.

42H	Count								R/W	
	Bit	7	6	5	4	3	2	1	0	
		HIGH byte								R

43H	Count								R/W	
	Bit	7	6	5	4	3	2	1	0	
		LOW byte								R



### 9.5.7 Long-Term Averages

The values that are available here are only the transfers from the current cycle.

83H	Long-Term Average								R/W	
	Bit	7	6	5	4	3	2	1	0	
	HIGH byte								R	

84H	Long-Term Average								R/W	
	Bit	7	6	5	4	3	2	1	0	
	LOW byte								R	

### 9.5.8 Device Settings

It is attempted that the common used settings are situated closer to the top of the memory block. Settings that are regarded as more 'once-off' are placed further down.

C4H	Channel 0 Compensation Setting								R/W	
	Bit	7	6	5	4	3	2	1	0	
	Compensation 0 <5:0>								R/W	

Comp5:Comp0	Sets the compensation value for channel 0
	Can set the counts outside the ATI routine limit if "ATI OFF" is not set. This event will trigger re-ATI.

C5H	Channel 1 Compensation Setting								R/W	
	Bit	7	6	5	4	3	2	1	0	
	Compensation 1 <5:0>								R/W	



Comp5:Comp0	Sets the compensation value for channel 1
	Can set the counts outside the ATI routine limit if “ATI OFF” is not set. This event will trigger re-ATI.

**C6H**

Channel 2 Compensation Setting									R/W
Bit	7	6	5	4	3	2	1	0	
	Compensation 2 <5:0>								R/W

Comp5:Comp0	Sets the compensation value for channel 2
	Can set the counts outside the ATI routine limit if “ATI OFF” is not set. This event will trigger re-ATI.

**C7H**

Channel 3 Compensation Setting									R/W
Bit	7	6	5	4	3	2	1	0	
	Compensation 3 <5:0>								R/W

Comp5:Comp0	Sets the compensation value for channel 3
	Can set the counts outside the ATI routine limit if “ATI OFF” is not set. This event will trigger re-ATI.

**C8H**

Channel 4 Compensation Setting									R/W
Bit	7	6	5	4	3	2	1	0	
	Compensation 4 <5:0>								R/W



Comp5:Comp0	Sets the compensation value for channel 4
	Can set the counts outside the ATI routine limit if “ATI OFF” is not set. This event will trigger re-ATI.

C9H

Channel 5 Compensation Setting									R/W
Bit	7	6	5	4	3	2	1	0	
	Compensation 5 <5:0>								R/W

Comp5:Comp0	Sets the compensation value for channel 5
	Can set the counts outside the ATI routine limit if “ATI OFF” is not set. This event will trigger re-ATI.

CAH

Channel 6 Compensation Setting									R/W
Bit	7	6	5	4	3	2	1	0	
	Compensation 6 <5:0>								R/W

Comp5:Comp0	Sets the compensation value for channel 6
	Can set the counts outside the ATI routine limit if “ATI OFF” is not set. This event will trigger re-ATI.

CBH

Channel 0 Multiplier Setting									R/W
Bit	7	6	5	4	3	2	1	0	
	Multiplier 0 <4:0>								R/W

Multiplier Settings registers sets the Multiplier values for each channel, which determines the sensitivity, and compensation to reach ATI routine target.



Mul4:Mul3	Sensitivity Multiplier
Mul2:0	Compensation Multiplier
	Can set the counts outside the ATI routine limit if “ATI OFF” is not set. This event will trigger re-ATI.

**CCH**

CH1 Touch Threshold									R/W
Bit	7	6	5	4	3	2	1	0	
	TTH2	TTH1	TTH0	Multiplier 1 <4:0>					R/W

**CDH**

CH2 Touch Threshold									R/W
Bit	7	6	5	4	3	2	1	0	
	TTH2	TTH1	TTH0	Multiplier 2 <4:0>					R/W

**CEH**

CH3 Touch Threshold									R/W
Bit	7	6	5	4	3	2	1	0	
	TTH2	TTH1	TTH0	Multiplier 3 <4:0>					R/W

**CFH**

CH4 Touch Threshold									R/W
Bit	7	6	5	4	3	2	1	0	
	TTH2	TTH1	TTH0	Multiplier 4 <4:0>					R/W

**D0H**

CH5 Touch Threshold									R/W
Bit	7	6	5	4	3	2	1	0	
	TTH2	TTH1	TTH0	Multiplier 5 <4:0>					R/W



D1H

CH6 Touch Threshold									R/W
Bit	7	6	5	4	3	2	1	0	
	TTH2	TTH1	TTH0	Multiplier 6 <4:0>					R/W

Bits	Selection (TTH_Range = 0)	Selection (TTH_Range = 1)
000	96	24
001	32	8
010	64	16
011	128	32
100	196	48
101	256	64
110	384	96
111	512	128

D2H

Proximity Sensitivity Settings (PROX_TH_CH0)									R/W
Bit	7	6	5	4	3	2	1	0	
			PT_5	PT_4	PT_3	PT_2	PT_1	PT_0	R/W

Custom value between 1 and 63 can be set with bit 5:0 to implement the Proximity Threshold. The default Prox Threshold of the IQS156 is 4.

D3H

Touch Treshold Range Selection Bits – CH1-CH6 (TTH_RANGE)									R/W
Bit	7	6	5	4	3	2	1	0	
		CH6 Low Range	CH5 Low Range	CH4 Low Range	CH3 Low Range	CH2 Low Range	CH1 Low Range		R/W
Default		0	0	0	0	0	0		



CH7 low Range:CH0 low Range	Select the low or normal range for Touch Thresholds: ‘0’: Low Range ‘1’: Normal Range
-----------------------------	---

**D4H**

ProxSense Module Settings 0 (PROX_SETTINGS0)									R/W
Bit	7	6	5	4	3	2	1	0	
		ATI OFF	Partial ATI				Base 1	Base 0	R/W

ATI OFF	If this bit is set, the ATI routine will not be able to run: ‘0’: Disabled ‘1’: Enabled
Partial ATI	Disables the Base bits to set the base value for the Prox Channel “0”: Enabled “1”: Disabled
Base1:Base0	Controls the base value for the ATI routine of the Prox channel, if Partial ATI = 0: ‘00’: 200 ‘01’: 50 ‘10’: 150 ‘11’: 250

**D5H**

ProxSense Module Settings 1 (PROX_SETTINGS1)									R/W
Bit	7	6	5	4	3	2	1	0	
				ND_ LEVEL	ND_ ON	FORCE_ HALT	Redo_ ATI	Reseed	R/W



ND Level	Selects the noise detect level ‘0’: 25mV ‘1’: 50mV
ND On	Enables the noise detection. ‘0’: Disabled ‘1’: Enabled
Force Halt	Forces the Long Term Average to stop being calculated ‘0’: LTA updates normally ‘1’: LTA is halted
Redo ATI	Forces the ATI routine to run when a ‘1’ is written into this bit position. ATI OFF in D4 should not be set.
Reseed	All channels are reseeded when a ‘1’ is written into this bit position. The LTA’s are set to 8 counts above the counts.

**D6H**

	ProxSense Module Settings 2 (PROX_SETTINGS2)								R/W
Bit	7	6	5	4	3	2	1	0	
	Ack Reset	WDT Off	Sync On	Halt1	Halt0	LP2	LP1	LP0	R/W





Ack Reset	Clears the "RESET" indication flag
WDT Off	Sets the watchdog timer: 0 = Enabled 1 = Disabled
Sync On	Sync on Data line 0 = OFF 1 = ON (IQS156 will pulse the SDA line low when comms window is open)
Halt1:Halt0	Sets the Halt time for the LTA (time before recalibration): 00 = 20 Seconds 01 = 40 Seconds 10 = Never 11 = Permanent
LP2:LP0	Controls the charge cycle time: 000 = 9ms 001 = 128ms 010 = 256ms 011 = 384ms 100 = 512ms 101 = 768ms 110 = 1s 111 = 2s

D7H

Channel Enable for CH0 – CH6 (CHAN_ACTIVE)									R/W
Bit	7	6	5	4	3	2	1	0	
		CH6	CH5	CH4	CH3	CH2	CH1	CH0	R/W



CH6:CH0	Software enable or disable of channels: 0 = Channel Disabled 1 = Channel Enabled
---------	--

<b>D8H</b>	<b>DEFAULT_COMMS_POINTER</b>								<b>R/W</b>	
	<b>Bit</b>	<b>7</b>	<b>6</b>	<b>5</b>	<b>4</b>	<b>3</b>	<b>2</b>	<b>1</b>	<b>0</b>	
	Default	10H (beginning of Device Specific Data)								R/W

<b>FCH</b>	<b>Direct Address R/W</b>								<b>R/W</b>	
	<b>Bit</b>	<b>7</b>	<b>6</b>	<b>5</b>	<b>4</b>	<b>3</b>	<b>2</b>	<b>1</b>	<b>0</b>	
		Address location to perform Direct Read/Write								R/W

<b>FDH</b>	<b>Direct Data R/W</b>								<b>R/W</b>	
	<b>Bit</b>	<b>7</b>	<b>6</b>	<b>5</b>	<b>4</b>	<b>3</b>	<b>2</b>	<b>1</b>	<b>0</b>	
		Data to Read/Write								R/W

## 10 Auto Tuning Implementation (ATI)

ATI is a sophisticated technology implemented in the latest generation ProxSense® devices that optimises the performance of the sensor in a wide range of applications and environmental conditions (refer to application note AZD0027 - Auto Tuning Implementation).

ATI makes adjustments through external reference capacitors (as required by most other solutions) to obtain optimum performance.

ATI adjusts internal circuitry according to two parameters, the ATI multiplier and the ATI compensation. The ATI multiplier can be viewed as a course adjustment and the ATI compensation as a fine adjustment.

The adjustment of the ATI parameters will result in variations in the count and sensitivity. Sensitivity can be observed as the change in count as the result of a fixed change in sensed capacitance. The ATI parameters have been chosen to provide significant overlap. It may therefore be possible to select various combinations of ATI multiplier and ATI compensation settings to obtain the same count. The sensitivity of the various options may however be different for the same count.

### 10.1 Automatic ATI

The IQS156 implements an automatic ATI algorithm. This algorithm automatically adjusts the ATI parameters to optimise the sensing electrodes' connection to the device.

The device will execute the ATI algorithm whenever the device starts-up and when the counts are not within a predetermined range.



While the Automatic ATI algorithm is in progress this condition will be indicated in the streaming data and proximity and touch events cannot be detected. The device will only briefly remain in this condition and it will be entered only when relatively large shifts in the count has been detected.

The automatic ATI function aims to maintain a constant count, regardless of the capacitance of the sense electrode (within the maximum range of the device).

The effects of auto-ATI on the application are the following:

- ⌚ Automatic adjustment of the device configuration and processing parameters for a wide range of PCB and application designs to maintain an optimal configuration for proximity and touch detection.
- ⌚ Automatic tuning of the sense electrode at start-up to optimise the sensitivity of the application.
- ⌚ Automatic re-tuning when the device detects changes in the sensing electrodes' capacitance to accommodate a large range of changes in the environment of the application that influences the sensing electrodes.
- ⌚ Re-tuning only occurs during device operation when a relatively large sensitivity reduction is detected. This is to ensure smooth operation of the device during operation.
- ⌚ Re-tuning may temporarily influences the

normal functioning of the device, but in most instances the effect will be hardly noticeable.

Shortly after the completion of the re-tuning process the sensitivity of Proximity detection may be reduced slightly for a few seconds as internal filters stabilises.

Automatic ATI can be implemented so effectively due to:

- ⌚ Excellent system signal to noise ratio (SNR).
- ⌚ Effective digital signal processing to remove AC and other noise.
- ⌚ The very stable core of the devices.
- ⌚ The built in capability to accommodate a large range of sensing electrode capacitances.

## 10.2 Partial ATI

By default (Address: D4H bit 5 = 0) the ATI routine sets the required base value of the touch channels to 250 counts. The required base value for the proximity channel is specified through I<sup>2</sup>C commands in address D3H bits [1:0] and is default 200.

Alternatively (Address: D4H bit 5 = 1), the user can set the multiplier bits through address CBH through D1H bits [5:0] and this would determine the sensitivity, and compensation (scaled) to reach the ATI target.

With the base value set, the Partial ATI routine would use a convergence technique with a fixed amount of steps to reach its aimed value.



## 11 Specifications

### 11.1 Absolute Maximum Specifications

The following absolute maximum parameters are specified for the device:

*Exceeding these maximum specifications may cause damage to the device.*

⌚ Operating temperature	-40°C to 85°C
⌚ Supply Voltage (VDDHI – GND)	5.5V
⌚ Maximum pin voltage	VDDHI + 0.5V
⌚ Maximum continuous current (for specific Pins)	
⌚ Minimum pin voltage	GND - 0.5V
⌚ Minimum power-on slope	100V/s
⌚ ESD protection	±3kV
⌚ Maximum pin temperature during soldering	
⌚ Maximum body temperature during soldering	

**Table 11.1 IQS156 General Operating Conditions<sup>1</sup>**

DESCRIPTION	Conditions	PARAMETER	MIN	TYP	MAX	UNIT
Supply voltage		V <sub>DDHI</sub>	2.95		5.50	V
Internal regulator output	2.95 ≤ V <sub>DDHI</sub> ≤ 5.0	V <sub>REG</sub>	2.35	2.50	2.65	V
Boost mode operating current	3.3V	I <sub>IQS156_BP</sub>		230		μA
Normal operating current	3.3V	I <sub>IQS156_NP</sub>		17		μA
Low Power Operating current	3.3V	I <sub>IQS156_LP1</sub>		11		μA
Low Power Operating current	3.3V	I <sub>IQS156_LP2</sub>		9		μA
Low Power Operating current	3.3V	I <sub>IQS156_LP3</sub>		8		μA
Low Power Operating current	3.3V	I <sub>IQS156_LP4</sub>		7		μA
Low Power Operating current	3.3V	I <sub>IQS156_IP5</sub>		6.5		μA
Low Power Operating current	3.3V	I <sub>IQS156_IP6</sub>		<6		μA

<sup>1</sup> Operating current figure shown here, do not include current flow through I<sup>2</sup>C pull up resistors.



**Table 11.2 Start-up and shut-down slope Characteristics**

DESCRIPTION	Conditions	PARAMETER	MIN	MAX	UNIT
POR	V <sub>DDHI</sub> Slope ≥ 100V/s	POR	0.92	2.3	V
BOD		BOD	1	1.54	V

**Table 11.3 Initial Touch Times**

DESCRIPTION	PARAMETER	MIN	MAX	Unit
BP <sup>1</sup>	Report Rate	117	223	ms
NP	Report Rate	126	252	ms
LP6	Report Rate	126	2124	ms

**Table 11.4 Repetitive Touch Rates**

DESCRIPTION	Conditions	PARAMETER	Sample rate = 5ms	Sample rate = 9ms	UNIT
All power modes	Zoom active	Response Rate <sup>2</sup>	>5	>2	Touches/second

The sample rate of the IQS156 is increased by:

- Faster communication
- Less data transfer

<sup>1</sup> Communication and charge frequency to comply with sample rate as reported earlier in this datasheet.

<sup>2</sup> Debounce of 3 (up and down)



## 12 Mechanical Dimensions

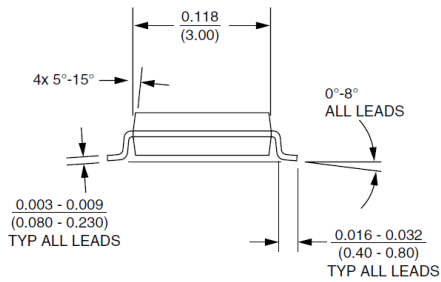

Figure 12.1 MSOP-10 Back view.

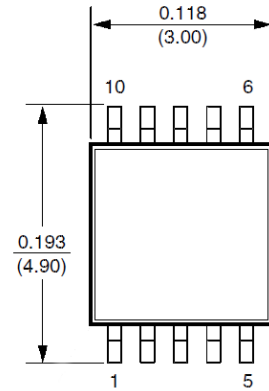

Figure 12.3 MSOP-10 Top view.

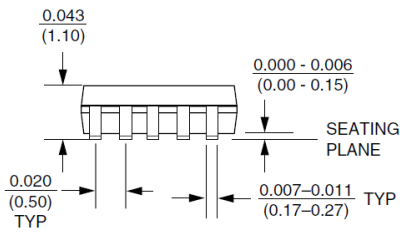

Figure 12.2 MSOP-10 Side view.

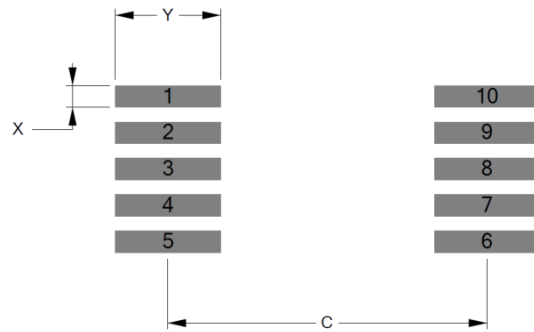

Figure 12.4 MSOP-10 Footprint.

Table 12.1 MSOP-10 Footprint Dimensions from Figure 12.4.

Dimension	[mm]
Pitch	0.50
C	4.40
Y	1.45
X	0.30



### 13 Device Marking

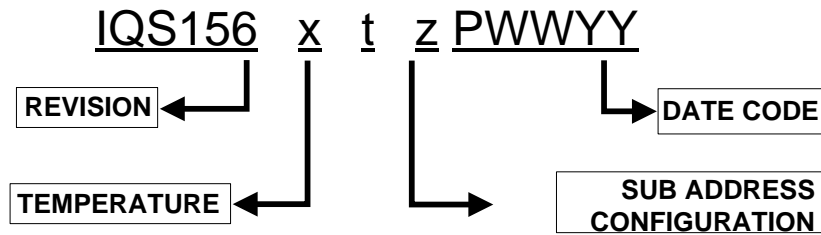

<b>REVISION</b>		<b>x</b>	=	IC Revision Number
<b>TEMPERATURE RANGE</b>	<b>t</b>		=	I -40°C to 85°C (Industrial) C 0°C to 70°C (Commercial)
<b>IC CONFIGURATION</b>		<b>z</b>	=	Configuration (Hexadecimal)
<b>DATE CODE</b>		<b>P</b>	=	Package House
		<b>WW</b>	=	Week
		<b>YY</b>	=	Year

### 14 Ordering Information

Orders will be subject to a MOQ (Minimum Order Quantity) of a full reel. Contact the official distributor for sample quantities. A list of the distributors can be found under the “Distributors” section of [www.azoteq.com](http://www.azoteq.com).

For large orders, Azoteq can provide pre-configured devices.

The Part-number can be generated by using USBProg.exe or the Interactive Part Number generator on the website.

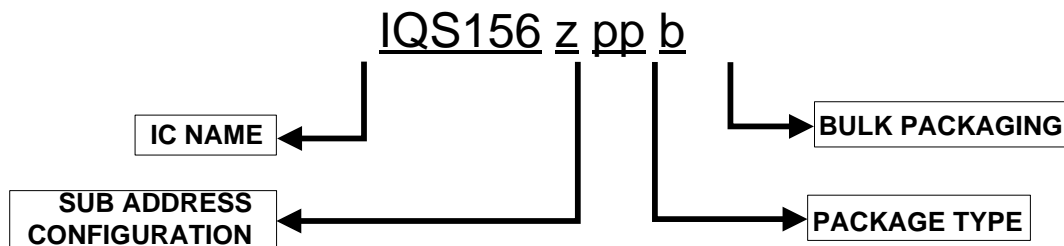

<b>IC NAME</b>		<b>IQS156</b>	=	IQS156
<b>CONFIGURATION</b>	<b>z</b>		=	Sub Address Configuration (hexadecimal)
<b>PACKAGE TYPE</b>		<b>MS</b>	=	MSOP-10
<b>BULK PACKAGING</b>	<b>R</b>		=	Reel (4000pcs/reel) – MOQ = 4000pcs
		<b>T</b>	=	Tube (96pcs/tube)



## 15 Contact Information

### PRETORIA OFFICE

Physical Address  
160 Witch Hazel Avenue  
Hazel Court 1, 1<sup>st</sup> Floor  
Highveld Techno Park  
Centurion, Gauteng  
Republic of South Africa  
Tel: +27 12 665 2880  
Fax: +27 12 665 2883  
Postal Address  
PO Box 16767  
Lytelton  
0140  
Republic of South Africa

### PAARL OFFICE

Physical Address  
109 Main Street  
Paarl  
7646  
Western Cape  
Republic of South Africa  
Tel: +27 21 863 0033  
Fax: +27 21 863 1512  
Postal Address  
PO Box 3534  
Paarl  
7620  
Republic of South Africa

The following patents relate to the device or usage of the device: US 6,249,089 B1, US 6,621,225 B2, US 6,650,066 B2, US 6,952,084 B2, US 6,984,900 B1, US 7,084,526 B2, US 7,084,531 B2, US 7,119,459 B2, US 7,265,494 B2, US 7,291,940 B2, US 7,329,970 B2, US 7,336,037 B2, US 7,443,101 B2, US 7,466,040 B2, US 7,498,749 B2, US 7,528,508 B2, US 7,755,219 B2, US 7,772,781, US 7,781,980 B2, EP 1 120 018 B1, EP 1 206 168 B1, EP 1 308 913 B1, EP 1 530 178 B1, ZL 99 8 14357.X, AUS 761094

**IQ Switch®**, **ProxSense™**, **LightSense™**, **AirButton®** and the **IQ Logo** are trademarks of Azoteq.

The information appearing in this Datasheet is believed to be accurate at the time of publication. However, Azoteq assumes no responsibility arising from the use of the specifications described. The applications mentioned herein are used solely for the purpose of illustration and Azoteq makes no warranty or representation that such applications will be suitable without further modification, nor recommends the use of its products for application that may present a risk to human life due to malfunction or otherwise. Azoteq products are not authorized for use as critical components in life support devices or systems. No licenses to patents are granted, implicitly or otherwise, under any intellectual property rights. Azoteq reserves the right to alter its products without prior notification. For the most up-to-date information, please refer to [www.azoteq.com](http://www.azoteq.com).

**WWW.AZOTEQ.COM**

**ProxSenseSupport@azoteq.com**



# Mouser Electronics

Authorized Distributor

Click to View Pricing, Inventory, Delivery & Lifecycle Information:

[Azoteq:](#)

[IQS156MSR](#)